

Communications Co. Inc. eqpt pg 90

electronics

radio, communication, industrial applications of electron tubes . . . engineering and manufacture

FEBRUARY • 1941

PRICE 50 CENTS

McGraw-Hill Publishing Company, Inc.

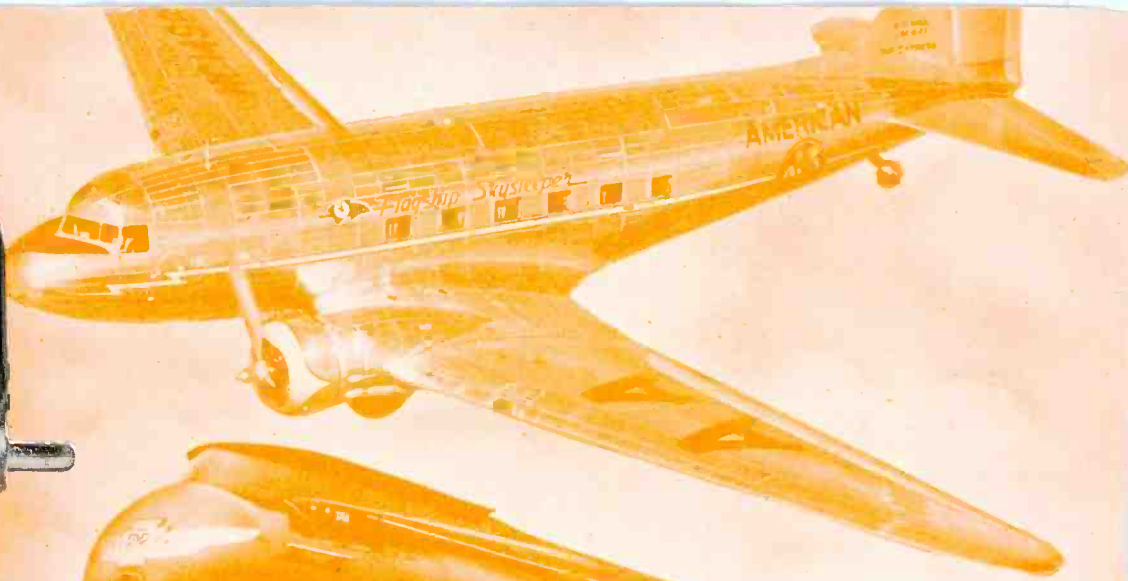
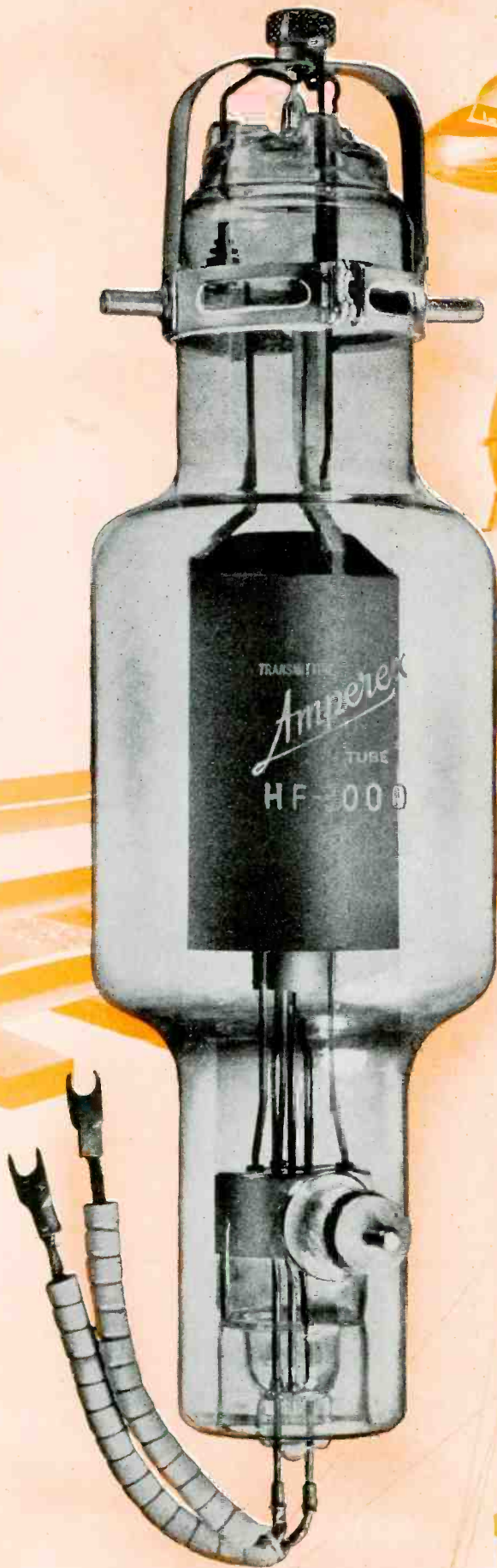

BOTTLENECK?

With huge orders for national defense and private industry placing a severe strain upon productive capacities, many engineers, perhaps even you, have become reconciled to accepting delays that seem unavoidable.

Fortunately, AMPEREX facilities are restricted solely to the design and manufacture of Vacuum Transmitting Tubes.

Here you'll find thousands of "bottles" . . . but not a single engineering or production "bottleneck."

AMPEREX is a transmitting tube manufacturer with no other interests to divert it from maintaining its rigid standards. No promises of greener pastures elsewhere can lure it from this concentration of effort.

AMPEREX has met and will continue to meet all demands upon its engineering and production facilities . . . provided these demands are for tubes.

AMPEREX REMAINS YOUR IMMEDIATE AND DEPENDABLE SOURCE OF SUPPLY

More than 100 types of tubes for use in Commercial Broadcasting, Point to Point Communication, Ultra High Frequency Transmission, Electro Medical Apparatus, High Voltage Rectification and many Industrial Applications.

AMPEREX ELECTRONIC PRODUCTS, Inc.

79 WASHINGTON STREET

BROOKLYN, NEW YORK



A McGRAW-HILL PUBLICATION

electronics

CONTENTS—FEBRUARY, 1941

KEITH HENNEY
Editor

Donald G. Fink
Managing Editor

Beverly Dudley **Craig Walsh**
Contributing Editor Associate Editor

M. L. Mathey **J. M. Heron**
Assistant Editor Assistant Editor

Harry Phillips
Art Director

H. W. MATEER
Manager

Wallace B. Blood
Sales Manager

Contents Copyright, 1941, by
McGraw-Hill Publishing Company, Inc.

McGRAW-HILL
PUBLISHING COMPANY, INC.

JAMES H. McGRAW
Founder and Honorary Chairman

Publication Office
99-129 North Broadway, Albany, N. Y., U. S. A.

Editorial and Executive Offices
330 West 42nd St., New York, N. Y., U.S.A.

James H. McGraw, Jr., President
Howard Ehrlich, Executive Vice President
Mason Britton, Vice Chairman
B. R. Putnam, Treasurer
D. C. McGraw, Secretary
J. E. Blackburn, Jr., Director of Circulation

Cable Address:
McGRAWHILL, New York
Member A. B. P. Member A. B. C.

SAVING FINGERS Cover

The fingers of this press operator are protected from crushing by the Westinghouse phototube relay mounted on the bed of the press. If the light beam is broken by his hand as shown, the press cannot operate

NATIONAL TELEVISION SYSTEM COMMITTEE..... Frontispiece

Group photograph of the members of N.T.S.C. taken during the final meeting before presentation of its proposals to the F.C.C.

N.T.S.C. PROPOSES TELEVISION STANDARDS..... 17

A first hand report of the meeting at which the F.C.C. received recommendations on television standards from the all-industry committee set up for that purpose

SIXTEENTH ANNUAL I.R.E. CONVENTION..... 22

A report on the technical papers presented at the I.R.E. Convention in New York in January

IMPULSE NOISE IN F-M RECEPTION, by V. D. Landon..... 26

An investigation of impulsive noise problems in frequency modulation and recommendations for reducing such noise. Extensive use is made of oscillographic methods

MAGNETIC CONTACT RELAYS APPLIED TO SENSITIVE CONTROL, by Anthony H. Lamb..... 31

A discussion of problems associated with magnetic contact relays including methods of resetting after they have operated

BINAURAL TRANSMISSION ON A SINGLE CHANNEL, by Austin V. Eastman and John R. Woodyard..... 34

Two sets of sidebands, out of phase with each other by 90 degrees, are transmitted on a single channel. The two signals are separated in the receiver and fed to separate audio channels

SOUND IN MOTION PICTURES—II, by Nathan Levinson..... 37

The second installment of a review of progress of sound in the motion picture industry. The development of methods and equipment are described

BROADCASTING "ON LOCATION", by Donald F. Langham.... 40

Special events form an important part of the programs of many broadcasting stations. The methods in use at WFBL are described

RECEIVER INTERFERENCE CHART, by J. J. Adams..... 43

A reference sheet plotted for easy determination of the types of beat-frequency interference likely to occur in a two-gang receiver tuned to any frequency in the broadcast band

DEPARTMENTS

CROSTALK	15	TUBES	67
REFERENCE SHEET	43	THE ELECTRON ART	77
TUBES AT WORK.....	44	THE INDUSTRY IN REVIEW.....	90

INDEX TO ADVERTISERS..... 100

ELECTRONICS, February, 1941. Vol. 14, No. 2. Published monthly, price 50c a copy. Allow at least ten days for change of address. All communications about subscriptions should be addressed to the Director of Circulation, 330 West 42nd Street, New York, N. Y.
Subscription rates—United States and possessions, Canada, Mexico, Central and South American countries, \$5.00 a year, \$8.00 for two years, \$10.00 for three years. Great Britain and British Possessions 36 shillings for one year, 72 shillings for three years. All other countries \$6.00 for one year, \$12.00 for three years. Entered as Second Class matter, August 29, 1936, at Post Office, Albany, New York, under the Act of March 3, 1879. BRANCH OFFICES: 520 North Michigan Avenue, Chicago; 68 Post Street, San Francisco; Aldwych House, Aldwych, London, W.C. 2; Washington; Philadelphia; Cleveland; Detroit; St. Louis; Boston; Atlanta, Ga.

Now!

CENTRALAB'S ELF RADIOHM

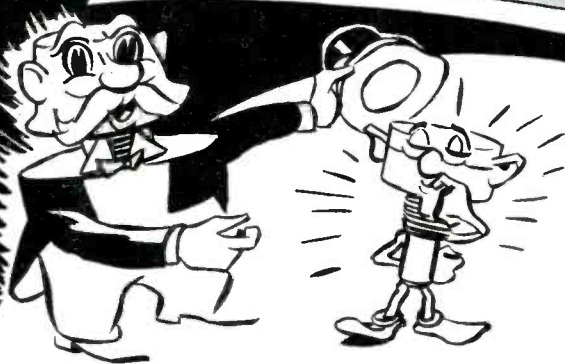

OLD Man Centralab presents his little brother . . . aptly called the ELF Radiohm.

Designed and constructed like the popular MIDGET Radiohm it has the added feature of still smaller size.

In spite of its small size it too features CENTRALAB'S long straight resistor strip in the inner circumference of the case . . . a particular advantage in producing good curve characteristics and low noise level on small controls.

Can be supplied with S.P.S.T. Switch with or without dummy lug. Switch rated at 2 Amperes at 125 volts. Underwriters approved.

TAP POSITIONS at 31, 44, 56 and 69% of rotation based on 300 degrees total rotation.

Send for Specification form 691

CENTRALAB: Div. of Globe-Union Inc.
MILWAUKEE, WISCONSIN

Centralab

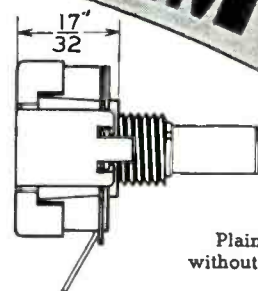

Plain ELF
without Switch

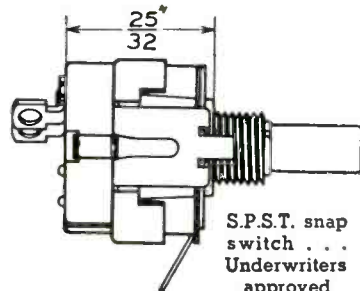

S.P.S.T. snap
switch . . .
Underwriters
approved

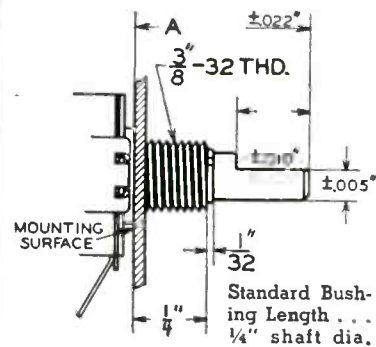

MOUNTING SURFACE

Standard Bushing Length . . .
1/4" shaft dia.

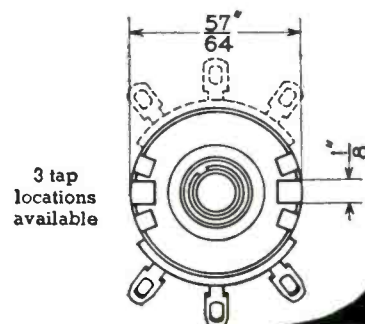

3 tap
locations
available

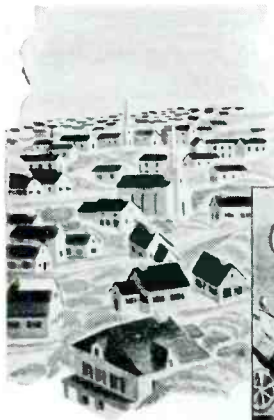

WHY...PUSHING A BUTTON CAN NOW! HEAT WATER IN 10,000 HOMES!

The home electric storage water heater is another device which has been simplified and made thoroughly practical by the unflinching contacts of the Sensitrol Relay. These heaters, equipped with Sensitrols, are controlled from the sub-station by a *carrier wave signal*, and operated during "off-peak" periods. This low impulse is sufficient to firmly close the relay contacts and thus control the "on" and "off" heater switch. Positive contact is certain... amplification is unnecessary... because of Sensitrol's *magnetic* contacting principle!

The WESTON SENSITROL RELAY

— employs an exclusive magnetic contacting principle... powerful magnetic contacts will positively complete a circuit of 110 volts AC or DC carrying 50 milliamperes, at operating values as low as 2 microamperes or 1 millivolt... no chattering or other contact troubles... operates directly from output of photo-cells, thermocouples, etc., without amplification... available with fixed or adjustable contact, manual or electrical reset... measures only 3 1/4" diameter.

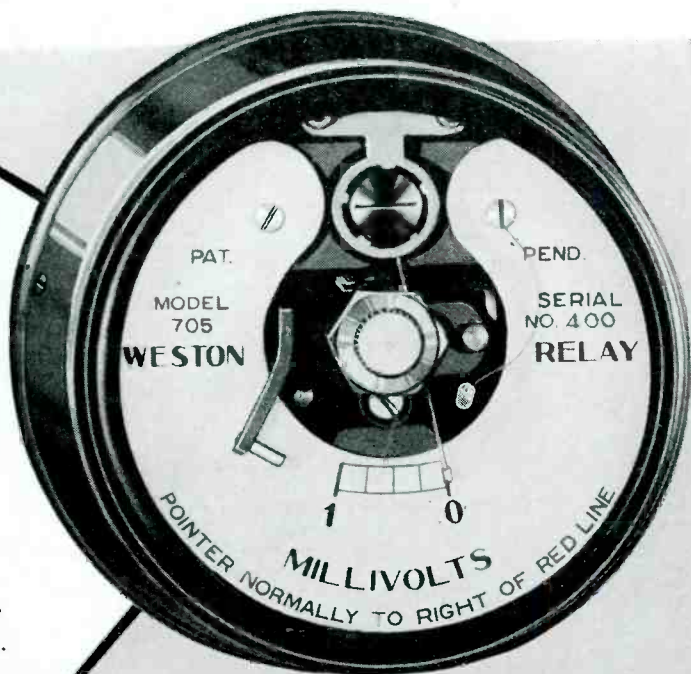

WHEN *You* LAY PLANS FOR A BETTER METHOD

... keep in mind these unusual characteristics of the Sensitrol. They may prove the "Open Sesame" to valuable devices beyond the horizons of known designs. Combining *high sensitivity* with *high contact capacity*, the Sensitrol already has made possible the development of simple, practical devices for controlling motors, heaters, traffic lighting,

safety alarms, and for numerous other problems of control. Why not have the complete story on Sensitrol... learn more about its application possibilities? Ask the WESTON sales representative in your vicinity, or write for literature to Weston Electrical Instrument Corporation, 618 Frelinghuysen Ave., Newark, New Jersey.

Laboratory Standards... Precision DC and AC Portables... Instrument Transformers... Sensitive Relays... DC, AC, and Thermo Switchboard and Panel Instruments.

WESTON

Specialized Test Equipment... Light Measurement and Control Devices... Exposure Meters... Aircraft Instruments... Electric Tachometers... Dial Thermometers.

FOR OVER 52 YEARS LEADERS IN ELECTRICAL MEASURING INSTRUMENTS

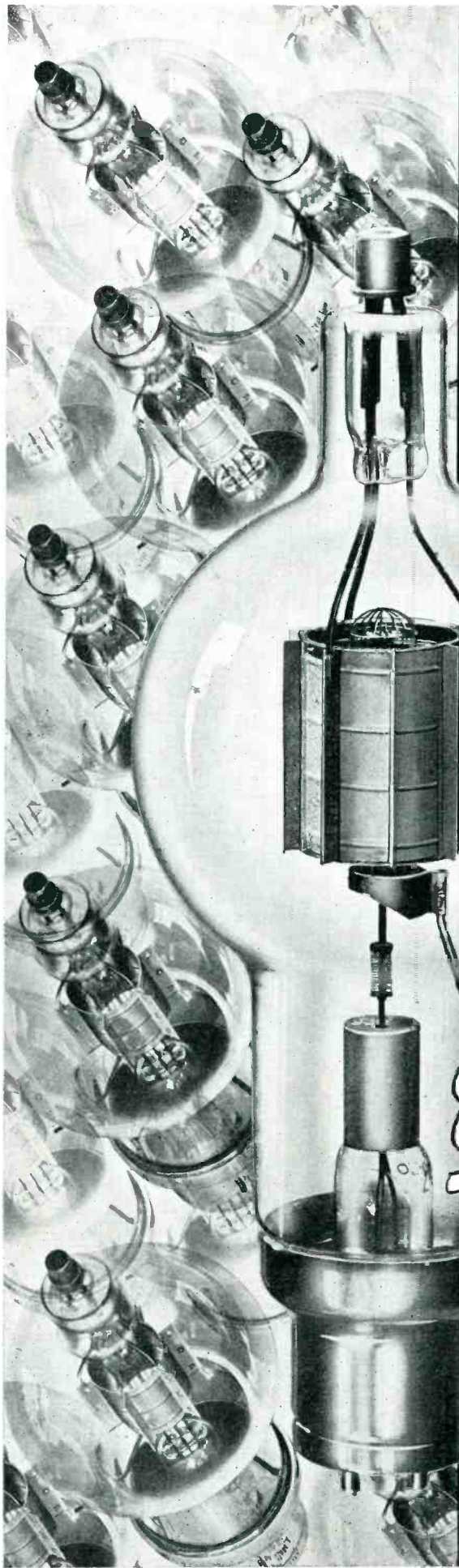

PERFORMANCE:

Unusual capabilities as yet unequalled in actual service. Used in hundreds of 1KW to 5KW stations up to 60 megacycles

DEPENDABILITY:

Many of the world's most important commercial stations report 10,000 to 15,000 hours of extremely superior service

ECONOMY:

Replaces tubes that cost more than twice as much . . . gives more watts of carrier and more watt-hours per dollar

When the Eimac 450T tube first made its appearance several years ago, some of radio's engineers scoffed at the idea of using so small a tube for such enormous powers as required for most commercial transmitters. It was a radical idea . . . unfeasible to their minds.

Today, however, it is a different story. This tube is now occupying the key sockets of some of the most important radio transmitters in the world. The ground stations in service for practically every major airline are built around the unusual capabilities of the Eimac 450T. Throughout the world hundreds of police radios and thousands of commercial transmitters requiring 1KW to 5KW output find the Eimac 450T vastly superior to most other tubes of like ratings. In Frequency Modulation too, Eimac tubes lead the way. This recognition is proof enough, not only of its feasibility but of the decided advantages to be gained by adopting Eimac tubes . . . the only tubes which are unconditionally guaranteed against failures caused by gas released internally.

Be sure you get the original, the tried and proven tube
LOOK FOR THE EIMAC SIGNATURE ON EACH BULB

Eimac 450T sets the pace in modern radio!

EIMAC REPRESENTATIVES

California, Nevada
 HERB BECKER, 1530 W.
 104th St., Los Angeles, Cal.
 Wash., Ore., Idaho, Mont.
 GENERAL SALES CO.,
 Verner O. Jensen, 2605-07
 Second Ave., Seattle, Wash.
 Colo., Wyo., New Mexico,
 Arizona, Utah
 RICHARD A. HYDE, 4253
 Quitman St., Denver, Colo.
 Ohio, Mich., Ky., Ind., Minn.,
 Mo., Kan., Neb., Iowa
 PEEL SALES ENGINEER-
 ING CO., E. R. Peel, 154
 E. Erie St., Chicago, Ill.

N. Y., N. J., Penn., Md., Del.,
 Dist. of Col., Maine, N. H.
 R. I., Conn., Mass.
 ADOLPH SCHWARTZ,
 14726 Elm Ave., Flushing,
 New York.

Texas, La., Okla., Ark.
 J. EARL SMITH, 2821 Live
 Oak St., Dallas, Texas.

Chicago, Illinois, Wisconsin
 G. G. RYAN, 549 W.
 Washington Blvd., Chicago,
 Ill.

N. Caro., S. Caro., Georgia,
 Tenn., Flor., Ala., Miss.
 JAMES MILLAR, 316 Ninth
 St. N. E., Atlanta, Georgia.

Eitel-McCullough, Inc. San Bruno, Calif.

HOW LAPP DOUBLED THE STRENGTH OF THE PORCELAIN COMPRESSION CONE, WITHOUT CHANGING DIMENSIONS, WALL THICKNESS OR WEIGHT

The advance of modern industrial science has been achieved largely through making minute changes in physical or chemical form to effect tremendous changes

in performance characteristics. Consider the matter of steel. *If you know how*, you can take a pound of common nails, add about $\frac{1}{8}$ ounce of carbon and make tool steel with double the tensile strength and five times the hardness.

*** As pioneers in radio tower insulation, Lapp men had to develop whole new engineering conceptions. Recognizing early that the tremendous mechanical loads could be carried by porcelain loaded only in compression, they developed the porcelain compression cone

for use in all types of footing and guy insulators. And, then, not content with their first efforts along these lines, they set out to improve the design—

with the result that by changing slightly the contour of the cone, they *doubled the strength of the insulators*. *** It's the *know-how* of Lapp engineers that has kept Lapp the dominant force in insulation for radio broadcast. Today, if you

contemplate installation of a new transmitter, or modernization of present equipment, you can't afford not to consider Lapp for tower footing and guy insulators, for porcelain water cooling systems, for pressure gas-filled condensers.

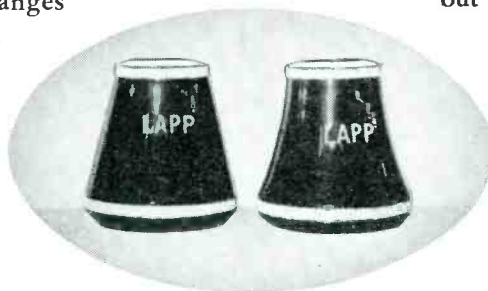

Left, early Lapp Compression Cone. Right, curved side compression cone—same dimensions, wall thickness and weight—twice the compression strength of the straight side cone—the design used in all footing and guy insulators (see below) since 1932.



LAPP

INSULATOR CO., INC., LE ROY, N. Y., U. S. A.

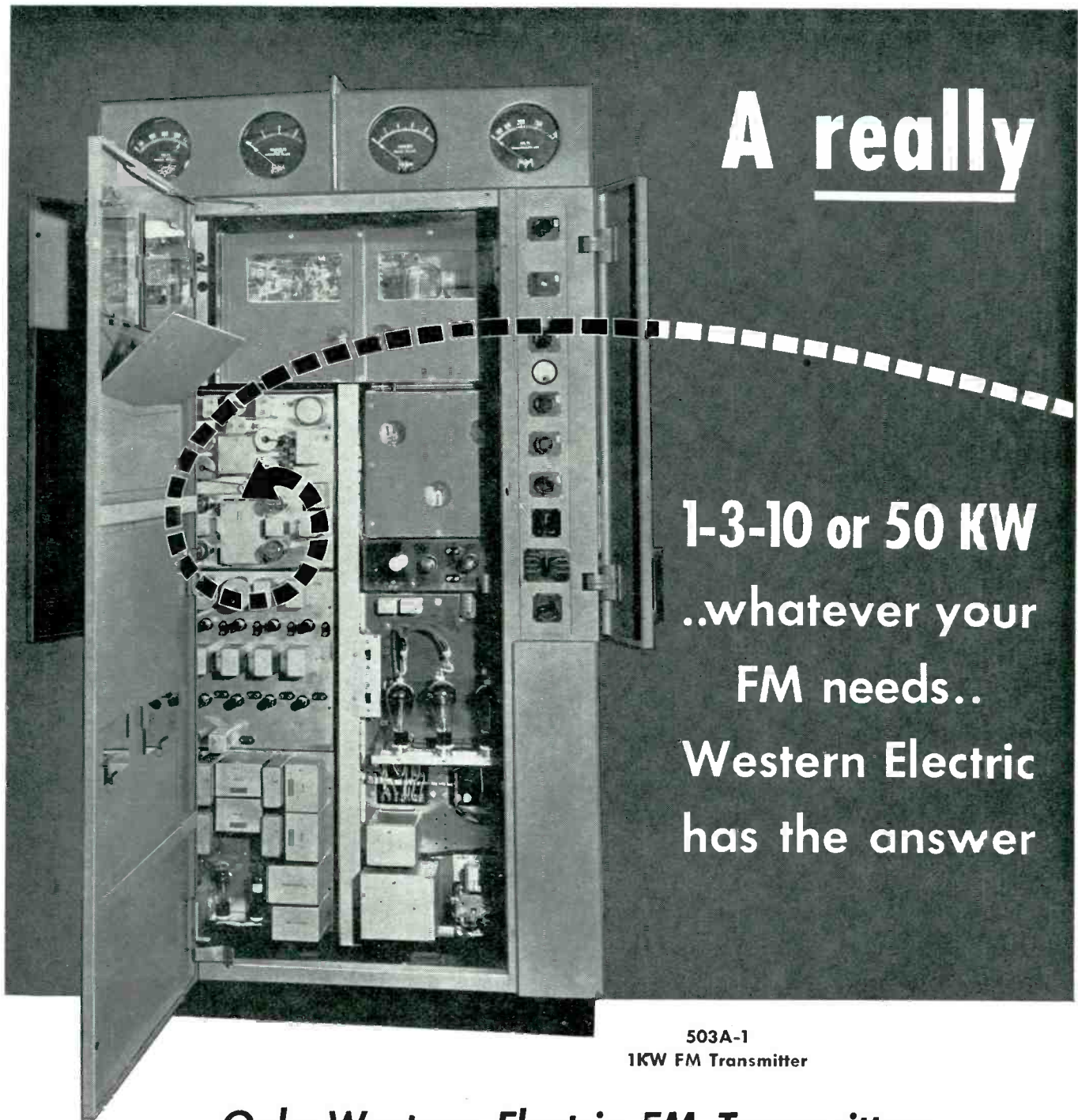

A really

1-3-10 or 50 KW
 ..whatever your
 FM needs..
 Western Electric
 has the answer

503A-1
 1KW FM Transmitter

**Only Western Electric FM Transmitters
 have these 7 outstanding features:**

- 1** The factors and circuit elements which control the modulation capabilities and those that control the carrier frequency stability are completely isolated in their action.
- 2** The electrical circuits used in the process of controlling a high frequency generator with a stable low frequency oscillator are not in the program transmission path and, therefore, their adjustments do not affect the character of the transmitted wave.
- 3** The application of a balanced electric oscillator and reactance control tube circuit permits wide frequency excursions while using only a small and linear por-

tion of the reactance control tube mutual conductance-grid bias characteristic.

- 4** Negative feedback in the modulated oscillator circuit minimizes distortion that otherwise results from amplitude modulation of the wave applied to the reactance control tube grids.
- 5** Because of (1) to (4) a high degree of linearity is obtained in the modulation characteristics over a frequency deviation range of ± 150 kilocycles. This large linear range obviates the need for critical circuit adjustments to obtain consistently low harmonic distortion over the smaller range

required in practice. For the frequency deviation of ± 75 kilocycles, required in practice, the measured RMS harmonic distortion is less than 1% for all signal frequencies between 30 and 15,000 C. P. S.

- 6** The carrier frequency stability is exactly that of a single crystal controlled oscillator and is independent of any other circuit variations.
- 7** Since the carrier frequency stability is that of a newly developed low temperature coefficient crystal, the need for temperature control equipment is completely eliminated.

great contribution to FM

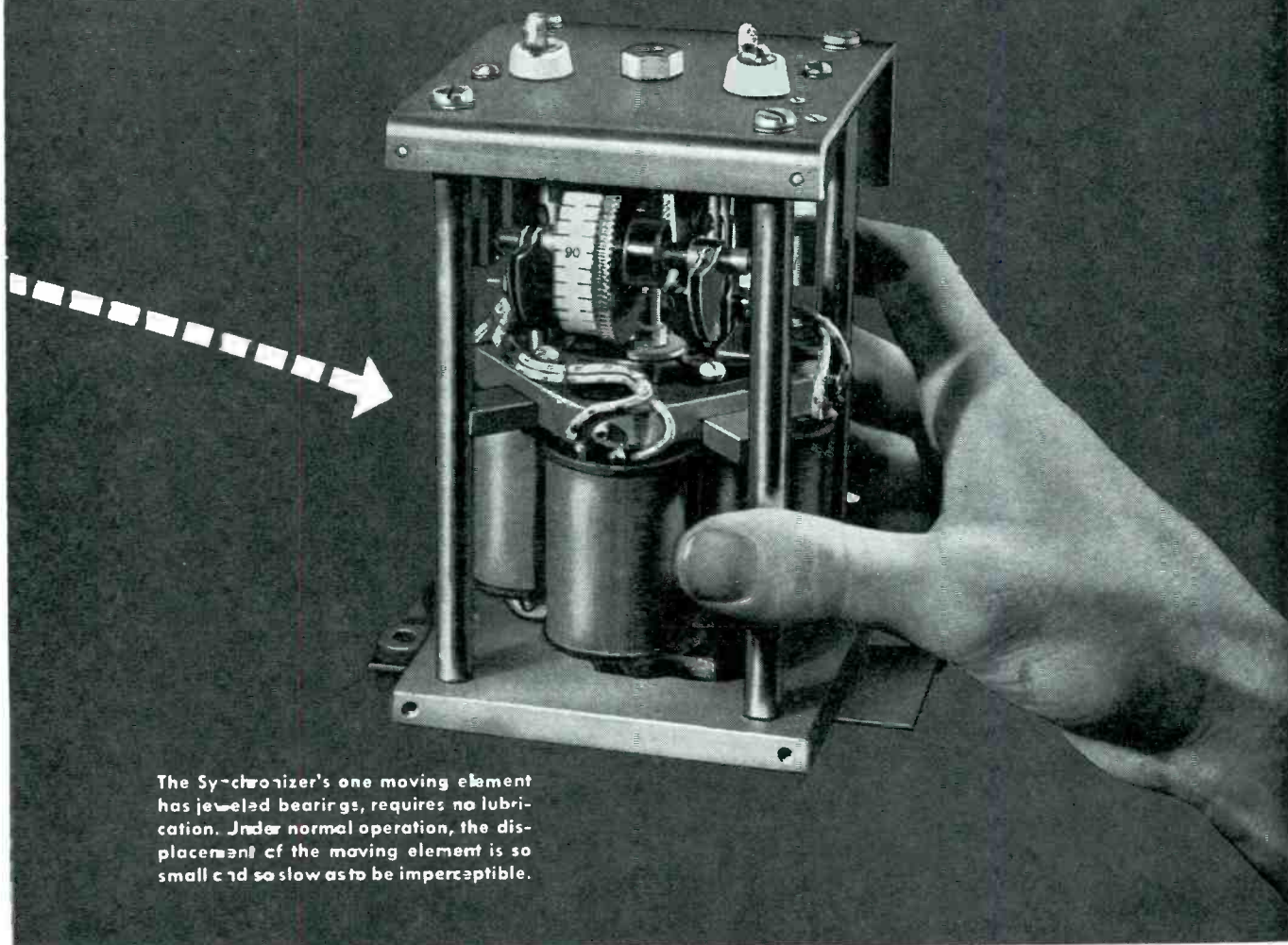

The Synchronizer's one moving element has jeweled bearings, requires no lubrication. Under normal operation, the displacement of the moving element is so small and so slow as to be imperceptible.

The Western Electric **SYNCHRONIZER**

In Western Electric *Synchronized FM* Transmitters, the mean carrier frequency is continuously and precisely maintained by a single low temperature coefficient crystal.

The Synchronizer compensates *immediately and automatically* for a change in the mean frequency of the modulated oscillator arising from any cause such as temperature changes or even violent disturbances that might arise if tube failures should occur. It eliminates completely the

need for frequent checking of the transmitter circuits and manual readjustment of frequency controlling elements.

Developed by Bell Telephone Laboratories for use in frequency standard work, the Synchronizer is uncannily accurate—an outstanding contribution to the new art of FM broadcasting!

For further details: Graybar Electric Company, Graybar Bldg., New York, N. Y.



Western Electric

**A
FEW
SECONDS
A
YEAR**

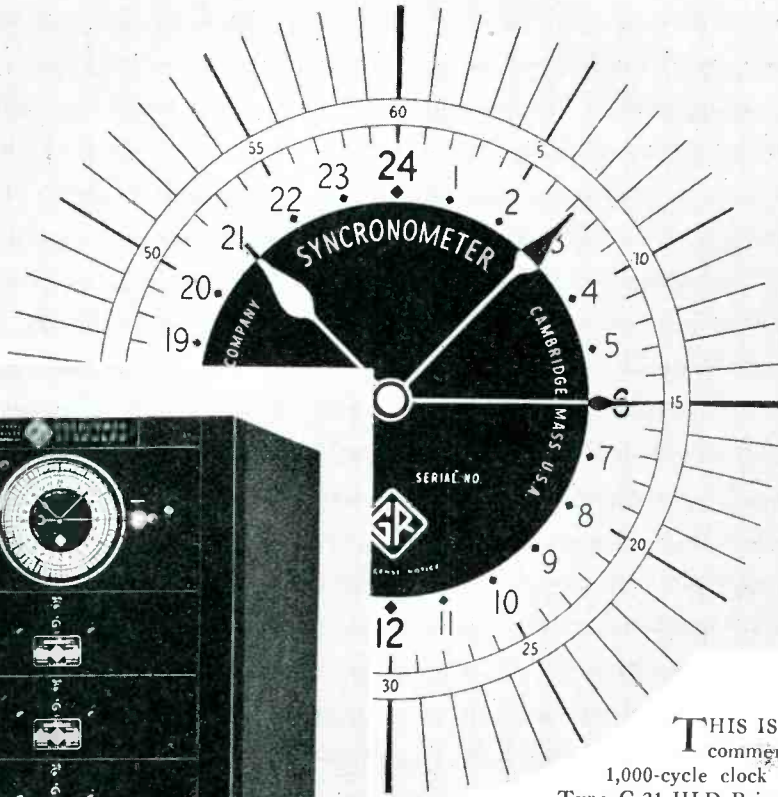
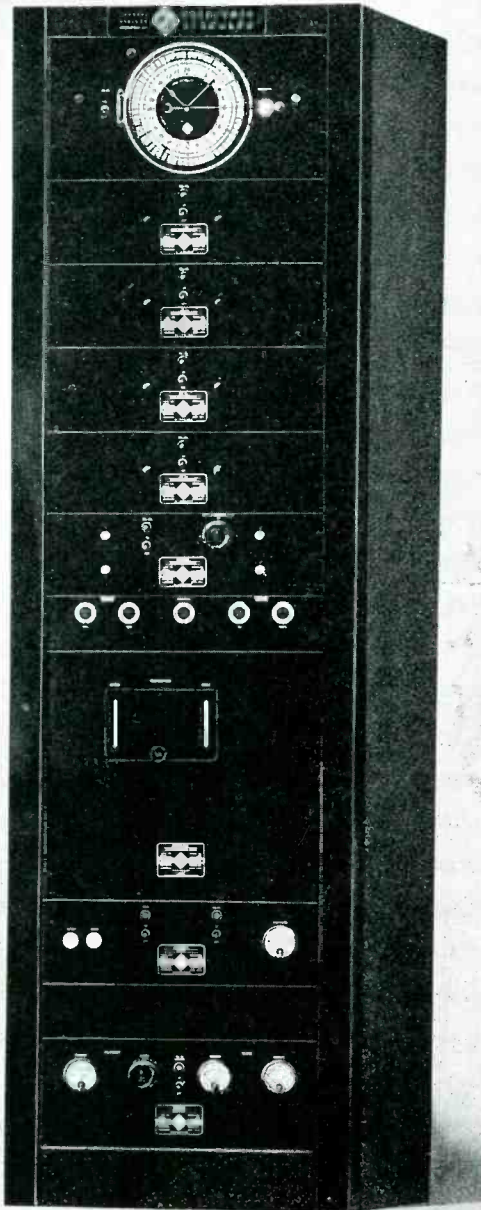

THIS IS THE FACE of the most accurate commercial clock in the world . . . the 1,000-cycle clock controlled by the General Radio Type C-21-HLD Primary Standard of Frequency. This clock is used to compare directly the accuracy of the primary standard with the generally available standard time intervals obtained from astronomical observations and transmitted at frequent intervals by U. S. Naval Radio Stations to all parts of the world.

From these time signals the user of the G-R Primary Standard of Frequency can conveniently and accurately check the operation of the frequency standard.

The G-R Standard, in its elements, consists of a 50-kc piezo-electric oscillator with very accurate temperature control; several frequency dividers controlled by the oscillator; the clock driven at 1,000 cycles; an oscillator control panel; an a-c power supply and a terminal board.

Although the standard is an extremely accurate time-keeper, its primary use is as a generator of radio and audio frequencies, which are known with considerable accuracy. With suitable auxiliary interpolation and measuring apparatus, the direct precision measurement of any frequency in the audio- or radio-frequency spectrum is possible.

A large number of G-R Primary Standards of Frequency have been sold to educational, commercial and governmental organizations throughout the world. These standards are accurate enough to be used in such delicate scientific experiments as the determination of the force of gravity, the speed of light and the time of flight of bullets where measurements of the highest accuracy are necessary.

In the General Radio laboratories the bench of each engineer is provided with terminals from which the worker may obtain frequencies from a central Primary Standard of Frequency. Use is made of this standard in the design, manufacture and calibration of many G-R instruments.

The G-R Primary Standard of Frequency is not a scientific tool demanding the constant attention of an engineer . . . it is a work-a-day instrument which runs for years with only slight attention, and it can be used for precise frequency measurements by unskilled technicians.

GENERAL RADIO COMPANY
CAMBRIDGE, MASSACHUSETTS
 Branches in New York and Los Angeles

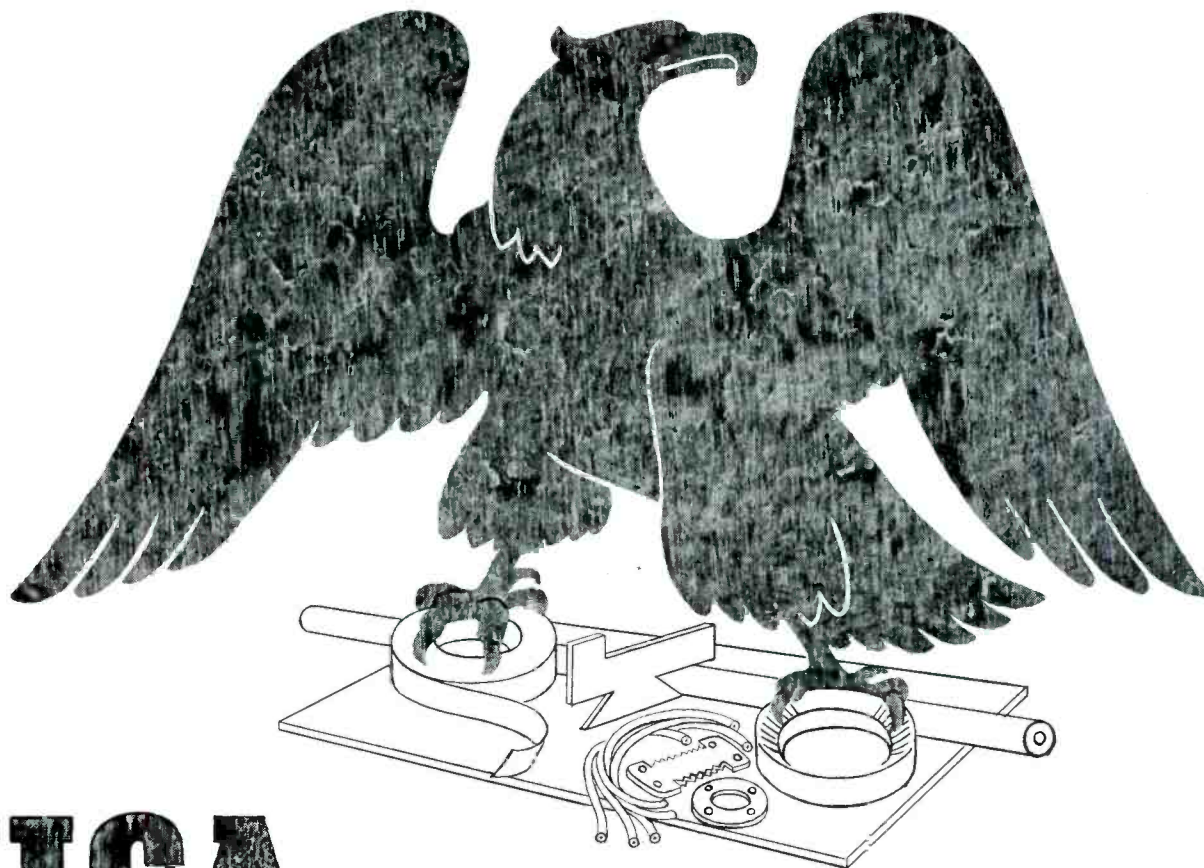

MICA *answers the call* *with many insulations!*



As America's new mechanized Army equipment rumbles off the production line, spark plugs and electrical equipment must be sturdy and trouble-free—so they are Mica-insulated.

In the air—delicate radio equipment must be unflinching as well as shielded from interference—with Lamicoïd. And at sea—great motors and generators must pack maximum power in minimum space—so they are insulated with Super-Micanite.



Mica is proud to play its part in furnishing these and a hundred more insulating accessories vital to the Preparedness Program. From actual fighting equipment

to the machine tools and other machinery that produce it, products of Mica Insulator Company are speeding up mechanization by serving an unending variety of electrical insulating requirements.



In most cases, these materials are being furnished to our regular customers. To help them meet today's new responsibilities, we have added to our productive facilities and gone on a full time schedule. In other words . . . doing everything possible to serve both old customers and new—promptly.

Mica Insulator Company's products include:—Micanite and Super Micanite Built-up Mica Insulations in sheets, tapes, rods, tubes and molded shapes; Lamicoïd laminated Bakelite for both electrical and mechanical applications; Empire Varnished Cloths, Tapes and Tubing; and a wide variety of other insulating materials.

MICANITE . . . SUPER MICANITE
EMPIRE VARNISHED INSULATION
LAMICOÏD LAMINATED PLASTICS

MICA INSULATOR COMPANY

200 Varick St., New York; 512 South Dearborn St., Chicago;
1276 West 3rd St., Cleveland; Birmingham, Boston, Cincinnati,
Los Angeles, San Francisco, Seattle, Montreal, Toronto

A RELIABLE SOURCE FOR ALL YOUR INSULATING MATERIALS

NOW YOU HAVE

18 Sources of Supply for

Phillips Recessed Head Screws



AMERICAN SCREW COMPANY
Providence, Rhode Island

CENTRAL SCREW COMPANY
Chicago, Illinois

CHANDLER PRODUCTS CORP.
Cleveland, Ohio

CONTINENTAL SCREW COMPANY
New Bedford, Massachusetts

THE CORBIN SCREW CORPORATION
New Britain, Connecticut

INTERNATIONAL SCREW COMPANY
Detroit, Michigan

THE LAMSON & SESSIONS COMPANY
Cleveland, Ohio

THE NATIONAL SCREW & MFG. CO.
Cleveland, Ohio

NEW ENGLAND SCREW COMPANY
Keene, New Hampshire

THE CHARLES PARKER COMPANY
Meriden, Connecticut

PARKER-KALON CORPORATION
New York, New York

PAWTUCKET SCREW COMPANY
Pawtucket, Rhode Island

PHEOLL MANUFACTURING COMPANY
Chicago, Illinois

RUSSELL, BURDSALL & WARD
BOLT & NUT COMPANY
Port Chester, New York

SCOVILL MANUFACTURING CO.
Waterbury, Connecticut

SHAKEPROOF LOCK WASHER CO.
Chicago, Illinois

THE SOUTHWINGTON HARDWARE CO.
Southington, Connecticut

WHITNEY SCREW CORPORATION
Nashua, New Hampshire

Your screw requirements can be met without delay!—with genuine fast-starting, quick-driving, tight-seating Phillips Recessed Head Screws.

WHAT ABOUT DRIVERS? There are 44 sources of supply for PHILLIPS DRIVERS plus general hardware and mill supply distribution.

PHILLIPS RECESSED HEAD SCREWS...

WOOD SCREWS • MACHINE SCREWS • SHEET METAL SCREWS • STOVE BOLTS
SPECIAL THREAD-CUTTING SCREWS • SCREWS WITH LOCK WASHERS

U. S. Patents on Product and Methods Nos. 2,046,343; 2,046,837; 2,046,839; 2,046,840; 2,082,085; 2,084,078; 2,084,079; 2,090,338. Other Domestic and Foreign Patents Allowed and Pending.

*Speed Product Deliveries by
Cutting Assembly Time*

PHILLIPS SCREWS COST LESS TO USE



ANNOUNCEMENT
EXTRAORDINARY!

DUAL 24 HOUR RECORDER **\$840⁰⁰**
FOR SIMULTANEOUS PLAYBACK

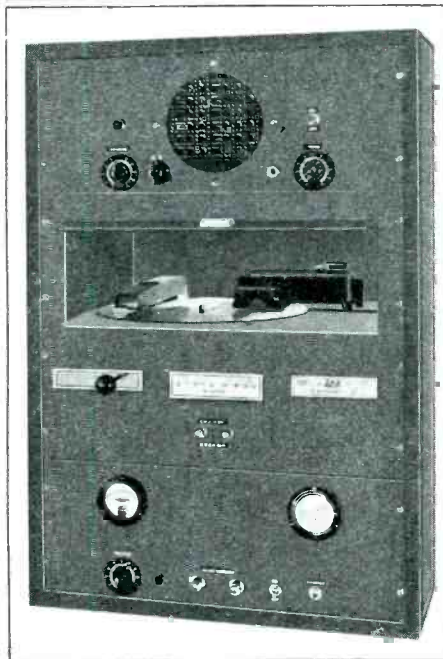

SINGLE SPOT RECORDER **\$540⁰⁰**
FOR INSTANTANEOUS PLAYBACK

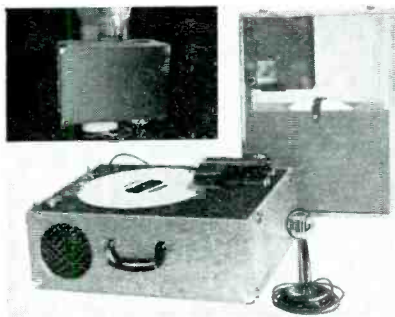

PORTABLE RECORDER **\$300⁰⁰**
FOR INSTANTANEOUS PLAYBACK

REFERENCE RECORDING
Costs Cut 2 ways!

for
CONVERSATIONS
CONFERENCES
COMMUNICATIONS
and
VOICE TRAINING

★ **HERE'S NEWS... Real News! NOW... life-like reference recordings... on paper-thin discs... suitable for filing like a letter... as simply and easily made as using a telephone or phonograph! Revolutionary new equipment costs approximately ONE-HALF! Operating costs as low as 10 CENTS PER HOUR! Sensational savings are now available to airlines, radio stations, schools, police departments and all commercial and industrial concerns. 5 MODELS... portable and stationary types... ready for immediate delivery. New Functional Assembly to meet your exact requirements. Write, wire or telephone for further information!**

**PAPER-THIN RECORDS
-FILE LIKE LETTERS!**

Special plastic material — flexible, tough, nearly indestructible! Unaffected by atmospheric temperature or moisture. Clean, easily handled. Not a fire hazard. Makes no shavings. One stylus serves indefinitely. Easily titled and filed for future reference and playback.

When writing, submit full details of your reference recording problem for complete engineering report. Address Department E-3





FRANK RIEBER, Inc.
Main Office and Factory
11916 WEST PICO BLVD.
LOS ANGELES, CALIF.



Licensed by Electrical Research Products, Inc. under Patents of American Telephone & Telegraph Co. and Western Electric Co. Inc.

DUAL Speaker JHP-51

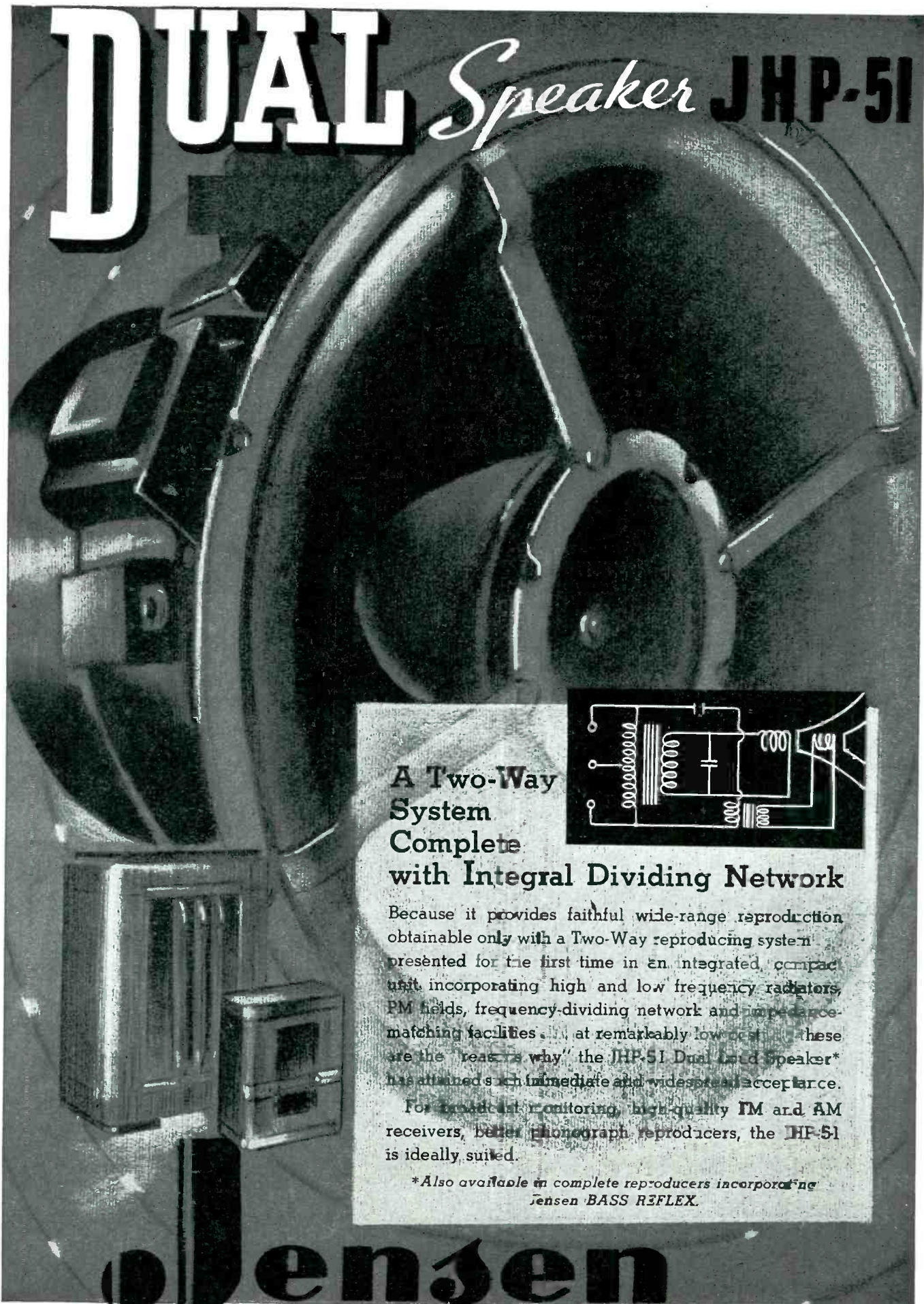

A Two-Way System Complete with Integral Dividing Network

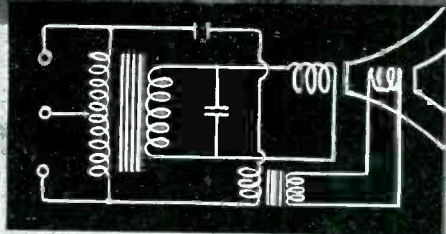

Because it provides faithful wide-range reproduction obtainable only with a Two-Way reproducing system presented for the first time in an integrated, compact unit incorporating high and low frequency radiators, PM fields, frequency-dividing network and impedance-matching facilities... at remarkably low cost... these are the reasons why the JHP-51 Dual Loud Speaker* has attained such immediate and widespread acceptance.

For broadcast monitoring, high-quality FM and AM receivers, better phonograph reproducers, the JHP-51 is ideally suited.

**Also available in complete reproducers incorporating Jensen BASS REFLEX.*

Jensen

RADIO MFG. CO., 6601 SOUTH LARAMIE AVENUE, CHICAGO



GAMMATRON

NOW IN ITS **13th** YEAR

Heintz and Kaufman made the first Tantalum tube 13 years ago. Now every major vacuum tube manufacturer has followed the lead of GAMMATRON. Because Heintz and Kaufman engineers pioneered Tantalum tubes, they are today's leaders in this field. For maximum performance, reliability and life go GAMMATRON today! Condensed characteristics are shown in the table below.

TUBE TYPE NO.	24	54	254	257	354A*	354C	354D	354E	354F	654	1054	1554	279-A 2054-A	3054
MAXIMUM POWER OUTPUT: Single Class Tube 'C' R.F.	89	210	450	230	700	750	700	700	700	1400	3000	4000	2000	5300
MAXIMUM POWER OUTPUT: Two Tubes Class 'B' Audio (2½% Harmonic Distortion)	125	200	450	...	630	650	690	690	725	1350	3500	4500	4000	7000
F.C.C. BROADCAST RATINGS: High Level Modulation Low Level Modulation Grid Modulation	...	50	100	...	250 50 50	250 50 50	250 50 ...	250 50 ...	250 50 ...	500 125 100	...	1000 250 250	750 500 ...	2500 500 500
NORMAL PLATE DIS.: Watts	25	50	100	75	150	150	150	150	150	300	750	1000	1000	1500
AVER. AMP. CONSTANT	25	27	25	...	9	14	22	35	50	22	13.5	14.5	10	20
MAXIMUM RATINGS: Plate Volts Plate M.A. Grid M.A.	2000 75 30	3000 150 30	4000 200 40	4000 150 25	4000 300 50	4000 300 50	4000 300 55	4000 300 60	4000 300 75	4000 600 100	6000 1000 125	6000 1300 250	3000 800 200	5000 2000 500
FILAMENT: Volts Amperes	6.3 3.0	5.0 5	5.0 7.5	5.0 7.5	5.0 10	5.0 10	5.0 10	5.0 10	5.0 10	7.5 15	7.5 22	11.0 22	10.0 22	14.9 45
MAXIMUM FREQUENCY: Full Ratings, Mc.	100	100	50	50	30	30	30	30	30	20	15	15	15	15
INTERELECTRODE CAP.: C g-p u.u.f. C g-f u.u.f. C p-f u.u.f.	1.7 2.5 0.4	1.9 1.9 0.2	3.4 3.3 1.1	0.04 13.8 6.7	4 9 1	4 9 1	4 9 1	4 9 1	4 9 1	5.5 6.2 1.5	4.5 6.0 .8	11 15.5 1.2	18 15 7	15 25 2.5
PHYSICAL: Length, inches Diameter, inches Base Weight, oz.	4¾ 1½ Small UX 1¼	5¾ 2 STD. UX 2½	7¼ 2½ 50 Watt 6½	6¾ 2½ GIANT 7 PIN	8¼ 3 50 Watt 9	8¼ 3 50 Watt 9	8¼ 3 50 Watt 9	8¼ 3 50 Watt 9	8¼ 3 50 Watt 9	10¾ 4 50 Watt 14	16½ 5 Special 45	18 6 HK255 56	21½ 6 W.E.Co. 66	30¾ 9 HK255 200
NET PRICE	\$3.50	\$6.75	\$12.50	\$22.00	\$24.50	\$24.50	\$24.50	\$24.50	\$24.50	\$75.00	\$175.00	\$225.00	\$300.00	\$395.00

*Type 354 is supplied in either high frequency style (grid terminal on side of envelope) or standard style (grid terminal on base).

WRITE FOR FULL DATA ON GAMMATRON
ENGINEERED TANTALUM TUBES.....



... In the Petroleum Industry
P. R. MALLORY & CO. INC.
MALLORY Cable Connectors
Play an Important Role
in Gun Perforators

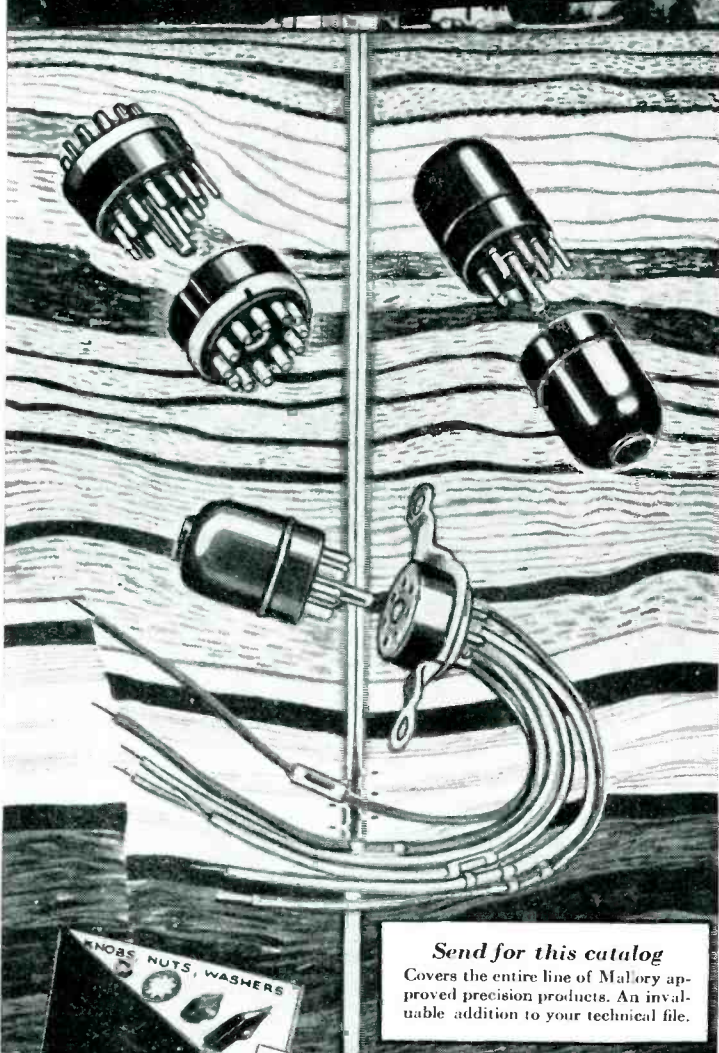

Send for this catalog
 Covers the entire line of Mallory approved precision products. An invaluable addition to your technical file.

WHEN you need a convenient means of making or separating multiple connections quickly and easily, be guided by the choice

of leading manufacturers in many fields who specify Mallory Cable Connectors. Prominent among these is the Lane-Wells Co., well known for their technical oil field services. In building their Gun Perforator . . . a device used to unleash new floods of "black gold" in hitherto abandoned oil wells . . . they chose a standard stock Mallory cable connecting device for maximum dependability.

Mallory Cable Connectors are available in both 7 wire and 12 wire types . . . with or without cables. Receptacles and plugs are polarized to prevent incorrect insertion. In fact, they represent to the highest degree, the advanced design and manufacturing care that characterizes all Mallory approved precision products.

P. R. MALLORY & CO., Inc.
INDIANAPOLIS INDIANA
 Cable Address—PELMALLO

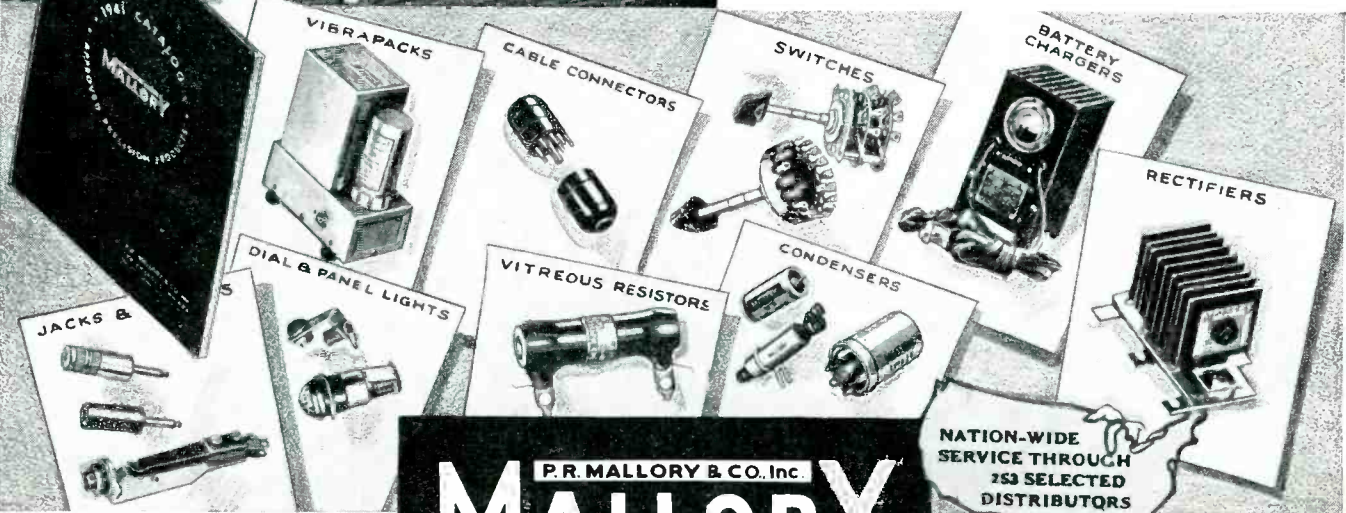



CROSS TALK

► TELEVISION VS DEFENSE . . .

Chairman Fly of the F.C.C., in summing up the situation regarding commercialization of television at the January 27th meeting with the N.T.S.C., mentioned the question of availability of men, materials and manufacturing facilities, for producing television equipment, pointing out that the radio industry has its hands full with defense production. It is clear that this problem is one of the few remaining obstacles to the full commercialization of the video art, since the standardization question has been dealt with so adequately by the N.T.S.C. It is a question which has bothered many industry executives who are trying to plan for the future.

Defense orders should, and must, come first in every plant in the industry. But this does not mean that commercial television is ruled out. Far from it. The industry still has reserve capacity to take on television, and there are several cogent reasons, in the national interest, why television should be encouraged. In the first place, while television itself is not viewed too highly as a military weapon in its present state, the by-products of video research, particularly wideband relay circuits, coaxial lines, and u-h-f transmission technique are of undoubted military value. The accelerated pace of television development following commercialization will surely result in improved tools for the Army and Navy.

In the second place, while television may grow fast when commercial broadcast licenses are issued, its growth at first will be slow enough so that production facilities will not be overtaxed. The industry is set to produce over 10 million radio sets this year; it is certainly in a position to produce 100,000 television sets, without serious dislocation, and this is an optimistic outlook for the first year. Television must be content to grow more slowly than it would if no defense emergency existed, but slow growth is vastly preferable to complete stagnation.

Finally, in the interest of sound planning of the national economy, it must be realized that eventually the present emergency will pass. When it does, new industries will be vitally necessary to take over the greatly increased manufacturing facilities which have grown up to supply defense orders. The auto industry took up much of the slack after the last world war. Television, having passed its growing pains, should be in an excellent position to expand rapidly once the world returns to a happier and more peaceful state. In the meantime, the industry must be willing to plan television's growth carefully and slowly, not to expect large volume or an extensive audience in the first months, waiting for the real opportunity later on. But if commercial television is not encouraged now, the opportunity may be lost for many years.

► WHO'S WHO . . . Radio fares rather badly in "Who's Who in America" according to Raymond Service, Inc., direct mail specialists who have made an occupational survey of this book of the elite. There are 975 editors, 440 newspaper writers, 361 publishers, 2,753 college professors, 2,775 lawyers, 2,586 clergymen, 1,929 authors—but only 42 radio men. There are more pathologists and more entymologists than radioists.

The Editors will be glad to receive anybody's guess at who these 42 men are—but please, no peeking at Raymond Service's list, before guessing!

► SKIN EFFECT . . . For many years the Bureau of Standards Bulletin 74, "Radio Instruments and Measurements" has been a bible in many engineers hands. Once at least this bulletin was reprinted privately appearing in smaller format and in a red cover. Both the first edition of the Bulletin, and the red reprint contains an error of interest to people working in high frequencies. Formulas and tables are provided showing how to compute the high-frequency resistance of cylindrical conductors (wires) in terms of the d-c resistance and as a function of frequency. One such formula reads $x = \pi d \sqrt{2\mu f / \rho}$, the x being fitted into a table to give the ratio of h-f to d-c resistance. This formula must be multiplied by the square root of 1000 to make it work.



● **The National Television System Committee**

... Photographed in the midst of deliberations on January 14th, when the members approved the 22 standards drawn up by the nine panels, and authorized their submission to the F.C.C. Seated, left to right: Daniel Harnett, Hazeltine Service Corporation; William MacDonald, Hazeltine, alternate; Adrian Murphy, C.B.S.; Dr. R. H. Manson, Stromberg-Carlson; E. W. Engstrom, Radio Corporation of America; Dr. A. N. Goldsmith, Institute of Radio Engineers; Paul Raibourn, Television Productions, Inc.; D. G. Fink, Electronics, Secretary of the Coordination and Editing Committee; L. C. F. Horle, Panel Coordinator and Acting Chairman of the Coordination and Editing Committee; W. R. G. Baker, General Electric Company, Chairman of the N.T.S.C.; Martha Morlock Kinzie, recording secretary; Allen B. DuMont, A. B. DuMont Laboratories; Dr. T. T. Goldsmith, Jr., DuMont, alternate; J. V. L. Hogan, National Association of Broadcasters; Seymour Turner, Television Productions, observer; Dr. E. F. W. Alexanderson, General Electric Company. Standing, left to right, D. B. Smith, Philco Corporation; J. E. Brown, Zenith, alternate; J. R. Howland, Zenith Radio Corporation; A. F. Murray, Hughes Tool Company, alternate; B. R. Cummings, Farnsworth Television and Radio Corporation; Dr. Ralph Bown, Bell Telephone Laboratories; and Dr. P. C. Goldmark, C.B.S., alternate

N.T.S.C. Proposes Television Standards

Twenty-two specific transmission standards, developed by the National Television System Committee and its nine panels, were presented for adoption by the F.C.C. at a meeting held January 27, Industry hopes for early commercialization after hearing to be held March 20th

FOR months, while commercial activity in television has been at a standstill, the industry has been waiting word of the deliberations of the National Television System Committee, appointed last summer to study the standards question and to make specific recommendations to the Federal Communications Commission. On January 27th the long awaited public announcement came, when the chairmen of the nine N.T.S.C. panels rendered reports before the F.C.C. at Washington. Chairman Fly of the Commission took occasion at the opening of the meeting to remark that the work of the N.T.S.C. was an outstanding accomplishment. Judged by any standard the Committee has performed a monumental research and in a remarkably short space of time.

Figures released by Chairman W. R. G. Baker indicate the scope of the work. The Committee was composed of 169 members, including alternates and the members of the nine panels which studied specific phases of the problem. These men attended 60 meetings within the space of slightly over four months, attended 20 laboratory demonstrations, and spent a total of over 5,000 man-hours on the work, not counting time spent traveling and in the preparation of reports. Over half a million sheets of paper were consumed in circulating minutes and reports to the N.T.S.C. membership.

On January 14th, the N.T.S.C. approved a group of 22 transmission standards which had previously been developed by the panels and edited by a coordination committee. At the Washington meeting these standards were presented individually to the F.C.C. by the panel chairmen responsible for their development. To observers at the meeting, the Commis-

sion seemed well impressed with the work, and indications were that the standards might be officially adopted, perhaps with minor modifications, in the near future. Prior to such action, however, a public hearing will be held on March 20 at which all interested parties may present evidence for or against the adoption of the standards.

Standards Similar to R.M.A. Recommendations

The N.T.S.C. proposed standards bear a very close similarity to the standards drawn up two years ago by the television committee of the Radio Manufacturers Association. The only major difference between the two sets of standards, in fact, is the recommendation that frequency modulation be used for the sound transmissions, with a maximum deviation of 75 kc. The resemblance between the two groups of standards does not mean, however, that the N.T.S.C. merely endorsed the R.M.A. recommendations without an intensive investigation of their merits. The reports and minutes of discussion which preceded the Committee's action number 2000 mimeographed pages, and make a stack of nine bound volumes measuring in all nearly eight inches thick. The study is manifestly the most exhaustive investigation ever carried out in the field. For this reason it may fairly be said that whereas there was some doubt as to the validity of the R.M.A. standards there is now very little doubt as to the validity of the N.T.S.C. standards.

Previous to the meeting in Washington, members of the F.C.C. came to New York, on January 24th and 25th, to witness demonstrations of the latest television techniques as demonstrated by the staffs of the

DuMont Laboratories, the National Broadcasting Company and RCA Manufacturing Company, the Columbia Broadcasting System, the Bell Laboratories and the Scophony Company. A description of these demonstrations appears at the conclusion of this report.

As outlined in a previous article in *ELECTRONICS* (August 1940, page 34) the main body of the investigation was carried out by nine subcommittees or panels each charged with specific problems. The Chairman of each panel, in appearing before the F.C.C., explained the reasoning behind each standard and answered specific questions from the Commissioners and the Engineering Staff of the F.C.C. The standards are printed in the accompanying tabulation. What follows is a brief report of the Washington meeting.

Chairman Fly Outlines Purpose of Meeting

In opening the meeting on January 27th, Chairman Fly pointed out that the purpose was to ascertain the status of television development and to receive a progress report from the N.T.S.C. No cross-examination of those testifying was permitted, and the question of standardization and commercialization, per se, were not considered. Rather, the efficiency of the standards arrived at by the Committee was discussed. At a further hearing, all interested parties were assured of the opportunity to present their views.

Dr. W. R. G. Baker, Chairman of the N.T.S.C. then outlined the purpose and organization of the Committee and called upon Dr. A. N. Goldsmith, the Chairman of Panel 2, to present the report of that group. Panel 2 was charged with examining the subjective aspects of television

Proposed N.T.S.C. Television Standards

I. THE TELEVISION CHANNEL

1. The width of the standard television broadcast channel shall be six megacycles per second.
2. It shall be standard to locate the picture carrier 4.5 megacycles per second lower in frequency than the unmodulated sound carrier.
3. It shall be standard to locate the unmodulated sound carrier 0.25 megacycles per second lower than the upper frequency limit of the channel.
4. The standard picture transmission amplitude characteristic shall be that shown in Drawing I.

II. SCANNING SPECIFICATIONS

5. The standard number of scanning lines per frame period in monochrome shall be 441, interlaced two to one.
6. The standard frame frequency shall be 30 per second and the standard field frequency shall be 60 per second in monochrome.
7. The standard aspect ratio of the transmitted television picture shall be 4 units horizontally to 3 units vertically.
8. It shall be standard, during the active scanning intervals, to scan the scene from left to right horizontally and from top to bottom vertically, at uniform velocities.

III. PICTURE SIGNAL MODULATION

9. It shall be standard in television transmission to use amplitude modulation for both picture and synchronizing signals, the two signals occupying different amplitude ranges.
10. It shall be standard that a decrease in initial light intensity cause an increase in radiated power.
11. It shall be standard that the black level be represented by a definite carrier level, independent of light and shade in the picture.
12. It shall be standard to transmit the black level at 75 per cent (with a tolerance of plus or minus 2.5 per cent) of the peak carrier amplitude.

IV. SOUND SIGNAL MODULATION

13. It shall be standard to use frequency modulation for the television sound transmission.
14. It shall be standard to pre-emphasize the sound transmission in accordance with the impedance-frequency characteristic of a series inductance-resistance network having a time constant of 100 microseconds.

V. SYNCHRONIZING SIGNALS

15. It shall be standard in television transmission to radiate the synchronizing waveform shown in Drawing II.
16. It shall be standard that the time interval between the leading edges of successive horizontal pulses shall vary less than one half of one per cent of the average interval.
17. It shall be standard in television studio transmission that the rate of change of the frequency of recurrence of the leading edges of the horizontal synchronizing signals be not greater than 0.15 per cent per second, the frequency to be determined by an averaging process carried out over a period of not less than 20, nor more than 100, lines, such lines not to include any portion of the vertical blanking signal. (See Note A).

VI. TRANSMITTER RATINGS

18. It shall be standard to rate the picture transmitter in terms of its peak power when transmitting a standard television signal.
19. It shall be standard in the modulation of the picture transmitter that the radio frequency signal amplitude be 15 per cent or less of the peak amplitude, for maximum white. (See Note B).
20. It shall be standard to employ an unmodulated radiated carrier power of the sound transmission not less than 50% nor more than 100% of the peak radiated power of the picture transmission.
21. It shall be standard in the modulation of the sound transmitter that the maximum deviation shall be plus or minus 75 kilocycles per second.

VII. POLARIZATION

22. It shall be standard in television broadcasting to radiate horizontally polarized waves.

NOTE A: It is recommended that as progress in the art makes it desirable, the maximum rate of change of frequency of the transmitted horizontal synchronizing signals for studio programs be reduced and that limits be set for transmissions originating elsewhere than in the studio.

NOTE B: It is the opinion of the N.T.S.C. that a picture transmitter not capable of a drop in radio frequency signal amplitude to 15 per cent or less of the peak amplitude would be unsatisfactory since it would not utilize to the best advantage the available radio frequency power. At the same time the N.T.S.C. is aware of the practical situation that it may not be possible for all of the first picture transmitters to meet this standard. It should be possible in picture transmitters for the lower frequency channels in Group A to meet this standard, although it may not be possible for picture transmitters for the higher frequency channels in Group A to meet it at first. After the first operation on the higher frequency channels and as designs progress it should be possible to meet it. It is requested that the Federal Communications Commission take cognizance of this situation.

As such it did not recommend any specific standards, nor did it consider the economic or technical matters which determine the relative desirability of alternative standards. Rather this group concerned itself with the effects of different types of picture on the eye and mind of the observer. In general Dr. Goldsmith reported that all the specific standards recommended by other panels fell within the limits specified by the members of his panel as being desirable and feasible. Upon questioning by the Commission, however, Dr. Goldsmith remarked that the recommended number of lines per picture, 441, was near the lower limit, and that an increase in the number of lines above this value might be in line with the opinion of the members of his panel. Regarding the number of frames per second, 30, he remarked that this figure was perfectly adequate but that a figure below 20 per second would probably be inadequate except under certain specified conditions. Dr. Goldsmith, in response to questioning on color television remarked that the radio audience today is blind, but that when black and white television becomes a reality the audience will be merely color-blind, and that eventually full vision, in the form of color television, should be available.

Dr. P. C. Goldmark, chairman of Panel 1, charged with the analysis of American and foreign television systems, then took the stand. This panel made a comprehensive list of some 31 television systems with all their scanning and transmission specifications. The panel also prepared an outline for the analysis of systems, giving the controlling advantages and disadvantages concerning each aspect of standardization. Concerning flexibility the panel recommended, for black and white transmissions, a single number of lines per picture and a single number of frames per second, i.e. the panel recommended against flexibility in these values. Concerning color television the panel was of the opinion that color systems were not yet ready for commercial standards but took cognizance of the proposal of C.B.S. to field test their color system with 343 lines per picture and 60 frames per second. The panel recommended also that such field tests be permitted on commercial

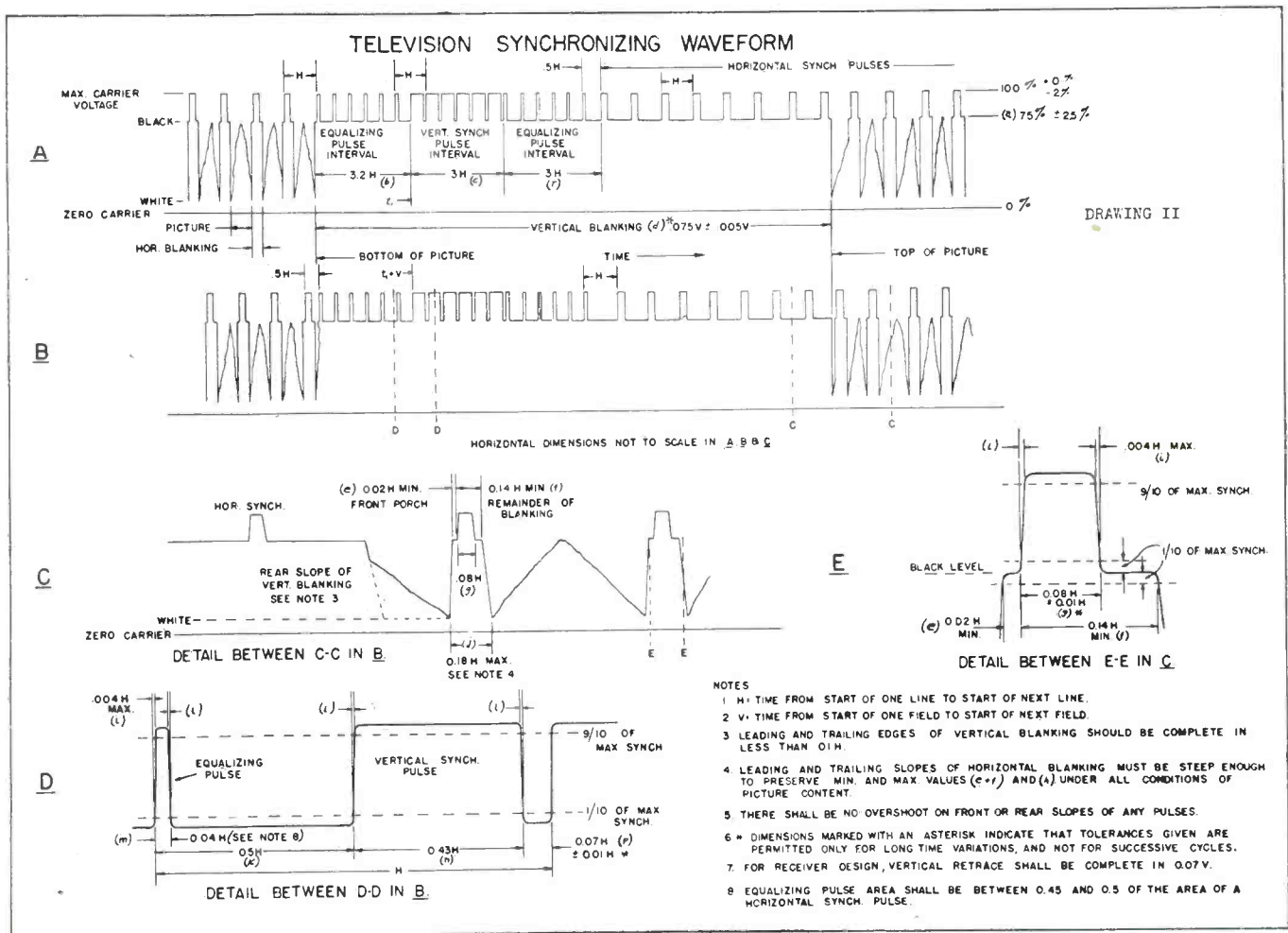

Drawing II: The N.T.S.C. Synchronizing Signal Waveform. This waveform is substantially the same as the R.M.A., except that the black level is at 75 per cent, plus or minus 2.5 per cent (R.M.A., 75 to 80 per cent), and the level for maximum white is 15 per cent of peak, or less (R.M.A., 25 per cent or less)

channels during hours not occupied with commercial broadcasting, provided that each such broadcast is identified as experimental. The panel recommended that after standards are adopted by the F.C.C., at least two years public notice be given of any impending changes.

J. E. Brown, Chairman of Panel 3 then offered the first four standards, dealing with the television channel (6 Mc wide, 4.5 Mc separation between sight and sound carriers, sound carrier 0.25 Mc from the upper edge of channel, and amplitude characteristic as shown in Drawing I). These standards are identical in all respects to the R.M.A. standards but Mr. Brown pointed out that each item had been developed entirely from a fresh consideration of the problem, the coincidence between the two recommendations being merely confirmation that the values recommended were the correct values.

B. R. Cummings, Chairman of Panel 5 then presented standards 10,

11, 13 and 21 (negative modulation, d-c transmission, frequency modulation for sound, 75 kc maximum deviation). The first two are identical to the R.M.A. standards but the remaining two represent a distinct departure, and result from the recent disclosures of the advantages of wideband fm for u-h-f sound broadcasting.

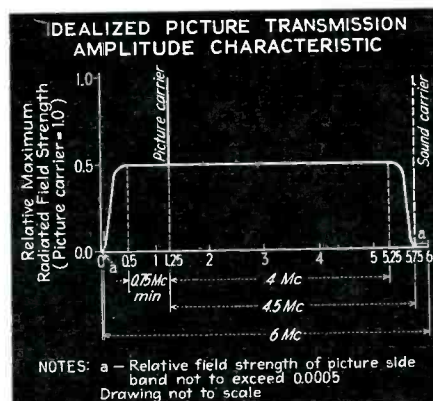

Drawing I: The transmission amplitude characteristic recommended by the N.T.S.C., identical to the R.M.A. proposed standard

I. J. Kaar, chairman of Panel 6, then presented standards 4, 13, 14, and 21 (Drawing I, fm for sound, audio pre-emphasis, and 75 kc maximum deviation). These standards, two of which overlapped the work of panel 5, were those requiring close coordination between receiver and transmitter. Mr. Kaar also presented an informal recommendation that the transmission characteristic relating the picture brightness to the percentage modulation be substantially logarithmic, in order to obtain an advantage in signal-to-noise ratio, although no standard on this subject was written.

The report of Panel 4 was then offered by E. W. Engstrom, who presented standards 18, 19, and 20 (transmitter rated by peak power, modulation of the picture transmitter for maximum white to be 15 per cent of peak or less, and the sound carrier power to be from 50 to 100 per cent of peak picture carrier power). On questioning by the Commissioners, Mr. Engstrom stated

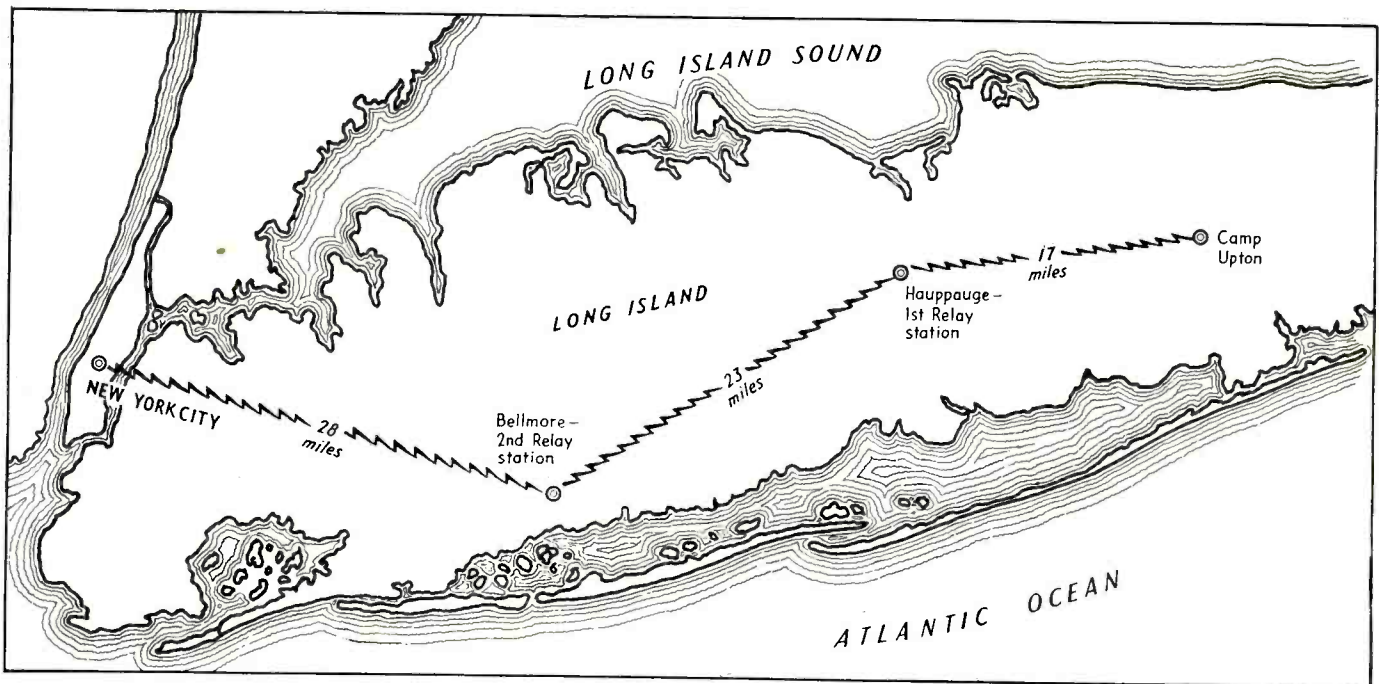

Transmission path of the R.C.A. television radio-relay demonstration. In addition to transmissions over the route shown, images from the Empire State were received at Camp Upton and relayed back to New York, over a transmission path totalling about 130 miles. The results were shown on a 15- by 20-foot screen in a New York theater

that these standards, as well as the others proposed, would permit the use of narrow-band fm for the picture transmission, without change in existing receivers, should this prove desirable at a later time. Chairman Fly requested information on R.C.A.'s experiments with color television, and was told that some of this work was similar to that of C.B.S., so far as the number of lines and frames per second were concerned.

Daniel Harnett, Chairman of Panel 7, then reported on the scanning standards, numbers 5, 6, 7, and 8 (441 lines, two-to-one interlace; 30 frames per second, 60 fields per second; 4-to-3 aspect ratio; and left-right, top-bottom scanning directions). The Commissioners were obviously somewhat surprised that the recommended number of lines was not higher than 441, and pointed out that the considerations of panel 2, as well as privately expressed opinions of many engineers, seemed to indicate that the desirable number of lines was in the vicinity of 500. The action of the panel was taken, Mr. Harnett reported, in view of many practical factors, particularly the fact that the lower number of lines favored the performance of the cheaper receivers which would probably constitute the bulk of the public investment in television, as well as the fact that reflections degrade the horizontal detail of the image,

which would be further reduced if a higher number of lines were chosen. The opinion that 30 frames, 60 fields per second were the correct values was shared by all but one member of the panel.

D. B. Smith, Chairman of Panel 9, reported on the 22nd standard (horizontal polarization). The Commissioners, remembering the strong stand taken by Philco for vertical polarization in earlier hearings, asked whether this company (Mr. Smith's employer) had changed its opinion. Mr. Smith reported that further field tests made by Philco and RCA had convinced him that either direction of polarization was equally suitable, but that the panel members had held a slight preference for horizontal. Mr. Smith felt that it was highly desirable, however, that the same direction of polarization be standardized for television and f-m sound broadcasting, so that a single receiving antenna would serve for both.

The last panel to report, Panel 8, headed by Dr. T. T. Goldsmith, Jr., offered standards 9, 15, 16, and 17 (amplitude modulation for picture and sync signals, sync waveform as in Drawing II, time variation of horizontal pulses less than 0.5 per cent, rate of change of horizontal frequency less than 0.15 per cent). It was obvious that the degree of agreement between panel members on this subject was less than on

other topics. Dr. Goldsmith stated that the N.T.S.C. pulse was substantially the same as the older R.M.A. pulse, and that it has an admitted deficiency due to the intrusion of low frequency energy on the high frequency pulses. The DuMont pulse, also considered by the panel, had a similar deficiency in the reduced amplitude of the horizontal pulses during the frame pulse. The opinion of the panel was that the first deficiency constituted the better choice. Later experiments by the Philco Corporation using the Hazeltine type of frequency-modulated sync pulse were described, and it was apparent that considerable support of this type of operation had grown up since the N.T.S.C. adopted the amplitude modulation standard.

At the conclusion of the meeting, Chairman Fly thanked the committee for its work and time and proposed that the work of the N.T.S.C. be carried forward by the industry, perhaps in the established standardization bodies of the R.M.A. He then posed four problems which seemed to be outstanding at present. The first was that of color television. Mr. Fly believes that the industry should decide which of the current proposals has the most merit and then to make an exhaustive investigation of its capabilities and limitations, the whole industry participating in this work rather than one company. Secondly Mr. Fly alluded

to the uncertainty regarding the proper method of transmitting the sync pulses, and declared the hope that experiments now under way would prove conclusive before the forthcoming hearing on commercial standards. Finally, while stating that the F.C.C. had no jurisdiction over receiver manufacturers, he hoped that the industry would find it advisable to build receivers to make the fullest possible advantage of the signals transmitted, and to guard as much as possible against obsolescence. As a fourth point, Mr. Fly mentioned the problem of maintaining adequate supplies of time, men, materials, and manufacturing facilities for launching commercial television, in view of the large volume of defense activity now under way in the radio industry. He did not state that this was an insuperable problem, but merely that it was a factor to be taken into account in further deliberations.—D.G.F.

F.C.C. Views Demonstrations

When the complete development of television is narrated, historians are likely to select the dates of January 24 and 25, 1941 as marking the end of one important step of progress. On these days, members of the F.C.C., the N.T.S.C., and the press inspected the latest improvements of television systems in the vicinity of New York developed by the organizations who are recognized leaders in television progress. The television systems of the Allen B. DuMont Laboratories, the Radio Corporation of America, the Bell Telephone Laboratories, the Columbia Broadcasting System, and Scophony Television, were put through their paces in an effort to demonstrate that television is sufficiently developed and advanced in technical quality, as well as in good showmanship and entertainment value, to warrant the licensing of commercial stations and the inauguration of commercial television programs.

It is certainly safe to say that there has never before been such an array of modern, high quality television systems and programs displayed in so short a time to as distinguished a group. One expected to see the usual type of television receiver, with the modifications and refinements which have been recently completed in the research labora-

tories, and these were shown. But in addition there were projected images on screens 3x4 feet, 9x12 feet and even 15x20 feet in size; there was three-color television on a screen about 8x10 inches; there were demonstrations of the effect on detail and definition of decreasing the video band width to 2.75 Mc; film, live studio, and remote pick-up programs were shown; and programs were transmitted over radio and cable circuits for distances of from approximately 50 feet to nearly 200 miles. In the transmissions by radio automatic relay stations were utilized. There was excellent—and some mediocre—program technique displayed in the pictures which, in definition and detail compared favorably with 16-mm black and white film (or in the case of color television, with Kodachrome) or with news reels made by professional camera men under the same circumstances for which the television pictures were picked up.

The first plunge in this two-day demonstration was made by the Allen B. DuMont Laboratories where members of the F.C.C. and N.T.S.C. gathered at W2XWV, 515 Madison Ave., New York to witness the DuMont system utilizing images transmitted at 15 frames per second with vertical resolution corresponding to 625 lines. As a preliminary demonstration to show that flicker is not objectionable at the relatively low frame frequency of 15 frames per second, 16-mm motion pictures, in color as well as in black and white, were exhibited. With respect to flicker and "frame jump" these pictures are almost exactly comparable with the pre-sound movies, ante-dating 1927, when the picture frequency was 16 frames per second.

As part of its television demonstration the DuMont organization showed two of their standard model receivers. One of these used a tube with a 14-inch screen to produce an image about 8x10 inches while the larger receiver showed 11x16 inch pictures produced through the use of a 20-inch tube. Both tubes utilized a white screen of reasonably long persistence. In both receivers 625-line images with 15 frames per second were shown. Driven synchronization was employed in which the transmitted synchronizing signals control directly the operation of

the image producing tube. (See *ELECTRONICS*, March 1938 for description of fundamental mode of operation of this system.) Live pick-up was used as Dr. T. T. Goldsmith, Jr., outlined the contributions to television which the DuMont laboratories have made during the past year.

It was the purpose of the DuMont Laboratories to demonstrate that:

(1) The use of cathode ray tube screens of the "memory" or long persistence type permit reduction of the picture repetition frequency from 30 to 15 frames per second without objectionable flicker.

(2) The reduction of width of the required frequency channel through the use of a lower frame repetition frequency for images of identical detail or conversely, increased detail for a frequency channel of specified width by increasing the number of lines from 441 to 625.

(3) Large pictures, such as the 11x16-inch images obtainable with the 20-inch tube were much more desirable than the usual 5x7 or 8x10-inch images obtainable with the 9-inch or the 14-inch tubes, respectively.

The two demonstrations given by the Radio Corporation of America provided an opportunity to become familiar with modern television showmanship methods and entertainment as well as with the most recent technical advances. The morning demonstration, on the 67th floor of the RCA Building, was given over to the showing of studio and remote pick-up programs on a new design of receiver producing images 13½x18 inches on a plane, translucent screen which slides into the front of the receiver when not required for telecasts. These receivers use a newly developed projection tube in a vertical position, which projects the image through a lens system onto a 45 degree mirror in the cover of the receiver. From the mirror the image is reflected onto the vertical translucent screen which may be easily viewed simultaneously by several score of persons. The pictures were black and white, with definition and detail comparable to that of 16-mm motion pictures.

In spite of inclement weather, scenes from Camp Upton, L. I., were shown as part of the demonstration. The mobile television pick-up unit

(Continued on page 60)

I.R.E. in New York . . . 1941

Television and new developments in electron multiplier tubes were spotlighted in the technical program of the sixteenth annual convention of the Institute of Radio Engineers. The banquet program was broadcast on a nationwide radio network and also to South America via short-wave stations. A. N. Goldsmith awarded Institute Medal

TELEVISION and new developments in tubes, especially the application of electron multipliers to tubes, were the subjects of greatest interest at the Sixteenth Annual Convention of the Institute of Radio Engineers in New York on January 9, 10, and 11. More than 1,300 engineers gathered at the convention to hear a well rounded program of 31 papers delivered by representatives of 11 organizations. The subjects of representative papers were the electron microscope, telegrams transmitted by facsimile, echoes in short-wave reception, radio-noise-meter performance, resistance tuning, signal-to-noise relations in high-transconductance tubes, small B-batteries, magnetic recording, and a new circuit for power generation at ultrahigh-frequencies as well as television and the electron multipliers.

In addition to the papers there were several interesting demonstrations. Columbia Broadcasting System showed its color television system making use of live pickup. The equipment used was briefly described in *ELECTRONICS* in December 1940 (page 27). The subject matter was much the same as was employed in the demonstration some time ago

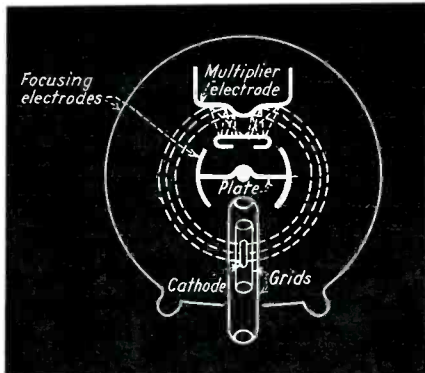

Cross-section of the orbital beam multiplier tube described by H. M. Wagner and W. R. Ferris

in which Kodachrome film was used. The light intensity in the studio was of the order of 200 foot-candles which is about the same order of intensity as is used for monochrome television. Results were comparable to the Kodachrome demonstration. Bell Telephone Laboratories also demonstrated their television system using a 200-mile loop of coaxial cable between New York and Philadelphia. The results were very impressive when the picture was switched from the local circuit to the 200-mile loop. The change in quality of the picture was so small that it took a sharp eye to detect the

difference, although when a test pattern was used the change in definition was easily seen.

A highlight of the program was the banquet held on Friday evening at which Gano Dunn, president of the J. G. White Engineering Corp. and consultant to the National Defense Commission, was the guest of honor and delivered the address of the evening. The radio engineering profession received a great deal more than its usual publicity because of the diligent efforts of the program committee and excellent cooperation of the broadcasting companies. Mr. Dunn's address was broadcast over the nation-wide network of the Mutual Broadcasting System, and to South America over the short-wave stations of National Broadcasting Co., Columbia Broadcasting System, and Mutual. Adolpho T. Cosentino, newly elected vice-president of the Institute and a well known radio engineer of Argentina, speaking in Buenos Aires, addressed the audience in New York over the facilities of the International Telephone and Telegraph Co. as well as those of the above mentioned broadcasting companies. Also, the dinner music was furnished by Mutual and was broadcast over f-m station W2XOR.

Mr. Dunn, in his address, enumerated the many accomplishments of the radio engineer in tying the world together with instant communication facilities, in providing stricken steamships with a means of salvation, in giving an almost universal entertainment and educational medium, and in applying the principles of radio to many industrial and commercial uses. He also stressed that radio is inherently international in its numerous aspects, because the effects of radio activities cannot be confined to the boundaries of a single country.

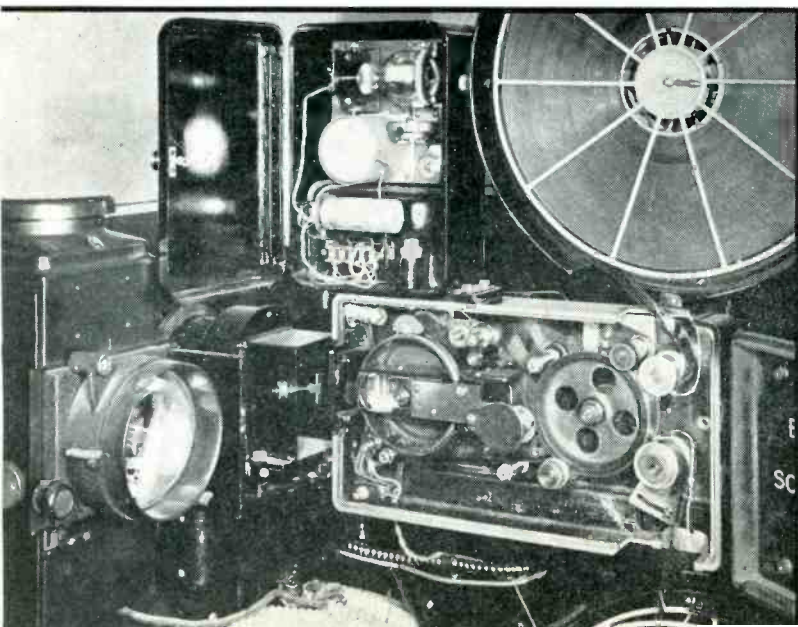

Film scanner for television in which every other frame of standard film is printed three times and the rest twice to give a 60-frame film (A. Jensen)

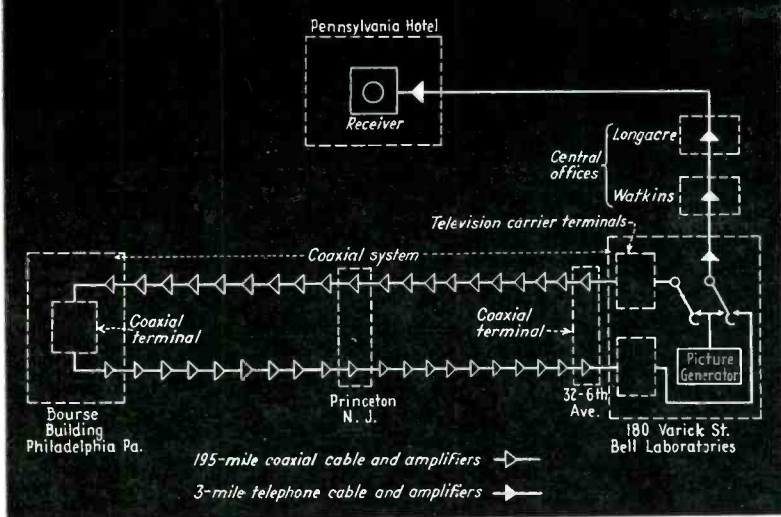

Block diagram of the 200-mile coaxial cable loop between New York and Philadelphia which was used in the television demonstration by Bell Laboratories

Dr. A. N. Goldsmith, consulting engineer and one of the founders of the I.R.E., was awarded the Institute's Medal of Honor for his many contributions to radio's progress.

At the opening session of the technical program, L. C. F. Horle, retiring president, introduced Frederick E. Terman, president of the Institute for the coming year. Dr. Terman then presided over the session and introduced the first speaker, J. Hillier, who presented "Recent Developments in the RCA Electron Microscope" prepared by himself and A. W. Vance, both of RCA Manufacturing Co.

One of the most important problems in the design of an electron microscope is the maintenance of constant voltages and currents so that the image will remain in proper focus on the fluorescent screen. The voltages and currents in the instrument described are held to within 2 parts in 100,000 or 0.002 per cent of the specified value. Photographs were shown of different substances magnified to such a degree that particles of the order of 4 or 5 times molecular size were easily discernible. An application where the use of the electron microscope proved commercially profitable was described. It was found by use of the microscope that if the particle size of lead arsenate used in insecticides was reduced to a fraction of the

previous size, its potency was increased to such an extent that only 20 per cent of the normal amount had to be used. Thus, a very considerable saving in the preparation of the insecticide was effected.

Telegrams in Facsimile

"The Handling of Telegrams in Facsimile" was presented by R. J. Wise and I. S. Coggeshall of the Western Union Telegraph Co. The equipment used for transmission of the telegrams is very similar to that for transmitting photographs by wire. It consists of a metal cylinder $7\frac{1}{2}$ inches in circumference around which the copy is wrapped. As the cylinder rotates at a speed of 180 rpm the telegram is scanned by a scanning head which contains a light source and a phototube. The scanning pitch is 100 lines per inch to give a scanning distance of 1,400 inches per minute and a scanned area of 14 square inches per minute. To compensate for the color of the paper on which the copy is written a balancing lamp and phototube are used. The receiving equipment is very similar except that a means of making electrical contact with the surface of the paper is used instead of photoelectric scanning. The paper is built up of a paper layer on bottom, a layer of carbon in the center and a thin coating of insulating material on top. As contact is made, the

top layer is removed exposing the black carbon underneath. Contact is made with the paper at the rate of 10,000 impulses per second to give good definition to the message. It is believed that the cost of transmitting telegrams by facsimile will very likely be lower than the cost of the present method.

K. G. Jansky and C. F. Edwards, of the Bell Telephone Laboratories, presented "Measurements of the Delay and Direction of Arrival of Echoes from Near-by Short-Wave Transmitters." Such echoes fall into three general classes: multiple, random and sharp echoes. The most persistent of these is the multiple echo and the discussion was concerned with this type. Most of the tests described were on the Lawrenceville, N. J., to London beam with the measurements made at Holmdel, N. J. It was concluded from the data presented that the multiple echoes resulted from a scattering of the signal at the surface of the earth. It was also shown that the same general type of echo resulted from short-wave stations located further away as long as the observer is in the skip zone.

Television

M. E. Strieby and C. L. Weis, of Bell Telephone Laboratories, delivered a paper entitled "Some Factors Affecting Television Transmission".

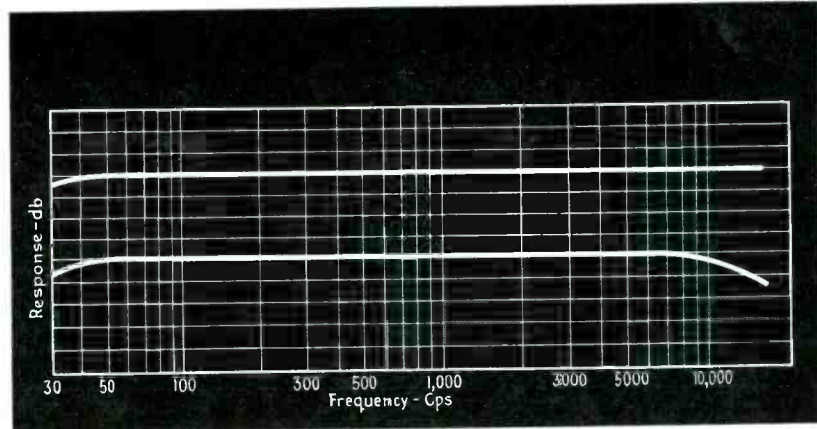

Frequency characteristic of the program-operated level-governing amplifier described in the paper delivered by W. L. Black and N. C. Norman

Method of testing a coaxial transmission line when the opposite end is unavailable for connection (M. E. Strieby and C. L. Weis)

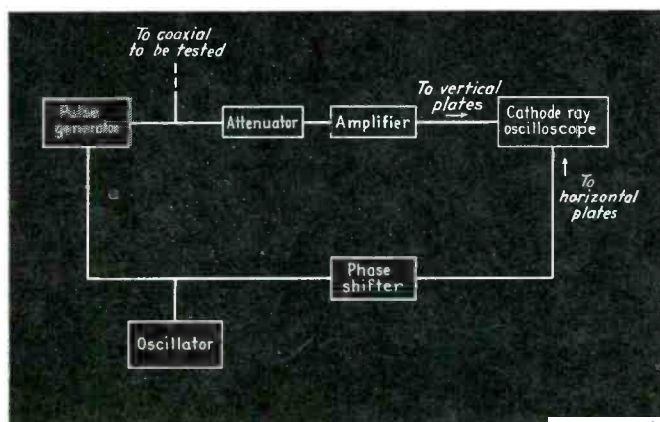

Frequency deviation-voltage characteristic of the General Electric 50-kw f-m transmitter (H. P. Thomas and R. H. Williamson)

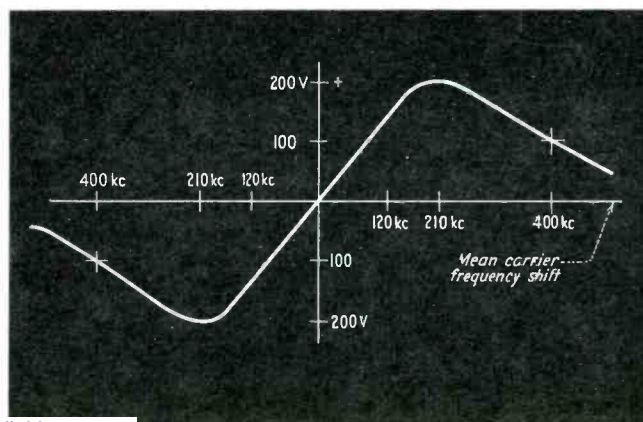

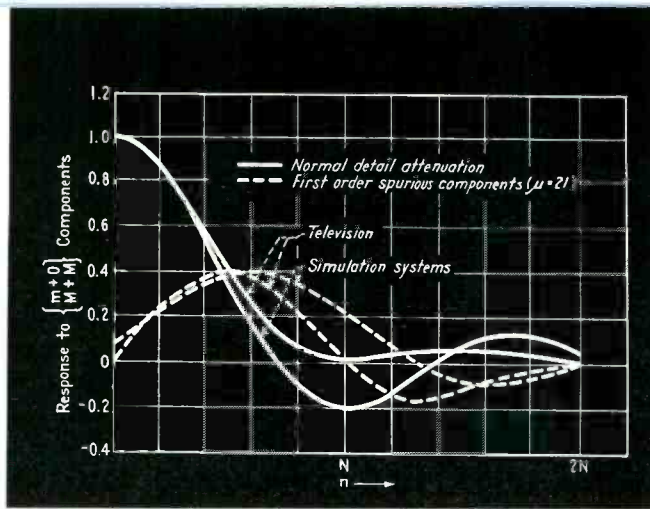

Curves showing comparison between normal television signals and signals over a simulation system described by R. E. Graham and F. W. Reynolds

They were primarily concerned with transmission over the coaxial cable loop between New York and Philadelphia which is 200 miles in length. The various types of distortion and interference were discussed. The effects of the different types were shown with photographs of the screen of a particular picture tube whose characteristics were described. Several slides were shown which illustrated the effects of multiple images, echoes, phase distortion or delay distortion. A demonstration of television using the New York-Philadelphia loop was given and the effects of the use of the cable were pointed out. The differences were so slight that an experienced eye was necessary to find them on motion picture transmission.

Axel G. Jensen of Bell Telephone Laboratories described a "Film Scanner for Use in Television Transmission Tests" which is intended primarily for use as a tool in designing television circuits. One of the more important problems of scanning motion picture film is that 24-frame film must be translated into a 30-frame television picture. This was solved by stretching the film by printing every other frame twice and the remainder three times in succession to give a 60-frame picture instead of the original 24. Vertical scanning is then obtained by the continuous motion of the film and

horizontal scanning is obtained by a simple electronic line sweep in the pickup tube (Farnsworth image dissector). This results in a rather simple mechanical construction and permits the use of an efficient optical projection system for projecting the moving film on to the dissector cathode.

"A Coaxial Filter for Vestigial-Sideband Transmission in Television" was described by H. Salinger, of Farnsworth Television and Radio Corp. A ladder type experimental filter was built for the 66 to 72 Mc television channel. The attenuation at 66 Mc was 32 db for each per cent of change in frequency. The main difficulties of design were largely geometrical and the method of attacking the problem of designing a very compact filter structure was outlined. The performance characteristics of the unit were also discussed.

D. E. Norgaard and J. L. Jones, of General Electric Co., described the apparatus necessary in a well equipped control room for the production of modern high-definition television programs. The arrangement of the various pieces of equipment is such that the activities of several operators are easily coordinated and to provide for future expansion without disturbing the apparatus already installed. The important features of a number of

components were described. Television control room equipment for commercial use were also described by J. Schantz and W. Ludwick, of Farnsworth Television and Radio Corp.

A. L. Nelson, of Farnsworth Television and Radio Corp., described a method for the efficient production of power at ultrahigh frequencies. The method makes use of conventional tubes in a series of frequency multiplying circuits in which the efficiency depends in large part on the phase relationships in the various circuits.

A paper on "Brightness Distortion in Television" was presented by D. G. Fink, managing editor of *ELECTRONICS*. Brightness distortion was defined as a lack of proportionality between the scale of brightness in the subject televised, and the corresponding scale of brightness in the received image. It was stated that lack of control of such distortion was one of the principal defects of present television systems, and that improvement in this respect could be made without recourse to a change in the transmission standards. By plotting the curve relating image brightness with object brightness on log-log coordinate paper, the visual effect of the brightness distortion was made apparent. Curvature of these log-log plots was termed "contrast distortion". Various forms of contrast distortion which are detrimental to the appearance of the image were described. A means of correcting the defect was suggested, employing the internal resistance of vacuum tubes as voltage dividers.

New Developments in Tubes

Electron multipliers and their characteristics were discussed in a series of three papers by members of the engineering staff of RCA Manufacturing Co. The first, "Analysis of Voltage-Controlled Electron Multipliers", was presented by B. J. Thompson. In it was discussed the

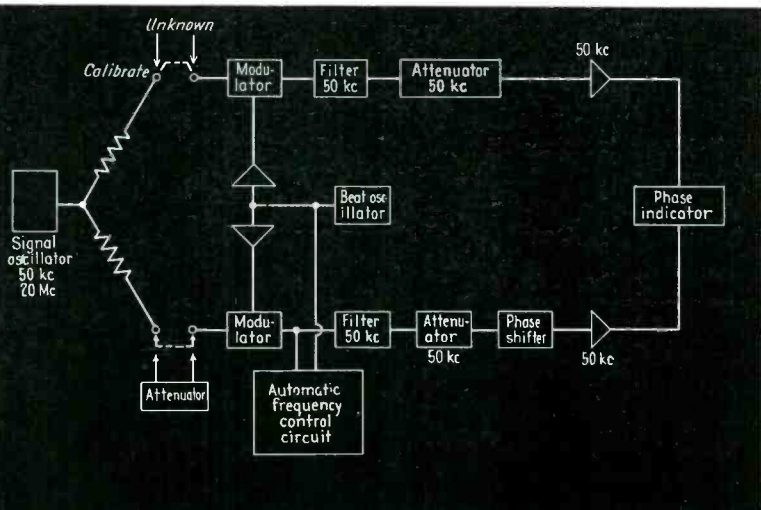

Setup for testing the characteristics of an unknown transmission line (Strieby and Weis)

Outline of the electron multiplier applied to a voltage amplifier (B. J. Thompson)

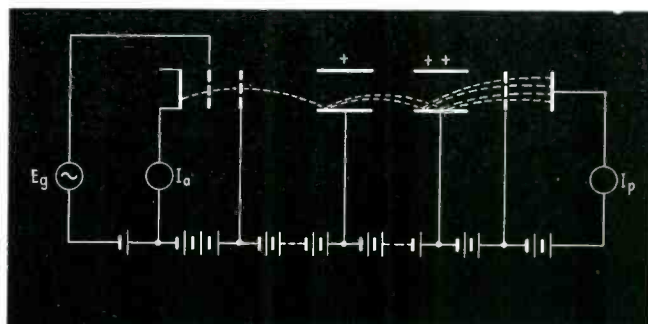

application of the electron multiplier to voltage amplifiers as well as to phototubes. It is theoretically possible to design voltage amplifiers having a transconductance of 2 mhos, or 2,000,000 micromhos, by incorporating an electron multiplier in such a tube. However, the transconductance is limited by the noise or the space current at the input to the multiplier and also by the ratio of transconductance to space current. An electronic device such as this finds its greatest usefulness in the ultrahigh-frequency range.

L. Malter discussed "Behavior of Electron Multipliers as a Function of Frequency". A series of experiments was conducted to investigate the loss in amplification of multipliers at the higher frequencies. It was shown that this loss is due to a difference in transit time of the individual electrons as they travel along their respective paths. This difference results because of differences in the initial velocities of the electrons and because the electrons originate at different points on the multiplier surfaces. Amplification loss is also the result of a finite time required for the secondary electrons to get started after the primary electron strikes the multiplier surface.

H. W. Wagner and W. R. Ferris presented a paper entitled "The Orbital-Beam Secondary-Electron Multiplier for Ultrahigh-Frequency Amplification" in which they described a tube now in the developmental stages in which an electron multiplier is applied to a conventional tube structure of high transconductance. The name "orbital-beam" is derived from the fact that the electrons follow an orbital path around the center of the structure. The tube is intended primarily for use in wide-band amplifiers operating at a frequency of about 500 Mc such as those used in television relay systems. The transconductance of the new tube is increased over that of the conventional tube without the corresponding increase of interelectrode capacitances. The orbital-beam tube is used in conventional circuits and requires a d-c voltage of less than 400 volts.

K. C. DeWalt of General Electric Co. described three new transmitting tubes which were designed to be used in the ultrahigh-frequency region, especially for television and frequency modulation. The tubes are

all triodes and are the GL-8002 which has a plate dissipation of 1250 watts; the GL-889 with a plate dissipation of 5 kw; and the GL-880 with a plate dissipation of 29 kw. All tubes are available with either water- or air-cooling. They have slightly higher frequency range with water cooling than with air cooling. In the GL-880 use is made of a re-entrant anode which is folded back on itself in such a manner that the leads to the grid and filament are reduced in length to about one quarter of those used in conventional designs. These short lead lengths result in better neutralization and more stable operation.

J. R. Pierce of the Bell Telephone Laboratories presented "After-acceleration and Deflection", a paper devoted to those properties of a cathode-ray tube. The speaker used the term deflection sensibility, defined as the change in deflection voltage or current to move the spot on the screen one spot diameter, in his discussion. After a mathematical analysis of the problem, it was concluded that certain improvements in operation result from accelerating the electron stream after it is deflected rather than deflecting the electron stream when it is at a high

potential, but that these improvements result from the low potentials in the deflection region rather than from any special properties possessed by after-acceleration systems. Use of after-acceleration result in savings in the construction of the power supply and reduces the problems of insulation.

"Signal-to-Noise Relations in High Transconductance Tubes" were discussed by J. R. Nelson of Raytheon Production Corp. In the standard broadcast band there is so much noise in the circuits that the tube noise is almost negligible. But recent developments in high frequencies, especially as far as receivers with no preselector circuits are concerned, have resulted in the converter tube being the bottleneck for noise. It is thus desirable to have a converter tube with a very low noise level. A number of tubes, both triodes and pentodes, were examined to determine the various noise levels and formulas were given to compare the gains possible by using the different tubes.

"A New One-Kilowatt Television Transmitter" was described by J. Ferguson of the Farnsworth Television and Radio Corp. This trans-

(Continued on page 84)

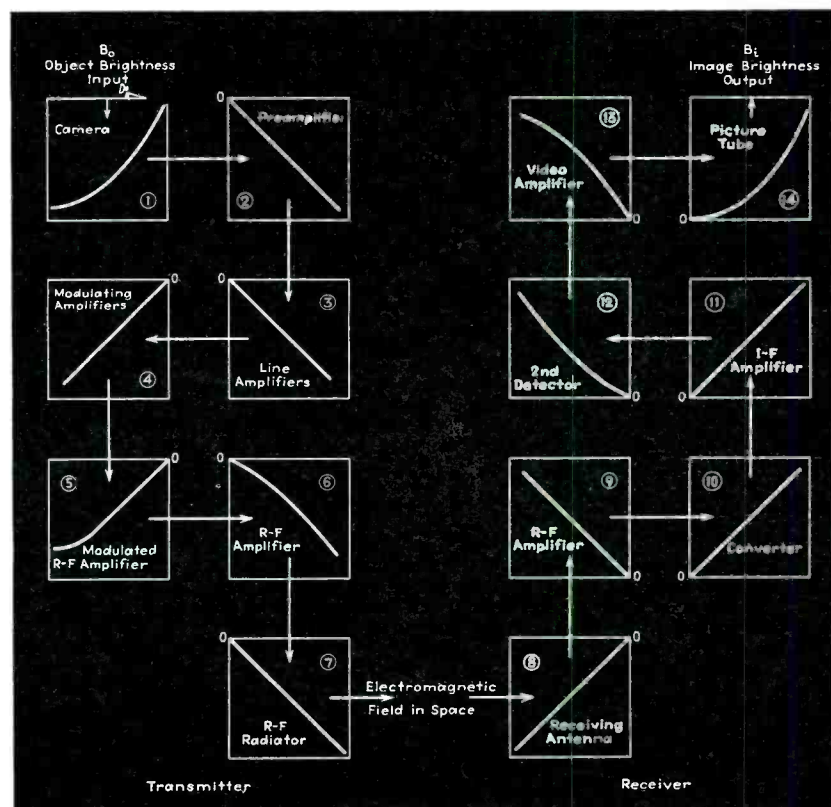

The transfer characteristics of a television system which may contribute brightness distortion (D. G. Fink)

Impulse Noise in F-M Reception

An investigation into the nature of impulsive noise in frequency modulation receivers, making extensive use of oscillographic records. The relative effects of the plate-volt and grid bias types of limiter on impulsive noise are compared and recommendations made to insure maximum noise reduction

By VERNDN D. LANDON

RCA Manufacturing Co., Inc.

IMPULSIVE noise in frequency-modulation receivers has already been studied and reported by M. G. Crosby¹ and others. The purpose of the present article is to carry out the study in more detail. Certain theoretical considerations are presented and oscillographic confirmation shown.

When a shock, such as a noise pulse, is applied to the input of a radio receiver, a wave train or pulsation passes through the amplifier. The output of the final stage of the amplifier is a wave train which is characteristic of that particular receiver. The frequency of the wave train is the frequency of the center of the pass band, and the time duration is $1/f_c$ where f_c is one-half of the bandwidth. Typical response waveforms are shown in Figs. 1A, 1B, and 1C. These oscillograms were taken on the 5 Mc intermediate frequency amplifier of a frequency modulation receiver having 200 kc bandwidth. In the cases illustrated

the time duration is about $\frac{1}{100,000}$ or 10 microseconds. Thus, there are about 50 cycles present in the main portion of the wave train. The shape of the envelope of this wave train is a function of the shape of the selectivity curve. There is a tendency for the voltage envelope to rise to a peak, drop to zero, and then reappear in the form of a secondary lobe with the phase of the radio frequency wave reversed. The size of the secondary lobe is a function of the shape of the nose of the selectivity curve. A slightly double peaked selectivity curve results in a marked secondary lobe as shown in Fig. 1A. The phase of the r-f wave reverses

at the valley between the lobes. A flat-topped selectivity curve gives a smaller lobe as shown at B. The lobe disappears as shown at C if the selectivity curve is round nosed. The valley between the main lobe and the secondary lobe goes to zero as in A if the selectivity curve is symmetrical. If one peak of the selectivity curve is higher than the other, the valley between the lobes does not go to zero as shown at D.

When a wave train such as that shown in Fig. 1A is fed to a discriminator of the type usually used in frequency-modulation receivers, the output has the form shown in Fig. 1G. If the circuit were perfectly balanced, the output would be zero for this condition. The residual wiggles are due to slight imperfections in the balance.

If one of the circuits of the receiver is detuned so as to give a selectivity curve with the low-frequency peak higher than the other, producing a wave train as in Fig. 1D, the discriminator output has the form shown at E. If the circuit is tuned to the other side making the high-frequency peak greater, the discriminator output changes to that shown at F.

Similar curves to E and F are obtained by mistuning the secondary of the discriminator one way or the other. Thus, it appears that the output of the discriminator goes plus or minus on the oscillogram according to whether the selectivity curve has more area above or below the frequency of resonance of the discriminator secondary. Oscillogram H of Fig. 1 shows the result of having the low-frequency peak exceed the high-frequency peak and of attempting to compensate by discriminator tuning. The indication is that the frequency of the pulse varies slightly with time for this condition.

The output network of the discriminator consists of two separate diode output circuits connected in series. The fidelity of these two circuits should be the same for a good balance, but this is not usually obtained. The output circuit is grounded on one side instead of in the center. This usually results in more capacitance across one side than across the other. This can be compensated for by adding capacitance to the other side. The effect of a capacitance unbalance of 10 micromicrofarads across 100,000 ohms is shown at I in Fig. 1.

Change of Tuning with Signal Strength

An unfortunate effect is the change in tuning with signal strength. This is illustrated in Fig. 2. The oscillograms of this figure were taken in the output circuit of a limiter. Limiter action was obtained because of grid current and because of the low plate voltage employed. At A the input level was too low for limiting to take place. The narrow neck between lobes indicates accurate alignment. The oscillograms at B and C were taken at progressively higher signal levels. The deep valley between lobes is missing indicating that certain circuits were detuned. The corresponding oscillograms of discriminator output are shown at D, E and F. The fact that E and F go negative shows that certain circuits are tuned to a lower frequency at the higher signal level. The circuit which is detuned most is the grid circuit of the limiter. This is proved by the next six oscillograms. These repeat the conditions of the preceding six except that the grid of the limiter is now fed by a tuned circuit having 600 micromicrofarads instead of 100 micromicrofarads for a tuning condenser. The detuning at high signal

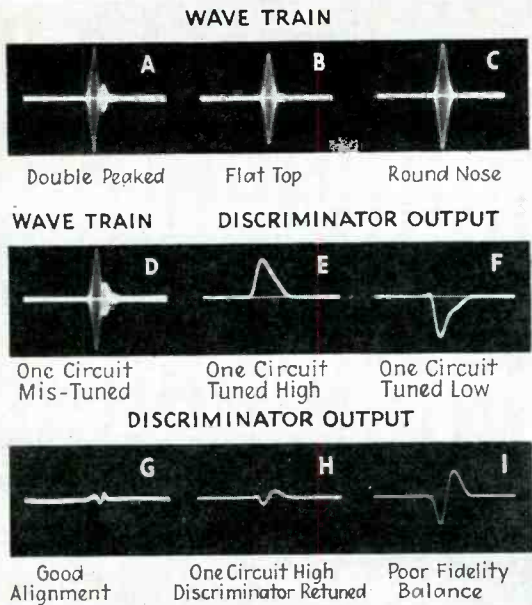

Fig. 1—Oscilloscope wave train and output of discriminator for various conditions of tuning

Fig. 3—Right, oscilloscope wave train and discriminator output for various phase angles between the noise impulse and signal at two ratios of signal-to-noise with the carrier centered in the pass band

level is correspondingly less as illustrated by the deep valley between lobes at H and I and the smaller negative deflection at K and L.

The detuning caused by grid current can also be minimized by other methods. If the affected transformer is made broader than the preceding stages the detuning will not affect the overall performance. It also helps if the Q of the primary and the Q of the secondary are equal and if the coupling is less than critical in the affected transformer.

Noise and Signal Applied Together

When signals are being received, all the foregoing comments will apply only if the noise exceeds the carrier by about ten times or more. It is more usual for the noise to be less than the carrier or about equal to it. Under these conditions the noise output is a function of the reaction between the noise wave train and the carrier wave. The noise may come through purely as amplitude modulation, as frequency modulation, or as both, depending on the relative phase angle between the noise wave and the carrier wave.

To demonstrate these facts with an oscillograph it was necessary to build some special equipment. The

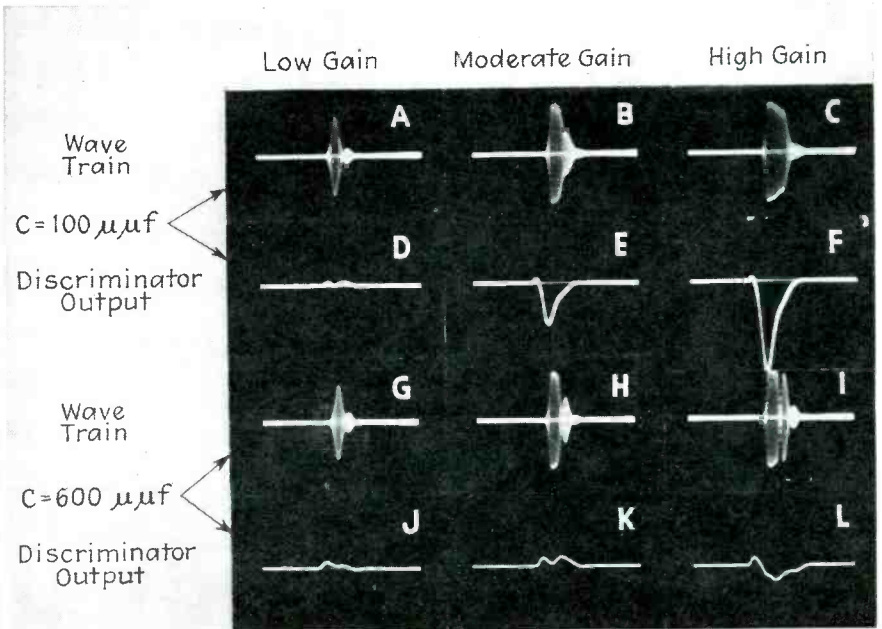
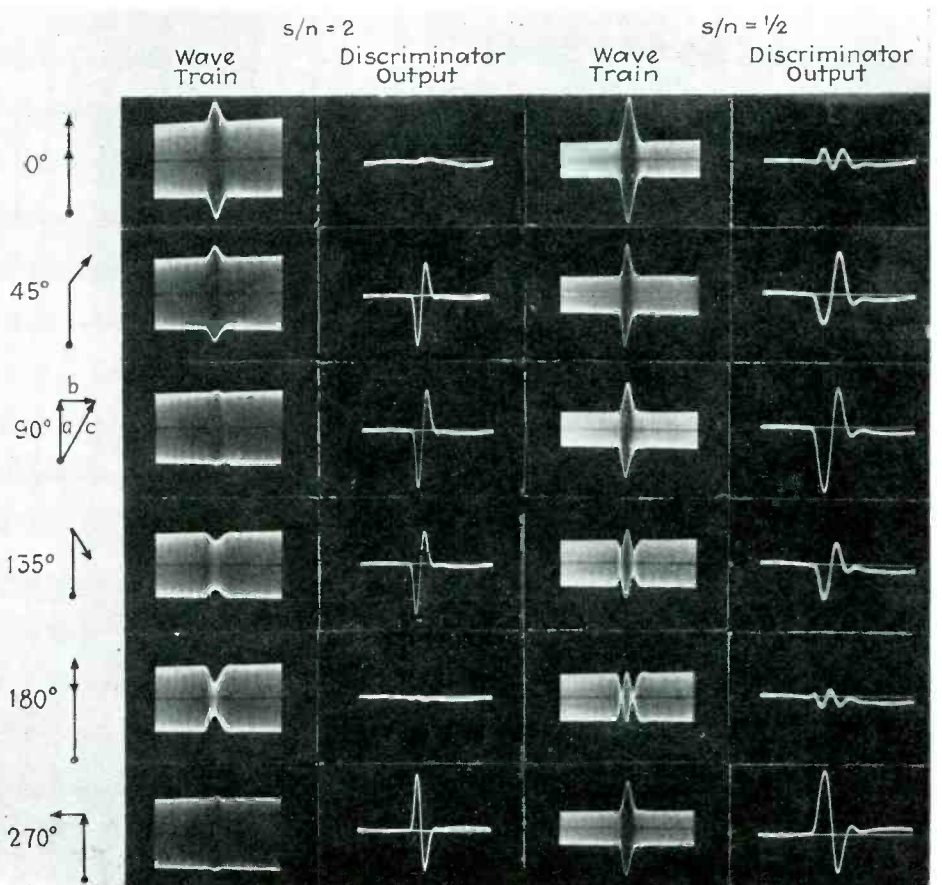

Fig. 2—Oscilloscope wave train and output of discriminator showing detuning due to grid current at higher amplitudes



difficulty with ordinary equipment is to synchronize the impulse generator with the signal generator so that the relative phase stays constant. Synchronization is obviously almost impossible with separate sources. To get around this difficulty the two waves were obtained from

the same source. The source chosen was a 10,000 cps oscillator which was fed into two channels. In one channel the frequency was multiplied through a succession of stages up to the desired frequency of 5 megacycles. In the other channel the 10,000 cps wave was used to generate

very narrow unidirectional pulses at the rate of 10,000 per second. The impulses and the 5-Mc signal were applied simultaneously to the input of a 5-Mc amplifier having a 200-kc bandwidth. Since the carrier wave and the impulses had a common source, the wave trains due to the impulses always had the same phase relative to the carrier. However,

the relative phase was adjustable by a slight change in the tuning of one of the circuits in the frequency multiplier.

Some of the oscillograms taken with this equipment are shown in Fig. 3. In this figure the vertical column of oscillograms on the left illustrates the resultant wave form when the noise wave and the car-

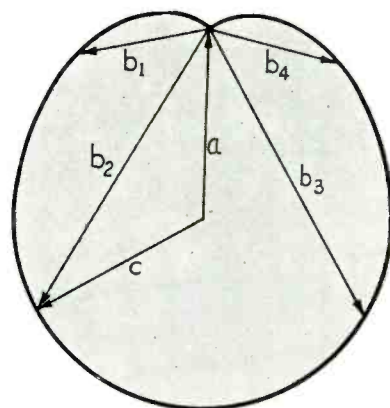

Fig. 6—Vector diagram corresponding to Fig. 5. Signal-to-noise ratio is 0.5. Relative phase is 180 degrees at peak of noise

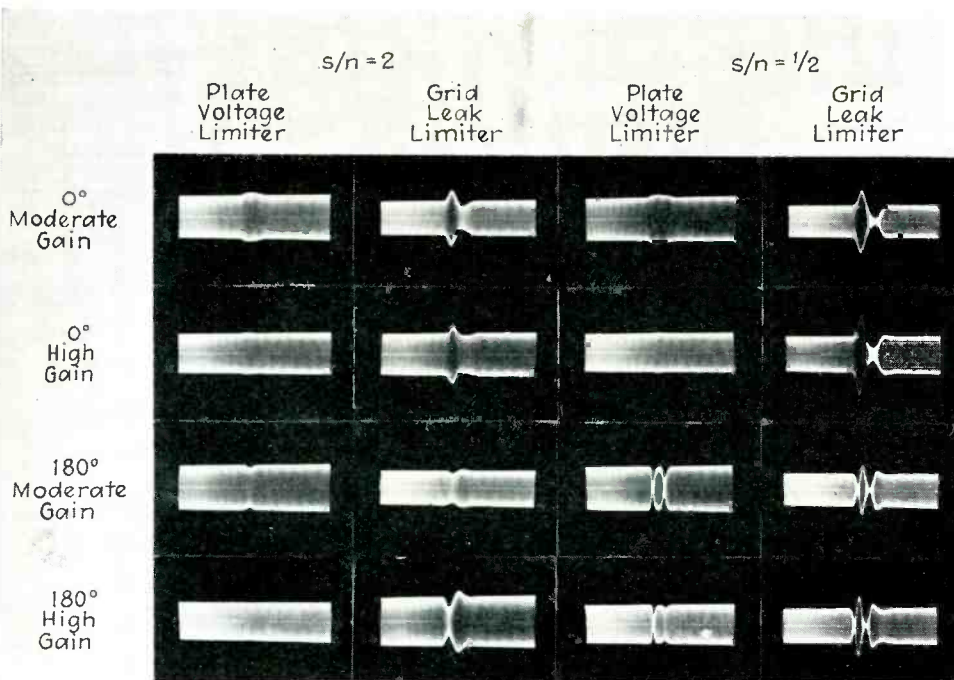
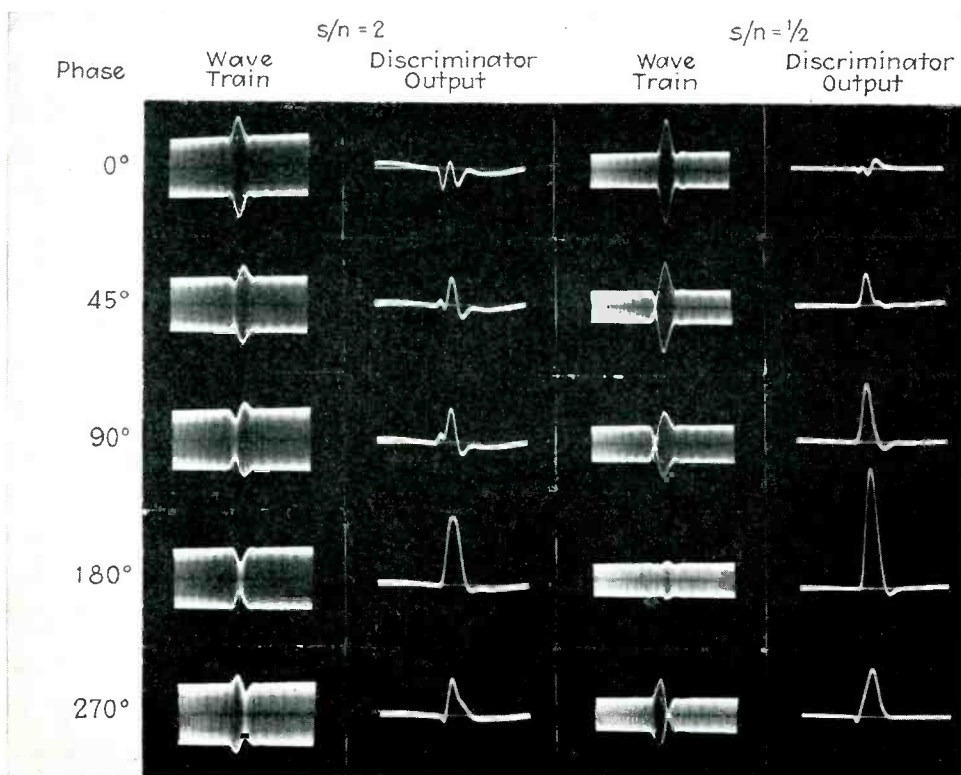

Fig. 4—(above) Oscillograms demonstrating the relative effectiveness of plate voltage and grid leak limiters . . . Fig. 5—(below) Oscillograms of noise and discriminator output with carrier tuned to edge of the pass band



rier wave are added with various phase angles. The second column illustrates the output of the discriminator for the same conditions. It can be seen that the zero and 180-degree phase angles produce the maximum amount of amplitude modulation and the minimum output from the discriminator. The 90-degree and 270-degree phase angles produce minimum amplitude modulation and maximum output from the discriminator. The intermediate phase angles produce both types of modulation.

The fact that the 90-degree phase angle produces the equivalent of frequency modulation can be seen by referring to the vector diagram on the left. The vector a represents the carrier wave, the vector b represents the noise wave at the instant of its peak value and the vector c represents the resultant when a and b are added. For the first half of the duration of the noise wave the vector b is growing. For the second half it is diminishing. During the time interval when b is growing, the phase angle between a and c is growing. Since frequency is the rate of change of angle, the frequency of the vector c is low during the growth of b and high while b is decreasing. If b is much smaller than a so that the angle is equal to its sine, then the frequency deviation is proportional to the rate of change of b .

In an amplitude-modulation receiver the output is a maximum for a 0-degree or 180-degree phase angle and the output wave form follows the envelope of the noise wave

train. In a frequency-modulation receiver the output is a maximum at a 90-degree or 270-degree phase angle, and the output waveform is the first derivative of the envelope of the noise wave train. It should be noted that the output of the discriminator for 270 degrees is inverted compared to that for 90 degrees.

Columns 3 and 4 in Fig. 3 repeat the same tests except that a different signal-to-noise ratio was used. For columns 1 and 2 the signal amplitude was twice that of the noise. For columns 3 and 4 the signal had half the noise amplitude. It can be seen that with the stronger relative value of noise, the noise shows up as a peak even for the 90-degree and 135-degree phase angles. For 180 degrees the noise bucks out the carrier completely and in addition there is a lobe in which the r-f voltage is 180 degrees out of phase with the carrier. In spite of these differences the output of the discriminator has very much the same waveform for one signal noise ratio as for the other. This may be due to the inability of the audio circuit to follow the higher-frequency components of the true wave form. The fidelity would probably have to be flat to several hundred kilocycles to follow the output waveform accurately.

Effectiveness of Limiter

Oscillograms of this nature can be used to test the effectiveness of various types of limiters as demonstrated by Fig. 4. In this figure the first column of oscillograms is for a signal-to-noise ratio of 2 and shows the output of a plate voltage limiter. This type limiter obtains the lim-

iting action by using a very low plate voltage. The r-f plate voltage swing is limited to something less than the d-c plate voltage employed.

The first oscillogram of the left-hand column is for 0 degrees phase angle with a moderate amount of gain so that only partial limiting is obtained. For the second oscillogram the gain was increased so that

limiter action was almost perfect. The third and fourth repeat the conditions except that the phase angle between signal and noise is 180 degrees. This shows that the plate voltage limiter is a rather good limiter.

The second column of oscillograms is for a grid-leak limiter. This type of limiter obtains the limiting action by allowing the tube to bias itself off as the signal increases in amplitude. It is obviously important to keep the circuit response as fast as possible. For these oscillograms 100,000 ohms and 20 micromicrofarads were used. The other conditions for the second column are the same as for the first. These tests seem to indicate that the grid-leak limiter is not as satisfactory as the plate voltage type. The grid condenser apparently cannot charge up rapidly enough to follow the pulsation. However, it does build up some extra bias during the pulsation, and after it is over, the carrier is attenuated for a short time until the extra bias leaks off.

The third and fourth columns in Fig. 4 repeat the conditions of the

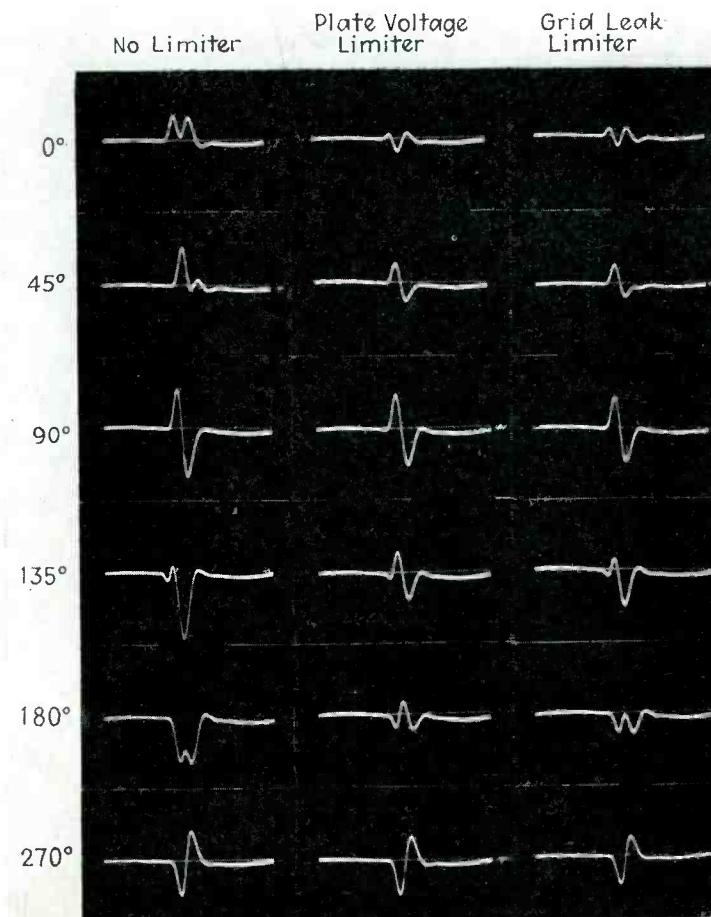

Fig. 7—Oscillograms illustrating noise reduction by plate voltage and grid leak limiters

NOISE MUCH LESS THAN SIGNAL		
CIRCUIT CONDITIONS	SIGNAL CENTERED **	SIGNAL SLIGHTLY DETUNED
Limiter In, Symmetry Perfect.....	Good*	Good
Limiter In, Symmetry Poor.....	Good	Good
Limiter Out, Symmetry Perfect.....	Good	Poor
Limiter Out, Symmetry Poor.....	Good	Poor
NOISE MUCH STRONGER THAN SIGNAL		
CIRCUIT CONDITIONS	SIGNAL CENTERED **	SIGNAL SLIGHTLY DETUNED
Limiter In, Symmetry Perfect.....	Good*	Fair
Limiter In, Symmetry Poor.....	Fair	Fair
Limiter Out, Symmetry Perfect.....	Good	Fair
Limiter Out, Symmetry Poor.....	Poor	Poor

* Relative terms apply throughout one table, but not from one table to the other.
 ** Signal centered for zero discriminator output.

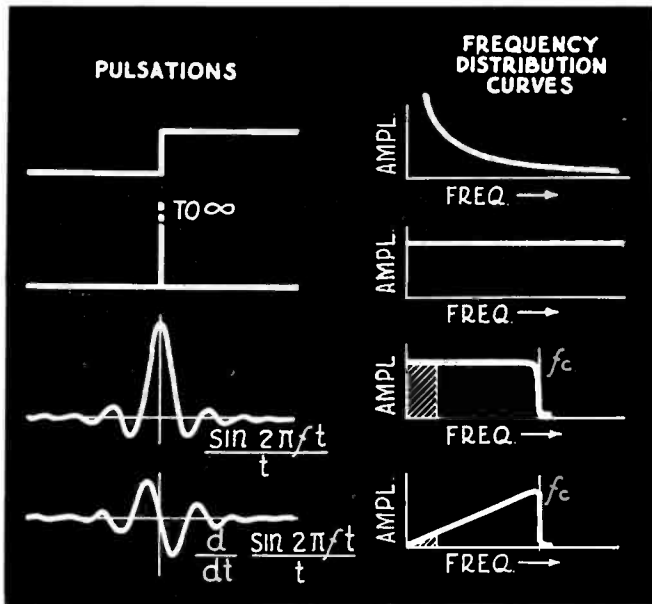

Fig. 8—Various types of pulsations and the corresponding curves of relative amplitude vs frequency

first and second except that the noise amplitude is twice that of the signal. For a phase angle of 0 degrees the plate voltage limiter still does a good job, but the defects of the grid-leak limiter are magnified. For a phase of 180 degrees even the plate-voltage limiter fails as it obviously must since the phase of the resultant wave is reversed during the central portion of the noise pulse.

Noise with Carrier Detuned

As a matter of fact, these oscillograms are not as important as they seem at first sight. As was shown in Fig. 3, amplitude modulation does not come through the discriminator when the noise pulse and the carrier are synchronous. Thus, a limiter does no good under conditions of no modulation if the signal carrier is tuned to the center of the pass band.

Actually, the limiter action may make the noise worse, as was shown in Fig. 2 in which grid current was shown to detune the corresponding tuned circuit. This is also illustrated in the bottom oscillogram of the third column of Fig. 4. It will be noted that the valley at the end of the lobe is not as deep as it should be. This is a sign of detuning due to grid current.

The only time a limiter helps to reduce the noise is when the carrier is not in the center of the pass band because of mistuning or modulation. If the carrier wave is tuned to the

edge of the pass band, there is a beating action between the noise wave train and the carrier wave. The frequency of the beat note is f_c where f_c is one-half the bandwidth of the receiver. Thus, the beat note goes through one cycle in a period of time equal to $1/f_c$. However, the duration of the pulse itself is also $1/f_c$ (this is accurately true in a sharp cutoff filter and roughly true in any filter depending on what per cent of peak amplitude is called cut-off). Thus, the beat note goes through one complete cycle in the duration of the noise wave train. This is illustrated in Figure 5. In the first oscillogram of the first column, the noise wave starts out 180 degrees out of phase with the carrier wave. As the noise wave grows, it gradually changes its phase relative to the carrier so that at the peak of the pulse it is in phase. The relative phase continues to change for the duration of the pulse so that at the end of the pulse it is again 180 degrees. Since the relative phase assumes all possible values in the duration of each pulse it is difficult to assign a value to it. However, the relative phase at the peak of the pulse has a definite meaning and it is on this basis that the various oscillograms of the first column are labelled. It can be seen that as the relative phase is changed, the valley of the beat note travels progressively across the noise pulse. The corresponding output of the discriminator is shown in the second column.

For the detuned condition characteristic of the oscillograms of Fig. 5, it can be seen that the greatest noise output occurs for the 180-degree position. This can be partially explained simply on the basis of amplitude modulation. The carrier alone is producing a d-c output corresponding to peak frequency deviation on the discriminator curve. The reduced amplitude during the pulse reduces the d-c output voltage momentarily.

The third and fourth columns of Fig. 5 repeat the conditions of the first and second columns except that the signal-to-noise ratio is changed from 2 to $\frac{1}{2}$. A curious effect is obtained in the third column for 180-degree phase angle. For this condition the amplitude-modulation component disappears almost completely. In spite of the fact, the noise output is a maximum for this phase angle. The reason for this is shown in Fig. 6. The vector a represents the carrier wave and the vectors b_1, b_2, b_3 and b_4 represent the successive values assumed by the noise pulse. The vector c represents the resultant wave (shown in one position only). Obviously c makes one complete revolution around the origin. In other words the resultant wave picks up one extra cycle in the duration of the pulse. The angular velocity of the vector c is twice that of b at the peak value of b . Thus, at the peak of the pulse the resultant wave has an instantaneous frequency lying at the opposite edge of the pass band from the signal carrier wave. This results in maximum noise output. If similar circle diagrams are drawn for the other phase angles, they account for the results quite well.

Effectiveness of Limiter with Signal Detuned

Obviously a limiter can do practically no good for the set of conditions illustrated by Fig. 6, since there is almost no amplitude modulation present. It is also true that the limiter does little good at any phase angle if the noise is stronger than the signal. For cases where the signal is stronger than the noise, and the signal is tuned to the edge of the pass band (columns 1 and 2, Fig. 5) the limiter can do a certain amount of good, as is illustrated in Fig. 7. Column 1 of this figure is

(Continued on page 73)

Applying Magnetic Relays for Sensitive Control

The second of two articles discussing the applications of magnetic contact relays. A comparison of magnetic and non-magnetic contact relays for certain applications are given. Also, the various methods of resetting the magnetic contact relays are described

By ANTHONY H. LAMB

Weston Electrical Instrument Corp.

A NUMBER of automatic alarm and control units which have acquired commercial importance were described in a previous article (*ELECTRONICS*, December 1940) indicating the range of successful application of sensitive relays of the magnetic contact type. Actuated in many cases by a current of 5 microamperes or less, this type of relay was shown to provide a positive contact capable of handling 5 watts at 110 volts, with sufficient reliability to justify use on equipment responsible for the safety of hundreds of lives in mines, on shipboard and in the air.

Out of the writer's experience in working with those who developed these units, assisting in the selection of relay equipment which would best meet the circuit conditions and other features of the overall design, a number of significant facts have come to light. It appears that a saving in time and effort in future development work may be made possible by a review of the practical design factors influencing relay selection.

Perhaps the first question likely to arise when the use of magnetic contact relays is suggested is this: "Why should it be necessary for us to use a relay requiring resetting (separation of magnetic contacts), rather than one with the ordinary type of contact points?"

As non-magnetic contact relays are not ordinarily supplied to operate on less than 15 microamperes or less than 50 millivolts, any need for sensitivity in excess of these levels is bound to be a determining factor. Even at this level, relays without magnetic contacts tend to chatter and act erratically, and acceptable performance usually requires relays that are several times larger and more expensive than the magnetic-contact type. In addition, non-magnetic contacts are limited to 6-volt d-c circuits, and thus require a 6-volt battery or rectifier-transformer combination, plus an

auxiliary power relay to operate any 110-volt load, no matter how small the load may be.

For application to a-c circuits, magnetic contact relays require only the addition of a small copper-oxide rectifier, and they are regularly supplied to operate down to 10 microamperes ac and down to 0.5 volts ac. The frequency of the ac is unimportant, as the magnetic contact eliminates the tendency to chatter when the contact closes. Non-magnetic contact relays chatter badly on rectified ac and are, therefore, not used in such circuits.

In contrast to electronic controls

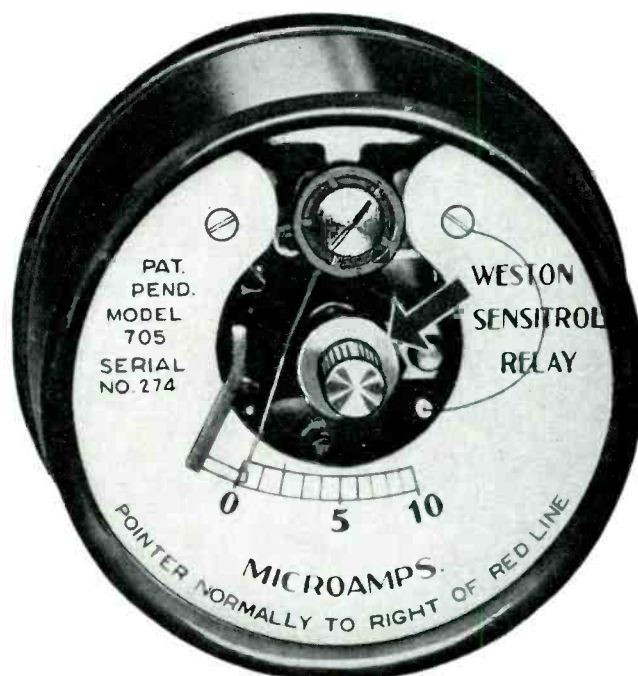

Fig. 1—A manual reset magnetic contact relay. The resetting knob is indicated by arrow

the magnetic contact relay requires no continuous consumption of current, as does the heater element of a tube, nor a source of plate voltage. The relay contacts close at exact, though adjustable, values independent of line voltage or any other circuit variation, holding to a permanence of calibration which is not possible with a simple electronic amplifier. In addition, the relays will operate either 120-volt a-c or 120-volt d-c circuits equally well, which is not the case with grid glow tubes and some other types of electronic tubes.

Even where extreme sensitivity is not a determining factor, relays of the magnetic contact type are also frequently advised in applications in which the power available to actuate the relay is well above the limiting value for ordinary sensitive relays, in the range of 1 to 5 milliamperes, for example. Among the factors which will have considerable weight under these circumstances are the following:—

(1) The need for a high order of reliability when the operation of the relay takes place only at infrequent intervals. In an alarm device, for example, the relay may not be called on to operate, except for tests, for long periods of time, with the possibility that dust or other material interfering with clean contacts may have a chance to accumulate between operating periods.

(2) The desirability of a "snappy," non-chattering response when the actuating energy builds up slowly to the level at which the relay is set to close. Illumination control units operated from photo-electric cells, for example, must act at the same level whether the change in actuating current is sudden or very gradual, perhaps a microampere or less per hour as daylight changes, without arcing or burning at the points.

(3) The advantages of a self-contained indicating scale. In many applications such as the smoke alarm unit designed for power plant use, an indication that the point at which the relay is set to operate is being approached may be valuable to users. Yet, due to electrical or space limitations, it may be impossible or undesirable to employ a separate indicating microammeter. Where separate indication is necessary, as in connection with some electronic amplifiers, it necessarily adds to cost.

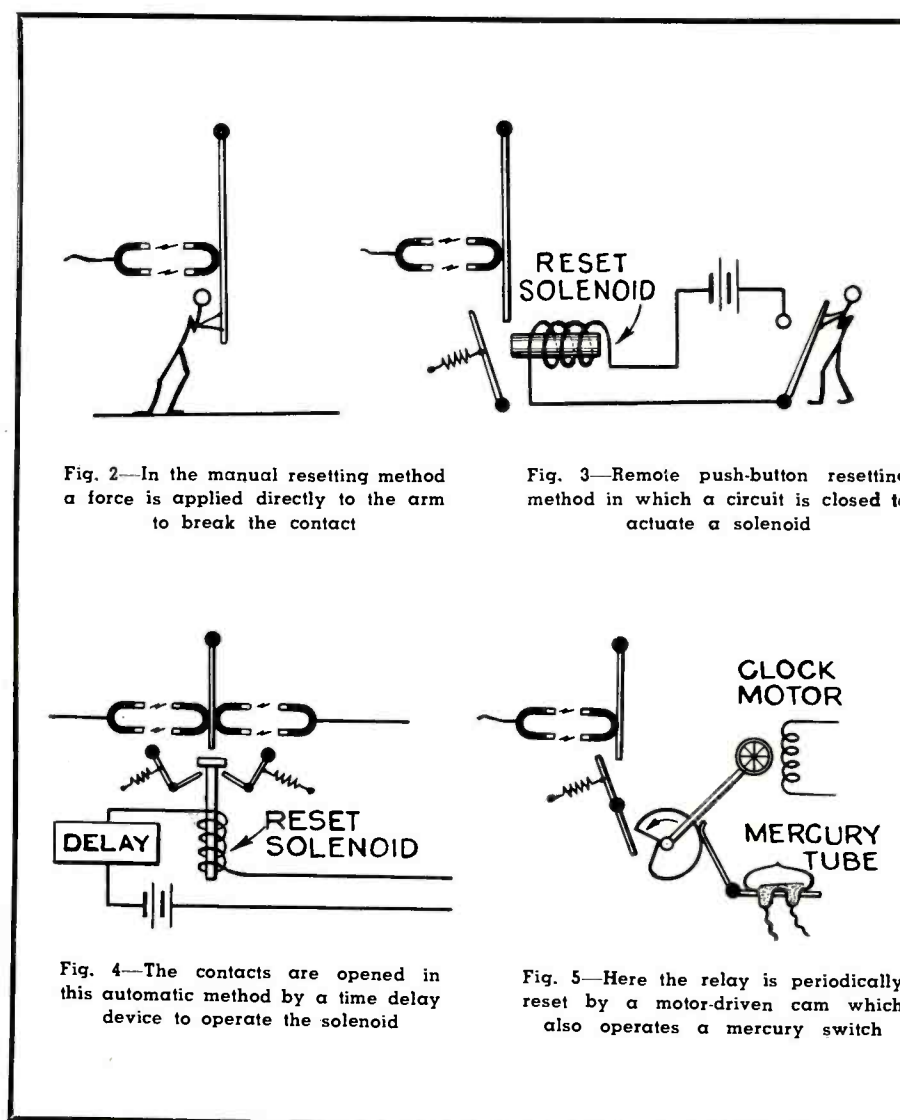

Fig. 2—In the manual resetting method a force is applied directly to the arm to break the contact

Fig. 3—Remote push-button resetting method in which a circuit is closed to actuate a solenoid

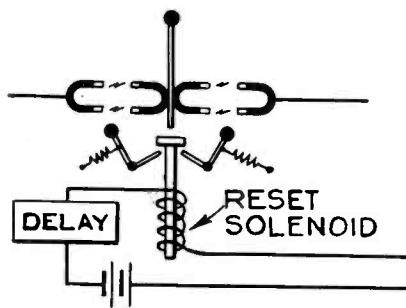

Fig. 4—The contacts are opened in this automatic method by a time delay device to operate the solenoid

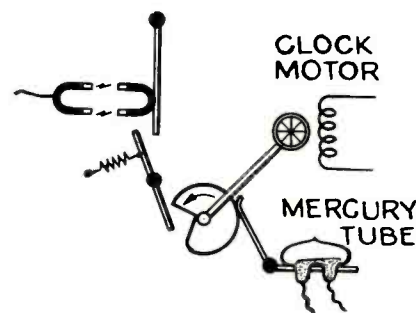

Fig. 5—Here the relay is periodically reset by a motor-driven cam which also operates a mercury switch

The indicating scale of the magnetic contact relay may be calibrated in units appropriate to the application, such as gas concentration, temperature, footcandles, etc.

(4) The usefulness of calibrated contact adjustment. Applications in which the level at which the relay operates must be subject to simple and rapid adjustment are frequently encountered. These are simply met by a type of magnetic contact relay in which the fixed contact is adjustable to a range of operating values on the calibrated indicating scale by means of a knob or adjusting screw on the front of the dial.

Periodicity of Response

Another factor which often has a primary influence on the selection of relays and, in particular, on the satisfactory use of the magnetic contact type, concerns the periodicity of relay operation, in other words, the rate at which successive contact-

making impulses are likely to occur. For example, in applications where a single positive closure of the relay is required, remaining in effect until some manual action is taken regardless of subsequent changes in the actuating condition, use of the magnetic contact relay permits a particularly simple arrangement. Such is the case for many alarm units where some individual is charged with responsibility for correcting the condition and resetting the alarm.

In other situations, an automatic reset may be desirable, but with a delay for a certain length of time between successive responses of the relay. That is, in certain control applications closure of the relay may set in motion a series of electrical or mechanical steps, and it may be desirable that the relay be returned to its "on guard" position only after time has elapsed for certain readjustments to take place. This can be

arranged simply and easily with the magnetic contact relay by controlling the resetting of the relay with a clock mechanism or time-delay switch. Similarly, where the completion of some mechanical change should precede returning the relay to action, it is usually not difficult to correlate resetting with completion of the change, either mechanically or electrically.

Where the relay must operate repetitively in rapid succession, as in a high-speed counting operation, magnetic contact relays have a relatively limited application. By the use of the solenoid reset feature,

on increasing and decreasing values at either side of a normal open circuit zone.

Methods of Reset

Perhaps the best evidence that the scope of application for magnetic contact relays has not been seriously limited by the need for reset is supplied by present commercial units. The specific methods of reset now being employed on one or more types of automatic-response devices in the fields previously described will serve this purpose:—

Gas Detector (Fig. 2):—Reset manually after an alarm is sounded.

which initiates opening of valves or otherwise starts flow. Other units go through filling, emptying cycles automatically using automatic reset.

Vehicle-Actuated Traffic Light (Fig. 7):—Reset automatically by same motor which carries out the signal sequence.

Carrier Current Remote Control (Fig. 8):—Reset automatically by a motor which starts when magnetic contact closes. This motor also operates a pair of large contacts.

Information for Relay Selection

Both the choice of a type of relay and the choice of the particular relay

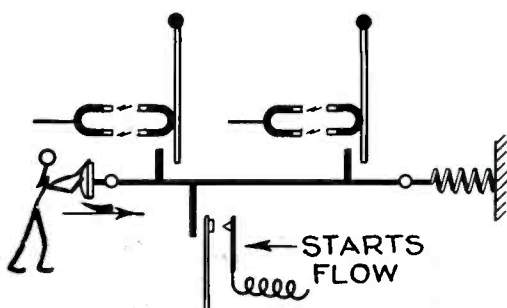

Fig. 6—The same push button can be used to reset several relays and also to start the associated operation

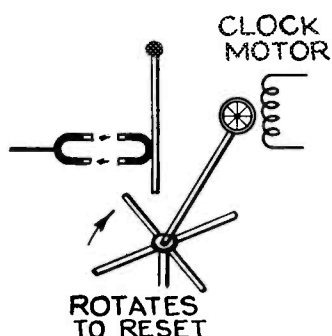

Fig. 7—The relay can be automatically reset by a motor which also controls other phases of the system

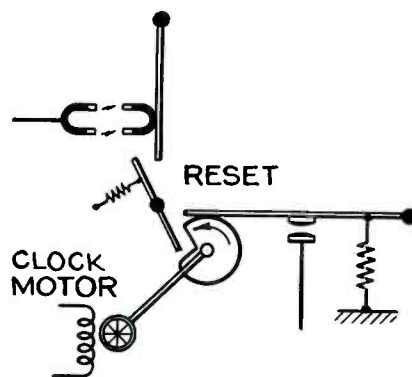

Fig. 8—Automatic resetting can be accomplished by the use of a motor which starts when the contacts close

however, it is possible to meet requirements for repetitive response up to about 30 contact-making cycles per minute.

The fact that the magnetic contact relay "makes" contact at a calibrated value but does not "break" contact with a subsequent decrease in the actuating energy below this level is a less serious limitation than it may appear initially. For example, where the sensitivity requirements are more extreme than a sensitive make-and-break relay can reliably cope with, the use of two magnetic contact relays, one "making" on the energy increase and one set to close on the subsequent decrease can be incorporated in the circuit, if need be, to perform the same functions. This is the system used in a commercial type of illumination control relay. A double fixed contact relay with automatic solenoid reset is also available for related applications where it is desired to make contact

Here manual reset is desirable as a means of establishing responsibility. Silencing the alarm is possible only when gas concentration has returned to safe level, otherwise the relay immediately recloses to continue it.

Fire Detector (Fig. 3):—Reset by remote push button controlling solenoid, after smoke conditions have been returned to normal. Relay cannot be directly reset, being located in a locked cabinet.

Telephone Line-Level Control (Fig. 4):—Reset automatically through a time delay unit so that a reversible motor can make preset correction. Device pulses until complete correction is accomplished.

Airway Photoelectric Control (Fig. 5):—Reset automatically by motor-driven lever which also operates a 30-ampere mercury contactor.

Automatic Weighing (Fig. 6):—Reset manually by same push button

with respect to range and other operating specifications requires a more careful review of the entire combination of circuit conditions, mechanical operating conditions and service needs than is sometimes accorded it. Time can always be saved and many "blind alleys" in development avoided by furnishing the relay manufacturer with complete information as to the limiting conditions under which the relay is to be used:—

1. High or low contact adjustment (or both) in current or voltage.
2. The values of voltage and current in local circuit.
3. Inductive circuit or non-inductive circuit.
4. The values of resistance, inductance or capacitance in the circuit.
5. Accuracy limits.
6. If power relays or other auxiliary apparatus are to be employed, describe fully.

(Continued on page 89)

BINAURAL TRANSMISSION ON A SINGLE CHANNEL

By transmitting two sets of sidebands, one displaced 90 degrees from the other, two separate audio-signals may be transmitted over a single r-f channel. The system, which employs amplitude and frequency modulated signals simultaneously, has been successfully demonstrated in the laboratory

By **AUSTIN V. EASTMAN**

University of Washington

and **JOHN R. WOODWARD**

Stanford University

WHEN sound is transmitted by the ordinary system over telephone lines or by radio, only a single channel is provided, and audio perspective is entirely lost since the phase displacement between the sounds received by the two ears bears no relation to what happens at the transmitter. Binaural reception has been demonstrated using two microphones, set up at suitable locations on each side of a stage on which the orchestra was seated. Each microphone is connected by a separate telephone channel to one of two loud speakers placed similarly to the microphones but on the stage of another auditorium. To those listening in the second auditorium the auditory effect is nearly the same as though the orchestra were actually playing on the stage instead of being reproduced by loud speakers.

Another demonstration¹ used a dummy with two microphones placed on its head instead of ears. Each microphone was connected by a separate channel to one receiver of a double head-set. When the headsets were worn by spectators they found themselves effectively removed to the location of the dummy's head insofar as sounds were concerned. The demonstration was so realistic that when some one stepped up behind the dummy and asked him to turn around a number of the listeners actually did so before they realized from whence the sounds had come.

While binaural systems may be applied to radio channels just as readily as to wire circuits there is

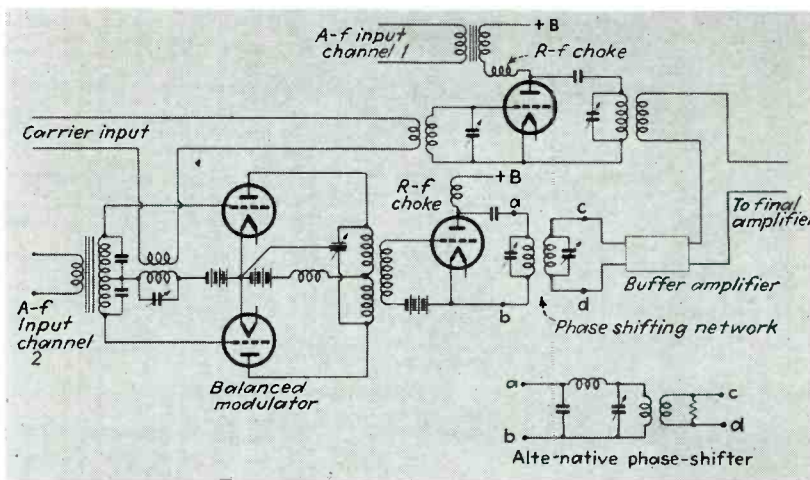

Fig. 1—Combination of a conventional amplitude modulator and a balanced modulator with a 90-degree phase-shift network, used for combining two audio inputs on a single carrier

one very serious obstacle from a practical point of view, that is the need for two separate channels for the transmission of a single program. This means that the extension of binaural transmission to the broadcast band is practically prohibited until the development of some new method which will eliminate the need of two separate radio channels. Evidently the desirable solution would permit transmission of both audio channels over the same carrier frequency, thus using but one radio channel and reducing to a minimum the additional investment required to convert one of the present "monaural" transmitters to handle a binaural system.

A comparatively simple solution along these lines is shown in the diagram of Fig. 1. If this is compared with a conventional transmitter, the additional equipment required is seen to be a balanced modulator preceded by a phase-shifting network, together with the

necessary audio equipment for handling the second channel. The function of the balanced modulator and phase-shifting network is to provide a second set of sidebands displaced 90 degrees from the first (or normal) set.

It is well known that an amplitude-modulated wave in which the carrier has been shifted 90 degrees is a good approximation of a frequency-modulated wave in which the amount of frequency swing is small compared with the applied audio frequency and is proportional to the audio frequency. Thus, the transmitter may be thought of as one in which the signal from the first microphone is transmitted by amplitude modulation, and that from the second microphone is transmitted by frequency modulation, both on the same carrier with the bandwidth due to both modulations being no greater than that of a conventional transmitter. A conventional receiver, when accurately tuned, will

reproduce the signal from the first microphone but will not respond to that from the second, while a modified receiver, described in a later paragraph, will respond to the signal from the second microphone but not to that from the first.

The operation of the system shown in Fig. 1 may be explained by means of vector diagrams as in Fig. 2. Fig. 2A represents normal amplitude modulation with the carrier being represented by vector 1. Actually, this vector must rotate at an angular velocity ω , where the carrier frequency is $\omega/2\pi$, but if the vector is assumed to be a mechanical arrow rotating at this velocity and illuminated by a stroboscopic light of carrier frequency, it would appear to stand still. Similarly the upper sideband may be represented by vector 2, for any given audio frequency, rotating at an angular velocity $\omega + q$, where the audio frequency is $q/2\pi$. When illuminated by the stroboscopic light this vector will evidently appear to rotate in a *counterclockwise* direction at a velocity q . In a similar manner vector 3 will represent the lower sideband, apparently revolving in a *clockwise* direction at a velocity q .

Fig. 2B shows three similar vectors to represent the carrier and sidebands in the additional modulator of Fig. 1. The carrier is shifted 90 degrees and the sideband vectors are spaced equally on either side of this carrier. Since a balanced modulator is used the carrier is removed and the vectors shown in Fig. 2C represent the output. When the outputs of the two modulators are combined the result will be a single carrier and two sets of sidebands as shown in Fig. 2D.

The expression for the total output as shown in Fig. 2D is

$$e = E \sin \omega t + \frac{aE}{2} \sin (\omega + q) t + \frac{aE}{2} \sin (\omega - q) t + \frac{aE}{2} \cos (\omega + q) t + \frac{aE}{2} \cos (\omega - q) t \quad (1)$$

At the receiver only sidebands 2 and 3 of Fig. 2D will produce an audio output provided the gain of the receiver at the two frequencies $(\omega + q)/2\pi$ and $(\omega - q)/2\pi$ is the same. The receiver must be either so broadly tuned as to provide equal

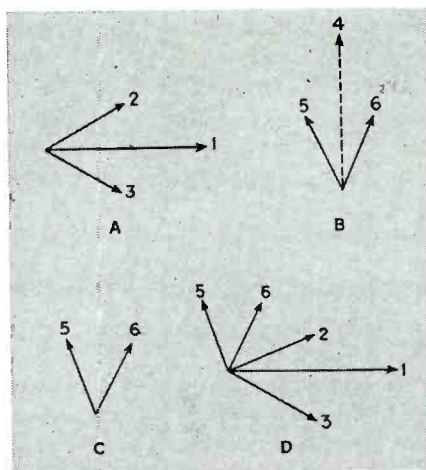

Fig. 2—Vector relationships of the two sets of sidebands, the combined signal representing simultaneous amplitude and frequency modulation

response over the entire bandwidth or tuned to exact resonance so that the attenuation of both sidebands is the same. Under these conditions the two audio components of frequency $q/2\pi$ resulting from the interaction of sidebands 2 and 3 with the carrier will be additive while those resulting from the interaction of sidebands 5 and 6 will be opposite in phase and will cancel.

Proof of the foregoing may be readily made for a receiver using a square law detector. The equation of the detector current, in terms of the applied voltage, is

$$i = I_0 + Ae + Be^2 \quad (2)$$

where I_0 is the quiescent d-c component of current flowing, e is the impressed voltage given by Equation (1), and A and B are constants whose magnitudes are determined by the characteristics of the detector. When Equation (1) is substituted in (2) and the terms expanded to segregate the various frequency components it will be found that the statements of the preceding paragraph are correct. Similar results

will be obtained with a linear detector.

It is quite possible to construct a receiver which is capable of reproducing the audio signal from sidebands 5 and 6 instead of from 2 and 3. One method of so doing has been described by one of the authors.² As used in the present application, the process consists essentially of shifting the phase of the carrier at the receiver by 90 degrees and then applying ordinary detecting methods. Thus, sidebands 5 and 6 will be placed in the same phase relative to the shifted carrier as were 2 and 3 before shifting, while 2 and 3 will be placed in the position of 5 and 6 (except for a phase reversal of 180 degrees which does not affect the cancellation process). Such a receiver will then reproduce the output from the second microphone while the conventional receiver will reproduce the output from the first microphone. The output from each receiver may be applied to a separate loud speaker and, if acoustic problems are properly solved, binaural reception will result.

The circuit of Fig. 3B shows a simple form of the phase-shifting receiver. A local oscillator is adjusted to the same frequency as the incoming carrier and is then coupled to the input from the antenna in such a manner as to tend to lock in step with the carrier at a phase displacement of a little more than 90 degrees, just enough more so that the vector sum of the oscillator output and the incoming carrier will produce a resultant carrier shifted 90 degrees from the incoming, as shown in Fig. 3A. Obviously this resultant carrier will cause the signal from sidebands 5 and 6 to be reproduced while that from 2 and 3 will be rejected.

The segregation of the two chan-

Fig. 3—Basic receiver circuit (B) with vector representation (A) of the action of the local oscillator on the resulting carrier

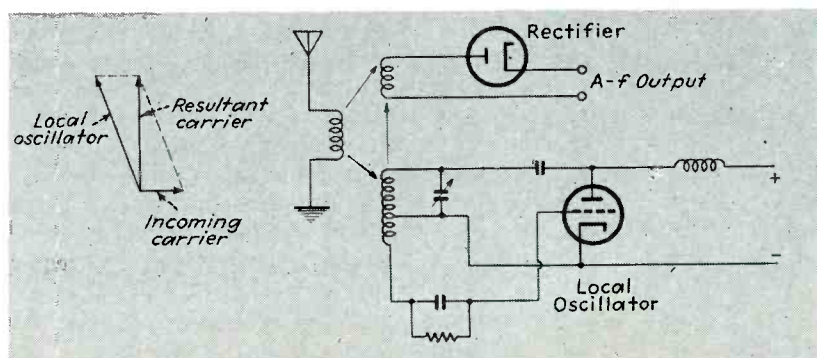

nels at the point of reception may best be performed in the output of the intermediate amplifier of a superheterodyne receiver, since the frequency of the local oscillator need not then be varied when tuning to a different station. A circuit diagram of such a receiver is shown in Fig. 4. The only extra equipment over that of a conventional receiver is the additional second detector and a-f system together with the local oscillator required for shifting the phase of the carrier. A receiver built especially for reception of binaural programs would undoubtedly contain all parts in a single cabinet except one of the speakers. This would be separately mounted for proper placement in the room when the receiver was installed. On the other hand binaural reception equipment could be added to an old receiver by providing a transmission line to be coupled to the output of the i-f amplifier. This would supply a second unit consisting of a linear detector, a-f amplifier, local oscillator and speaker for reproducing the second channel.

An experimental binaural receiver circuit used to test the system is shown in Fig. 4. The coils are coaxially wound on the same diameter. Distances d_1 , d_2 and d_3 are adjustable. Coupling d_1 is first adjusted to give the desired frequency lock-in range on the lock-in oscillator VT_2 . The value of grid leak also controls the lock-in range. Coupling d_2 is then adjusted with no incoming signal to give the correct r-f voltage on the grid leak rectifier VT_1 . This voltage should be from 3 to 10 times larger than the strongest signal which it is desired to receive. A damping resistor is inserted to make sure that the rectifier does not respond to frequency modulation directly, thereby causing some slight second harmonic distortion. This resistor will not be necessary unless the circuit has high Q . The switch S changes from frequency-modulation to amplitude modulation. When the switch is closed the receiver responds only to frequency modulation, and when it is open the receiver responds only to amplitude modulation. The input may be either radio frequency or intermediate frequency. The values of the constants given are for r-f operation in the broadcast band.

Rather crude listening tests showed that the principles as out-

lined herein are correct, and that the system is practical. As far as can be determined from these tests, the degree of separation of the two channels is quite satisfactory. However, it is difficult to make quantitative binaural measurements without an auditorium and a large number of listeners, as in the Bell System demonstrations. In place of such an investigation, another experiment was substituted which was not only easier to perform, but was also a more severe test of the ability of the proposed circuits to supply two channels for a binaural system. This demonstration was carried out at the University of Washington in collaboration with E. D. Scott, as part of a program of investigation into the general problems of frequency modulation.

In this demonstration a small transmitter was amplitude modulated in the usual manner, but frequency modulation was also applied to the oscillator unit by means of a diode-terminated transmission line as described by Eastman and Scott.³

This frequency modulation differed from that of Major Armstrong's recent work in that the frequency swing was made somewhat less than the highest audio frequency to be transmitted. Thus only the first order sidebands were of importance for high audio frequencies and the required bandwidth was not increased. At the lower audio frequencies many higher order sidebands were present, but it has been shown² that these cause no distortion. Furthermore, these higher order sidebands caused no undesired response in the amplitude-modulation receiver since they cancel in the same manner as explained before. Two separate modulations were applied simultaneously from two phonographs, one to the amplitude modulating system and the other to the frequency-modulating system.

At the receiver the two programs were separated by the method just described, and it was found that even with the crude laboratory equipment available the background sound of one program in the output of the

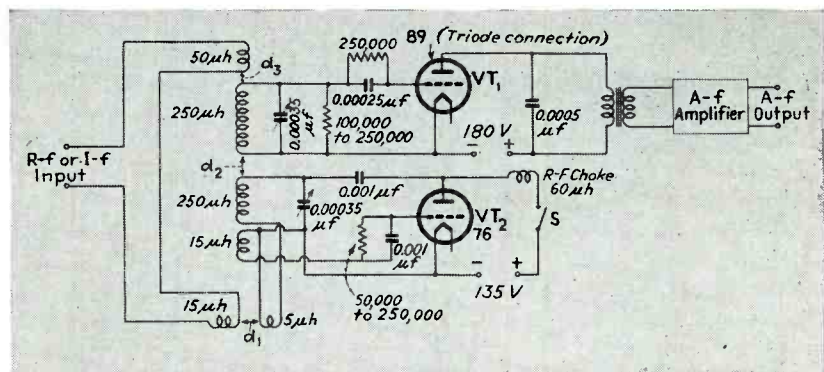

Fig. 4—Portion of a receiver, between i-f amplifier and audio amplifier, suitable either for amplitude- or frequency-modulated waves

It should be noted that the demodulator shown in Fig. 3 can be adjusted so that the diode plate current is proportional to either the instantaneous frequency deviation of the transmitter or to the instantaneous phase deviation, depending on the circuit constants of the local oscillator. In the double program demonstration described above, the output was made proportional to frequency deviation because of the method used to modulate the transmitter, while in the carrier-shifting method of approximating frequency modulation shown in Fig. 1, the output would be made proportional to phase shift.

other was more than 30 db down. While this was perhaps not sufficient separation to provide two entirely different programs with satisfactory elimination of crosstalk it would certainly be sufficient for two programs which are the same except for a slight difference in time phase.

¹ Bell Laboratories Record: June 1933, p. 286.

² J. R. Woodyard, "Application of the Auto-synchronized Oscillator to Frequency Demodulation", *Proc. I.R.E.*, May 1937, p. 612.

³ A. V. Eastman and E. D. Scott, "Transmission Lines as Frequency Modulators", *Proc. I.R.E.*, July 1934, p. 878 (vol. 22). An improved frequency modulator of the same type was described by Austin V. Eastman, "Fundamentals of Vacuum Tubes", pp. 360-362; McGraw-Hill Book Co. (1937).

Sound in Motion Pictures . . . II

Methods and apparatus used in producing present day motion picture sound are described in this second installment by Mr. Levinson. Mechanical requirements of the apparatus, advantages of ultraviolet light for recording and printing sound tracks, loudspeaker systems, and the various film stocks used in recording are discussed

ONE of the principal requirements which must be satisfied by the recording and reproducing mechanisms of a sound motion picture system is that of providing absolutely uniform motion of the film as it passes the light beam in the recorder and in the scanning beam in the reproducer. Non-uniform motion of the film in either case causes frequency modulation of the signal and is particularly objectionable during the reproduction of music or relatively long sustained tones. The frequency modulation, or "flutter," is particularly noticeable when caused by rapid acceleration and deceleration of the film. The newer recorder and reproducer drive mechanisms have been designed to eliminate this type of distortion by providing free-running film loops between the pull-down and take-up sprockets and the point of scanning. Critically damped film-driven recording and reproducing drums sup-

By NATHAN LEVINSON

Warner Brothers Pictures, Inc.

port the film at the point where it passes the recorder or reproducer light beam. Heavy flywheels are provided on both the recorder and projector motors to reduce to a minimum any variations in motor speed, and all gears employed for speed reduction purposes are carefully ground and fitted to avoid generation of speed variations by the gear mechanisms.

The recording machine designed by R.C.A. utilizes a very simple, but most effective, means of securing uniform film motion. The driving motor is coupled through gears to a magnet structure which rotates coaxially with, but independently of, a heavy fly-wheel mounted on the end of the recorder drum shaft. The magnet structure is driven at a slightly higher angular velocity than the normal velocity of the recording

drum. Eddy currents induced in the rim of the fly-wheel cause the drum shaft to rotate at such angular velocity that the peripheral velocity of the drum is just equal to the normal average film velocity through the recording machine. In normal operation of the recorder, a free-running film loop exists on either side of the recording drum, and exposure of any point on the film occurs at a point midway along the wrap of the film on the drum. This mechanism provides an extremely high degree of stabilizing action since there is no direct mechanical drive of the film at the actual point of exposure. This type of recording machine introduces the equivalent of 0.03 to 0.10 per cent modulation as compared with 0.2 to 0.7 per cent of the older machines.

The earlier printers used for producing positive sound tracks by contact printing from the negative were found to be a prolific source of both

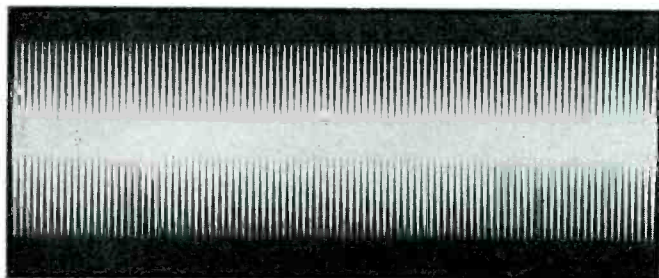

These sound track samples were produced to show the increase in detail obtained with the use of ultraviolet light as compared with incandescent light. A high audio frequency (9000 cps) was used to accentuate the difference in detail. Upper left,



a negative track recorded with ultraviolet light. Lower left, ultraviolet print of the ultraviolet negative above. Upper right, negative track recorded with incandescent light. Lower right, ultraviolet print from incandescent negative

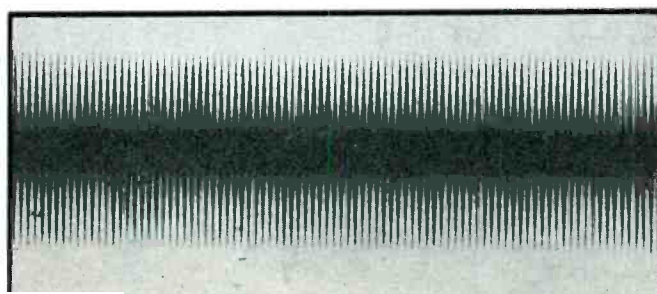
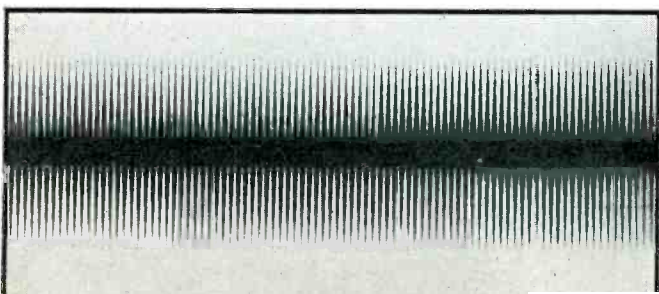

frequency and amplitude modulation. A part of the difficulty was insufficient contact between the negative and print stocks. Slippage of the positive film with respect to the negative at the instant of print exposure also contributed to the difficulty. The non-slip printer design introduced in 1936 provided a means of practically removing film slippage during the printing operation. Present day sound printers provide very positive means of maintaining an extremely high degree of contact between negative and print stocks and utilize an exposing light beam whose width is of the order of 0.005 to 0.008 inch. By restricting the length of the sound track exposed at any given instant, the effects of such slippage as may still occur is greatly minimized.

Ultraviolet Light Recording

The extension of the recorded and reproduced frequency range requires utilization of the maximum resolving power of the film. Research on methods of securing increased negative and print definition led to the introduction of a method of recording and printing which utilizes a narrow band of illumination in the near-visible ultraviolet region. When the image of a narrow slit illuminated by white light is photographed on film, microscopic inspection of the developed image reveals the fact that exposure of the film has taken place through the entire thickness of the emulsion. Scattering of the light within the emulsion and reflection of light from the film base result in a spreading of the image beyond the boundaries of the slit. If, however, the slit is illuminated with ultraviolet light and the photographic image of the slit microscopically examined, it is found that the developed image lies almost wholly on the surface of the film emulsion. This occurs because the ultraviolet light is very rapidly absorbed in passing through successive layers of the emulsion and consequently exposure of the entire emulsion depth is much less readily obtained. Correspondingly less scattering of the light within the emulsion takes place, and a very much sharper photographic image of the slit is obtained.

The change from white light to ultraviolet recording is accomplished by filtering all of the visible radi-

ation from the light source in the recorder, and using a lens system which freely transmits wavelengths as short as 3500 Angstroms. Sufficient ultraviolet radiation is obtained from the standard incandescent lamps to secure fully exposed sound track from the ultraviolet portion of the spectrum alone.

The light in the printing machines is also filtered to eliminate the visible portion of the spectrum and exposure of the print stock is obtained solely by ultraviolet light.

The application of ultraviolet light to the recording and printing processes has reduced the high frequency losses to less than 40 per cent of the values which were obtained with white light. In addition, the lower distortion resulting from improved wave form on the film has resulted in much more pleasing reproduction of high frequency sounds. The reduction of image spread obtained through the use of ultraviolet light has also made it possible to increase the density of variable area sound track prints from an average value of 1.25 to approximately 1.60. This has resulted in a somewhat lower background noise in the theater.

A very simple method of determining optimum processing conditions for variable area sound track has been devised which involves the recording of a 9000 cps signal modulated at a frequency of 400 cps. All of the 400-cps modulation is removed from the carrier signal before the test recording is made, and optimum processing is assured when no 400-cps tone is evident during reproduction of the test recording. Fundamentally, this method of testing enables such a choice of print density that the image spread occurring in the print cancels that which exists on the negative. A somewhat similar method of testing the linearity of the over-all processing of variable density sound track has been introduced by E.R.P.I.

Loudspeaker Systems

Most of the early theater speaker systems employed large horns equipped with one or more motor units behind the screen. While the efficiency of some of these speakers was reasonably high, they were deficient in both low and high frequency reproduction. One of the early attempts to overcome the de-

fects of the theater speaker, employed three speaker units: one for reproduction of the very low frequencies, one for reproduction of the middle range of frequencies, and one for the reproduction of the extremely high frequencies. Suitable dividing networks inserted between the power amplifier and speaker terminals provided proper energy distribution to the three speakers. Considerable difficulty was experienced with such systems in properly phasing and positioning the individual speakers so that uniform distribution of energy throughout the theater auditorium could be obtained. Recent developments in speaker design have given us the two-way speaker system which employs one or more dynamic speakers in suitable baffles for reproduction of all frequencies below about 300 cps, and a multi-cellular horn equipped with one or more speaker units for reproduction of all frequencies above 300 cps. This type of speaker installation has become standard in all of the studio review rooms and in all recently equipped theaters throughout the country to provide satisfactory reproduction of all frequencies between 50 and 7000 cps.

The volume range which may be obtained from a high quality variable area sound track, such as employed by Warner Bros., is of the order of 50 db. For many years it was assumed that naturalness of sound in the theater was more or less proportional to the reproduced volume range which could be secured from the sound print. It has since been found, however, that it is an easy matter to provide too great a volume range for satisfactory theater reproduction. The general noise level which exists in a theater, caused by normal audience movements, heating systems, ventilating systems, and operations in the projection booth, determine the minimum sound level necessary for a high degree of intelligibility. The type of scene portrayed on the screen and general comfort of the theater patrons, on the other hand, determine in a general way the maximum sound level which may be employed. Studies of a large number of theaters have indicated that the difference between the maximum level and the minimum level varies between 25 and 35 db. Since the volume range

existing in the original dialogue and music recorded for a picture is usually considerably in excess of 40 db, it is evident that satisfactory reproduction in a large variety of theaters can only be obtained if an arbitrary reduction in volume range is accomplished. To this end, electronic volume compressors are installed in each of the recording and rerecording channels at the studio, and are normally operated so that the original volume range of 50 db is compressed to a final volume range of the order of 30 db.

The compressors used in recording are essentially amplifiers whose gain is controlled by the instantaneous peak value of the signal passing through the amplifier. Gain control is effected by rectifying a portion of the signal current and impressing the rectified voltage on the control grids of a pair of remote cut-off amplifier tubes in the compressor units. The time constants of the rectifier circuits are so chosen that a change in gain of the compressor is accomplished in approximately one millisecond.

Films for Recording

A resume of developments in the sound recording field would be incomplete without reference to the advances made in the manufacture of film stocks for recording purposes. The early variable density sound negative records made at Warner Bros. Studio were recorded on Eastman type 1301 positive film stock with development carried to a gamma of approximately 0.4. This film was originally designed for use as a print stock, the development of which

would be carried to a gamma of 2.0 to 2.4 and was, therefore, somewhat low in sensitivity for recording purposes. In September 1932, the Eastman Kodak Company made available type 1359 recording stock which had a speed of approximately 2.5 times that of the type 1301 emulsion. This increase in film speed made it possible to reduce the recorder exciting lamp current by an amount which increased the lamp life several hundred per cent, and decreased the variation in negative sound track density which had previously been caused by lamp instability.

The 1359 type emulsion was used by Warner Bros. until the introduction of ultraviolet recording in 1936. At this time the advantages of employing variable area ultraviolet recording appeared sufficiently great to justify a complete change in plant recording equipment and the R.C.A. variable area machines were installed. At this time Eastman made available their type 1357 emulsion which had approximately twice the speed of the type 1301 emulsion to ultraviolet light and this stock is employed for sound negative at the present time.

In October 1937, Eastman type 1360 fine grain positive film was tested as a negative recording stock and found to be somewhat superior to the type 1357 film in both high frequency response and background noise. A number of productions were recorded employing this stock for the sound negative until it was determined that similar improvements could be obtained by utilizing this stock for prints employed for rerecording purposes.

In December 1939, Eastman announced the replacement of the type 1360 emulsion by the type 1361, a film of somewhat lower inherent contrast, and of such spectral sensitivity as to permit its handling under positive-type safe lights. In all other respects this film is similar to the type 1360 emulsion and results in an increased high frequency response of approximately 1.5 db at 9000 cps and a reduction in film background noise of approximately 6 db.

In order to provide negatives from which release prints can be made in the various countries, and to provide insurance against the possible destruction of the original picture and sound negatives, it is customary to prepare duplicate negatives of the picture and sound track negatives by photographic means. The process involves making a composite master print from the picture and sound negatives and by a second printing operation, secure a composite duplicate negative of the original. Until recently, the composite master print was made on Eastman type 1362 lavender stock and a "dupe" negative was made from this on Eastman type 1217 panchromatic negative stock. Prints made from the duplicate negatives, when compared with the original, showed an average increase in film background noise of approximately 5 db, a loss in volume of approximately 2 db, and a reproduction loss of 6 db at 9000 cps.

In the latter part of 1937, Eastman introduced its fine grain duplicating positive stock, type 1365, and a fine grain duplicating negative stock, type 1203. These films have been substituted for the lavender positive stock and panchromatic negative stock previously employed in making duplicate negatives and prints from this new stock show an increase in surface noise of only one db, a loss in sound level of one db, and a loss in high frequency response of only one db at 9000 cps. as compared to the original. This improvement in duplicating stocks represents a remarkable achievement in film manufacture and per-

(Continued on page 88)

Dubbing machines in the Warner Bros. Studio. Here additional sound is recorded on the film after the picture has been photographed

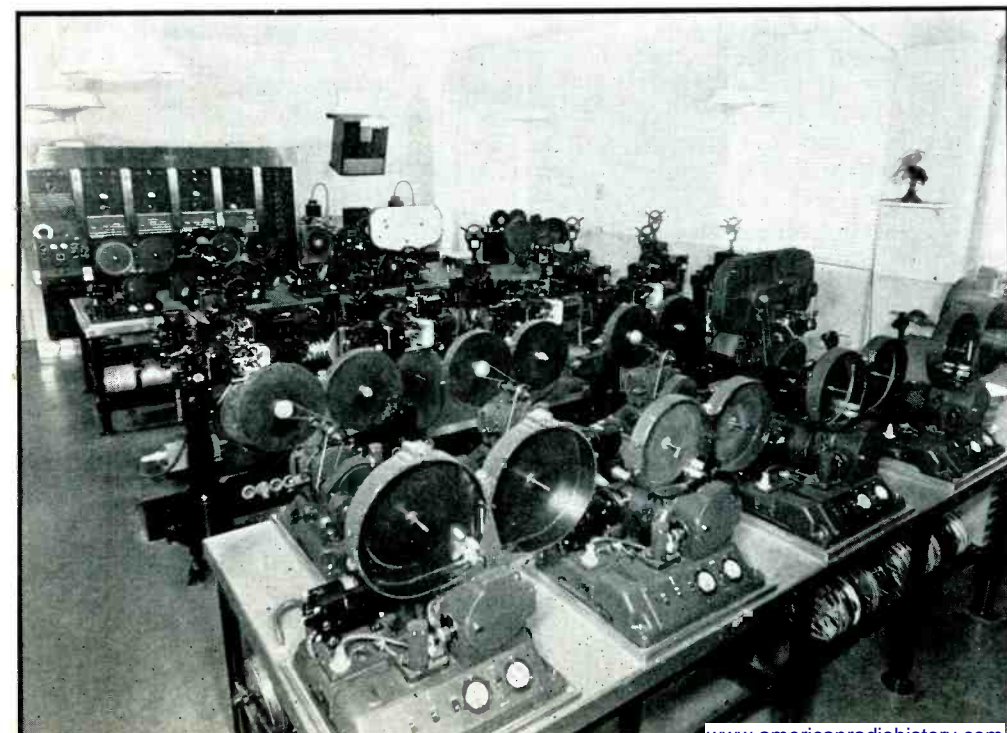

Broadcasting "On Location"

The special problems arising from broadcasting public events and how they were met by the staff of WFBL are described. A small delivery truck, a trailer, a motorboat, and even a tractor are used as a base of operations during such broadcasts

By DONALD F. LANGHAM

WFBL, Syracuse, N. Y.

300 cubic feet of space is being fully utilized and is expected to result in a compact, efficient emergency unit. However, its predecessor, a full size "Covered Wagon" trailer has seen five years of highly satisfactory service. With this unit any exigency requiring more than the usual amount of equipment could be met with a good degree of efficiency. By judicious choice of a car for hauling the trailer, space was also available for installation of equipment in the car when necessary to reach remote points inaccessible to the trailer.

In outfitting a truck or trailer, the initial move calls for careful planning on paper, with one eye to the future, before installation. How much power will we want to consume at any one time? The answer to this determines the size and capacity of the gas-driven generator. The original installation here called for an 800-watt generator since figures disclosed a tentative maximum load of 700 watts.

To make it possible to use the trailer as a studio, the generator room specifications called for good noise insulation as well as air cooling. The walls were therefore built with an air spaced double Celotex lining. Cooling is accomplished by a fan blower and grill intake system. Exhaust is carried off in the usual pipe and muffler system underneath the trailer.

In wiring, one must not overlook the following important details. Shield well so that ignition noise and a-c hum can be grounded out of receivers. Install enough outlets to more than satisfy requirements. Put in the best ground-counter

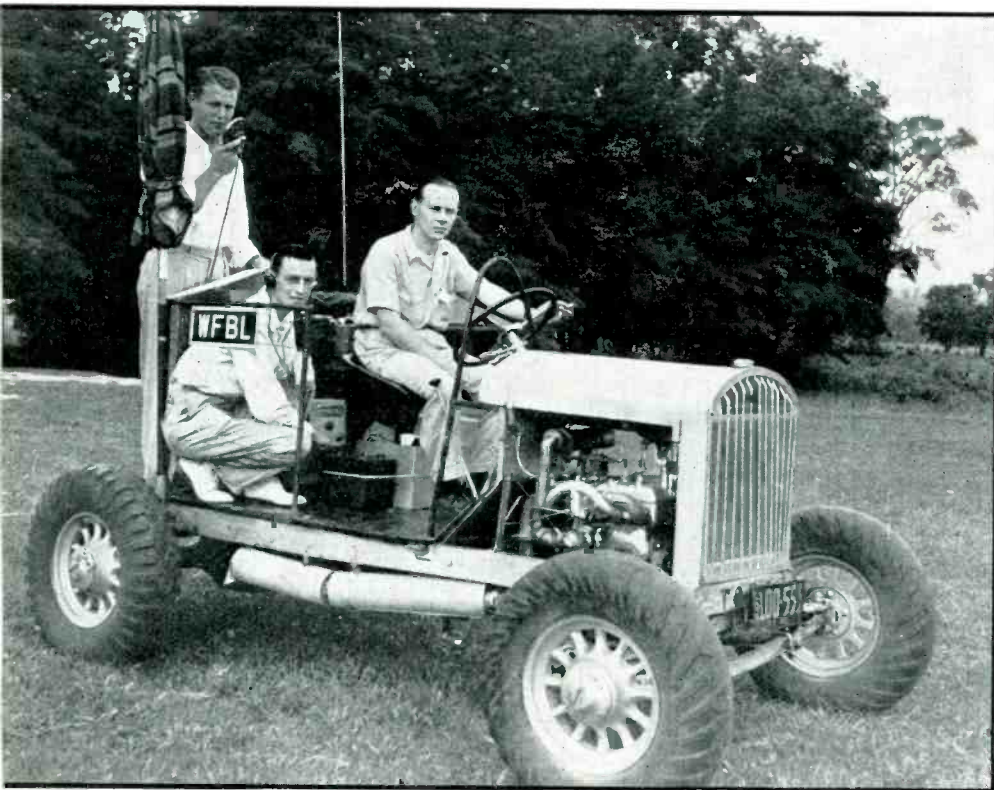

A tractor especially built for driving on golf courses was used as a traveling vantage point for broadcasting a golf tournament. A 15-watt ultrahigh-frequency transmitter is carried on the rear platform

LOOKING back over several years of special eventing by means of the high and intermediate frequencies suggested that a discussion of this phase of broadcasting might be of general interest to other harassed "brainstorm" departments, especially if applicable to the little fellow and big station alike.

There exists hardly a community which does not have its share of special and public events occurring throughout the year. Almost invariably broadcasts of such features are received with avid interest. The type and scope of field broadcasting may be of a provincial nature, but

procedure and equipment remain essentially the same.

First, what constitutes a satisfactory base of operations? Since it is for field use it must of course be a mobile vehicle, preferably large enough to allow the installation and operation of a gas-driven generator. Panel delivery trucks from three-quarter to one ton or larger are suitable in many cases. Exact specifications can hardly be suggested since each station's requirements vary according to its size, coverage and special features.

WFBL recently purchased a Chevrolet, Dubl-Duti delivery truck. Its



The top of the trailer is sometimes used for announcing where the crowds are dense or the action spread over a wide area

trailer. For instance: One yearly affair broadcast by WFBL is a 16-mile marathon race. The trailer precedes the runners, its driver guided by a communication system from the trailer. The announcer is seated at the operating position perfectly situated to view proceedings through the rear or side windows.

There is one slight disadvantage with producing programs from within the trailer. Some noise will be picked up due to the proximity of the motor-generator in spite of careful insulation. However this usually is not at all objectionable since most outdoor pickups have a potpourri of sounds as a background anyway.

The present generator is an Onan, 1000-watt unit. This unit is self starting, using push-button and battery. This comes as a distinct relief after many arduous hours of

poise screen possible underneath the chassis, bringing out connections that will be available inside and out. Make provision for removing wiring from the generator so that an outside a-c source can be used.

A spacious operating bay will pay dividends in allowing neat and efficient set-ups even when a little extra apparatus must be pressed into service. In the case of WFBL's trailer, the rear is fitted with an U-shaped operating position. This is approximately 34 inches high and 20 inches deep. Underneath both sides run cupboards and other storage space. The end is left open as foot room for the operator. The transmitter is installed on the right and the receiver in the left corner. Of these more will be said later. Other compartments include loudspeaker cubicles on either side for a PA system and bins along both sides which also serve as seats.

Good visibility from an abundance of windows and lights allows the operator to obtain cues easily or follow the progress of the program.

Then there is that program which can best be handled from within the

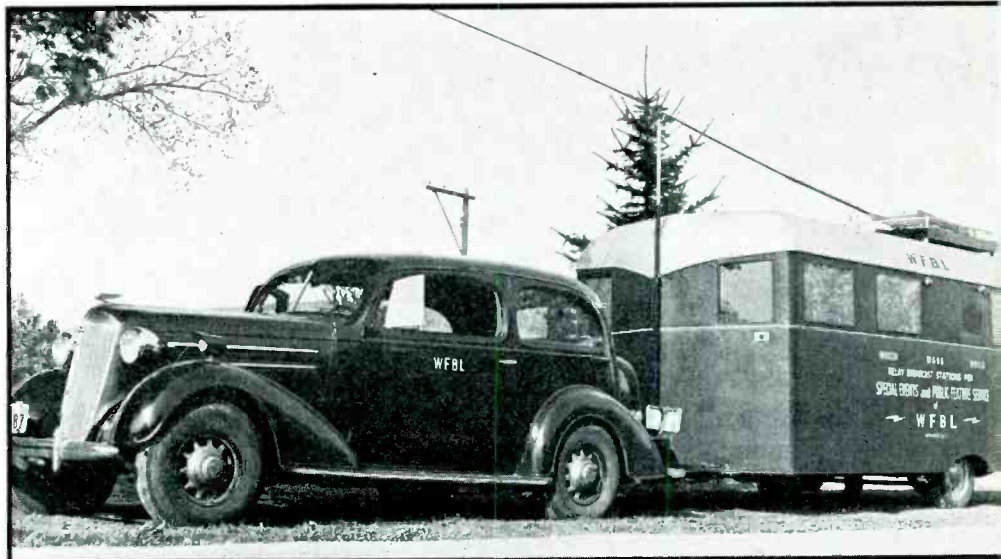

Above, the antenna is mounted on top of the trailer and need be only partially extended for short distance transmissions. Below, a 15-watt ultrahigh frequency transmitter and cue receiver in a small boat for broadcasting marine activities

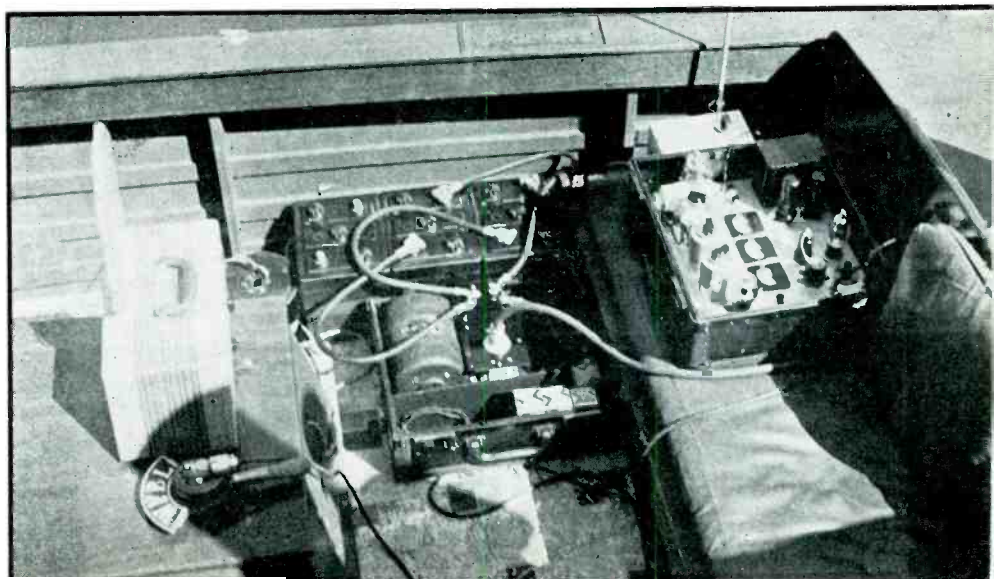

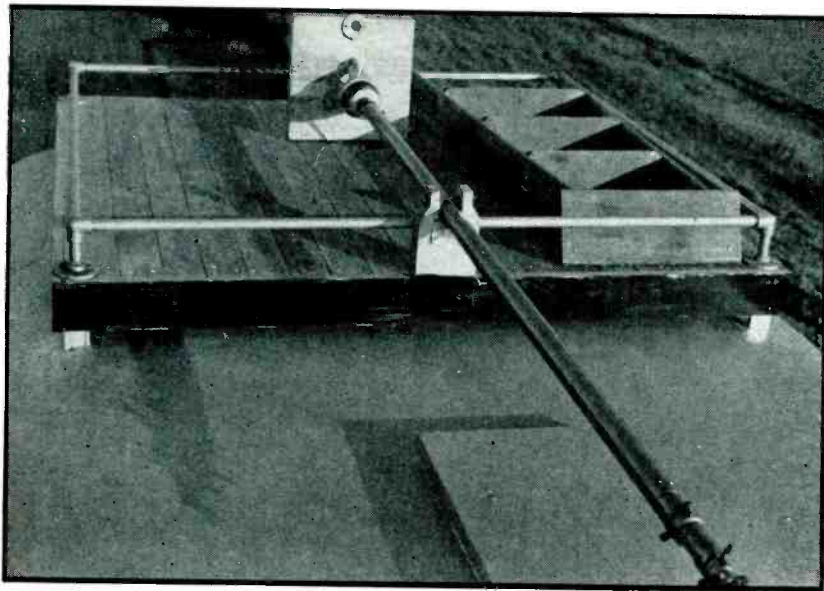

The collapsible trailer antenna is mounted on a hinged base and is shown here in the riding position. Its extended length is 35 feet and collapsed length is 7 feet. It can be set up in its transmitting position in 4 minutes

"legging" it with a non-self-starter during the cold winter months when grease and oil are like glue.

The frequencies of operation were assigned in a group around 2000 kc. Of four allocated the most widely used have been 2830 and 2190 kc. There is also a group of ultrahigh frequencies available in the vicinity of 30-40 Mc.

The first transmitter used was a Collins 45-A which is capable of 40 watts output, modulated, or 120 watts on CW. The Collins pi-net antenna matching unit accompanied the transmitter as auxiliary equipment. Airplane type mountings cushioned this double unit against vibration.

Antennas

It might be well at this point to dwell on the antenna requirements under such conditions. This is one of the most important, and yet unpredictable, phases of rebroadcast transmission, since the conditions under which each broadcast is originated are different from all others.

The antenna coupling equipment must be flexible enough to match any length of wire from 10 feet to a half wavelength. For mobile operation the antenna is limited to about the length of the trailer but often at fixed points, when the utmost in signal strength is necessary, a half-wave wire is desirable. This should either be a doublet with twisted-pair feeders or an antenna-ground system. If there is room

only for a certain length, then the matching network does the trick.

In casting about for ways of improving and speeding up the antenna installation, the vertical type was given a trial. Consequently a 35-foot Premax telescopic antenna was installed atop the trailer on a small platform. Re-enforcement of the trailer at this point became necessary to take the strain. The antenna base was hinged so that the collapsed length of 7 feet would lie along the trailer top when not in use. In this position it can also be extended to any length desired for mobile operation.

Upon arrival at the site of our broadcast the collapsed antenna is raised and bolted into position. The sections are extended and locked into place by thumb screws. Our experience has shown this can be done in approximately 4 minutes and with the related advantage of requiring no lateral area but only free space above the trailer.

Comparison tests with unloaded half-wave systems showed surprising results. Signal strengths were practically identical up to 25 miles and the vertical antenna was not quite as susceptible to selective fading. Over greater distances the longer wire showed a slight gain.

Since its installation the vertical antenna has been used on every trailer broadcast to date with excellent results. It has been worked against the counterpoise-ground screen in every case. Using chiefly

the frequencies 2830 and 2190 kc over an average distance of 5 to 10 miles and occasionally up to 25 miles or more, broadcasts have been consistently satisfactory.

Receivers

Choice of receiver to cover pickups at various frequencies and under sometimes difficult conditions, is complicated by the galaxy of equally good models on the market. The one decided upon should have good sensitivity, quality and stability. Other desirable features are variable selectivity, accurate calibration and high signal-to-noise ratio. A noise silencer that really works is a slight additional benefit, but our experience has been that few of them are actually worth their salt in work of this type.

Two such receivers are almost a necessity in all relay broadcast setups. Of course, one is required at the receiving point and the other should be permanently installed in the mobile unit. This is necessary for communication and cueing as well as monitoring. Both should be of the all-wave type and equipped with 200-500 ohm line matching outputs or accompanied by auxiliary bridging transformers.

In use at WFBL are an RME 69, a Hammarlund Super-Pro and an HQ 120. The RME is installed in a small rack along with the loudspeaker and bridging coil. This receiver has been specially rebuilt to cover 42 Mc, a handy feature when utilizing the high frequencies. It shares service in the trailer with the HQ 120. An 8-foot auto vertical serves as antenna against ground when operating mobile or over short distances.

Receiving for re-broadcasting is usually done with a half-wave doublet or good antenna-ground combination, the idea being to reduce noise level to a minimum.

These receivers are supplemented by several others which are used depending on the type of broadcast. An R.C.A. super performs at uhf when required. Two battery operated portables are also available for use in cars, boats, airplanes, etc.

A talk-back transmitter is a distinct aid in cueing and preparing for a broadcast. Installed at the receiving point and in touch with the control room it dispels any un-

(Continued on page 98)

Receiver Interference Chart

Frequencies which cause interference in a radio receiver are plotted against the tuned frequency (in the broadcast band) to show the nature of the interference and which harmonics of the interfering signal and oscillator frequencies are involved

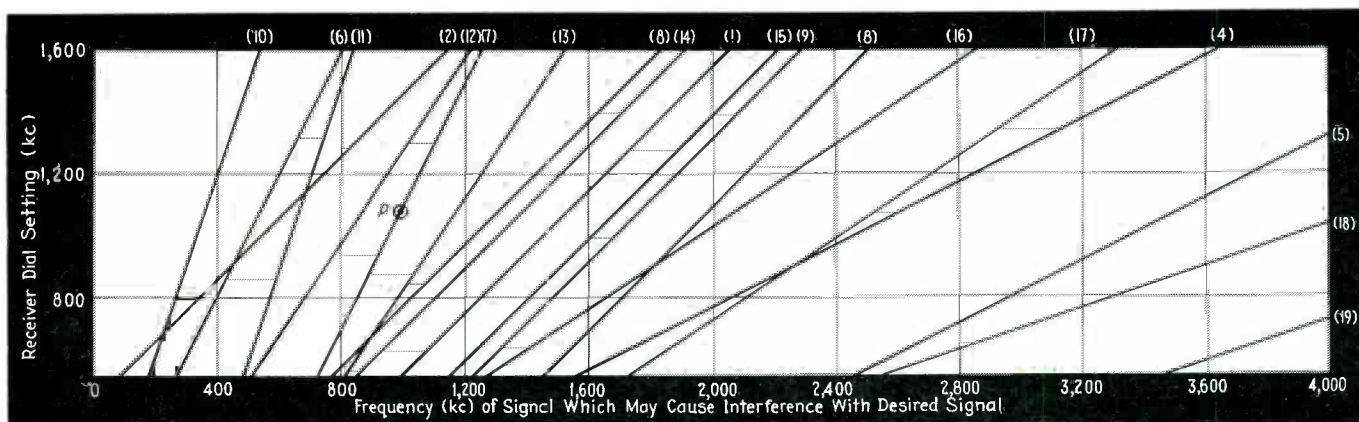

This chart indicates the types of interference which may occur at any frequency setting of a receiver, especially those receivers with two-gang tuning condensers

IN radio receivers having relatively poor preselector circuits there exists the possibility of interference from strong signals produced by one or more nearby stations. This interference is influenced by a number of factors, all having to do with the frequencies of the involved signals and the receiver oscillator frequency. If the frequency of the interfering signal is near the desired signal, it may be heard in the background or it may cause a whistle, such as the well known 10 kc heterodyne whistle. Or if the interfering signal is 5 kc from the intermediate frequency, it will result in a 5 kc whistle in the output of the receiver.

Signals of a number of different frequencies will ride through to the converter circuit where the fundamental or a harmonic will beat with the fundamental or a harmonic of the oscillator to produce the intermediate frequency of the receiver.

The different kinds of interference and their causes are generally known and the chart above provides a convenient means of determining the nature of a particular interference at any dial setting and gives a clear picture of the types of interference occurring most frequently.

BY J. J. ADAMS
Zenith Radio Corp.

The chart is based on a receiver intermediate frequency of 455 kc which has been standardized by the Radio Manufacturers Association. The equations of the curves are of the form

$$\begin{aligned}nf_s - mf_o &= f_i \\mf_o - nf_s &= f_i \\f_o - f_s &= 2f_i \\f_o - f_s &= 0\end{aligned}$$

f_s is the frequency of the interfering signal, f_o is the frequency of the receiver oscillator, f_i is the intermediate frequency, and m and n are numbers to indicate the fundamental or harmonic of the oscillator and signal frequencies, respectively, involved in the interference. All combinations of m and n of values from one to three are plotted. The curves are numbered so that the nature of the interference and the harmonics involved can be determined from the following table of equations.

- (1) $f_o - f_s = 0$
- (2) $f_o - f_s = 910$
- (3) $f_s - f_o = 455$
(image)
- (4) $2f_o - f_s = 455$
- (5) $f_s - 2f_o = 455$
- (6) $f_o - 2f_s = 455$
- (7) $2f_s - f_o = 455$
- (8) $2f_o - 2f_s = 455$
- (9) $2f_s - 2f_o = 455$
- (10) $f_o - 3f_s = 455$
- (11) $3f_s - f_o = 455$
- (12) $2f_o - 3f_s = 455$
- (13) $3f_s - 2f_o = 455$
- (14) $3f_o - 3f_s = 455$
- (15) $3f_s - 3f_o = 455$
- (16) $3f_o - 2f_s = 455$
- (17) $2f_s - 3f_o = 455$
- (18) $3f_o - f_s = 455$
- (19) $f_s - 3f_o = 455$

Example:—Consider point P on the chart. The receiver is tuned to 1080 kc as indicated on the ordinate. The point lies on an interference curve indicating that interference will occur caused by a signal of 1000 kc as indicated on the abscissa. The curve is number 7 whose equation is $2f_s - f_o = 455$. This indicates that the second harmonic of the signal is beating with the fundamental of the oscillator frequency to produce a signal of 455 kc.

TUBES AT WORK

A flexible studio console, an electronic overvoltage relay, electronic vibrato control for audio amplifiers, a phototube is used to measure vitamin A concentration and applying electronic air cleaning

A Flexible Studio Control Console

BY HAROLD KLIMPEL
KGCX

MANY AND VARIED have been the designs and construction of control consoles which have appeared in broadcast stations since the control panel has been removed from the rack position. The author was confronted with building a console which would take care of anything necessary in program production, would be easily maintained and present a neat appearance. The result is the unit pictured with explanation of the schematic diagram of the circuits used. Nothing is new to the trade although several advantages are incorporated which were deemed advisable, some of which are not found even in factory built assemblies.

The cabinet itself was built of oak. It is 4 inches deep on top which discourages using the top as a shelf. The bottom was left open which places almost all equipment within easy reach for maintenance. The panel itself is sloping at a 60-deg. angle and can be removed from the cabinet if it is necessary to get at the uppermost items. It is only necessary to tip the cabinet on its back which places the attenuators in an easy position for cleaning.

The panel is of aluminum material 8½x30 inches, laid out to place controls most used within easy reach of the operator without having to use the elbow for resting purposes. All pads are lined up as a "straight six" with the two master gain controls directly below the Weston VU meter which is continually across the line. No provision was made for changing reading level of meter as normally a given input is fed to program line and eliminates trouble due to change in levels. The meter is compensated to read 8 VU across 600 ohms. A 6 db 500-600 ohm pad was inserted to change output impedance of amplifier to 600 ohms out and provide line isolation. Above each channel attenuator there are two keys, the lower in each case being used for program circuit while the upper keys are used to switch respective source into audition channel. This arrangement does not tie up any source for any purpose as one input on any channel may be used for program circuit while the other source is being audi-

tioned. Several consoles switch a source into either of two loads while the other source cannot be used at that time. The circuit at KGCX allows using as many as eight inputs. At KGCX, turntables are run through Western Electric control cabinet and amplifier and thus take up only one channel. There are five inputs available for microphones and two channels wired for remote lines. Each remote channel will take care of eleven lines which are selected by means of rotary selector switches mounted on each side of the VU meter. Referring to the circuit it will be seen that the output of the selector switch feeds the lines into a matching transformer which balances the lines to ground and changes to mixer impedance on the secondary. The headphone jack directly below each selector switch permits monitoring of the selected line or with a plug-in level indicator allows measuring the incoming line level. The keys below the jacks are used in all

three positions to allow talk-back to line by means of the transmitter-studio interphone, sending cue from radio monitor to selected line and to put the remote on either audition or program channel. In either talk-back or air position a relay removes the cue signal from the line. It is to be noted that one remote can be carried on the program channel while the other remote channel can be used for audition or cueing for a succeeding remote. This is something that cannot be done with several consoles which have provisions for only one channel for remotes. The remote system is foolproof and does not present any difficulties to the non-technical operator. A remote channel can be turned on and gain control advanced to normal position with line key in cue position awaiting standby and the only thing that need be done to put remote on air is to throw key to air position. The line keys were wired so that the corresponding channel key would be thrown in the same direction for "air" operation. Otherwise these two keys would be thrown toward each other and be quite close together. At this station the two inside channels were wired for use with microphones which are thrown on by placing switch toward the meter. Throwing switches on these two channels away from meter would put them in the "line" position. No trouble has been experienced from this source even though the board is not engraved or labeled.

Between channels 1 and 2 as well as between 3 and 4 there are three push-button keys. The two lower keys are used to activate relays for turning on the turntable motors while the middle

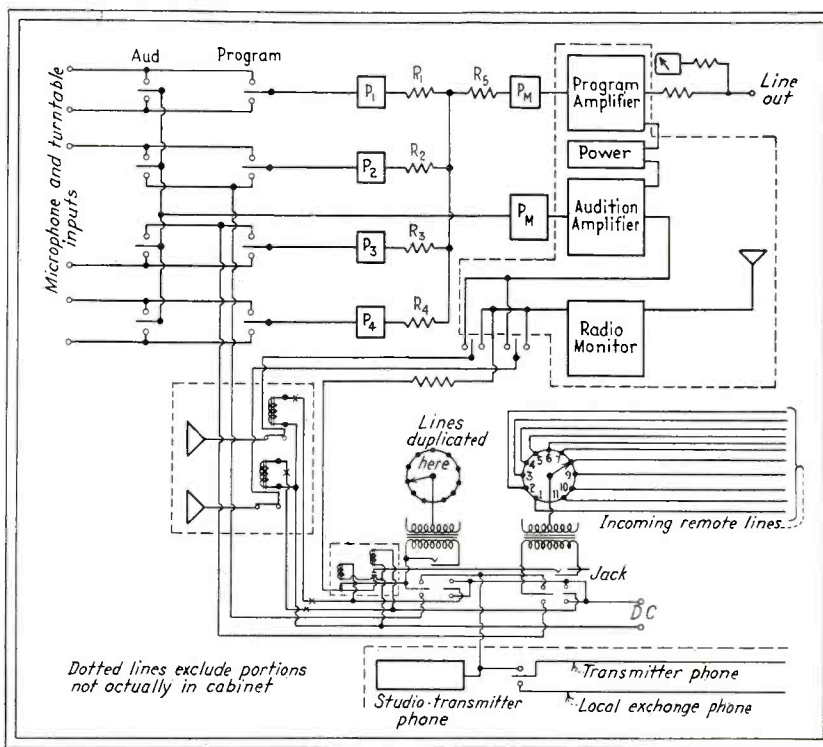

Block diagram of a flexible studio control console

CINCH MOLDDED SOCKETS
TO FIT THE NEED

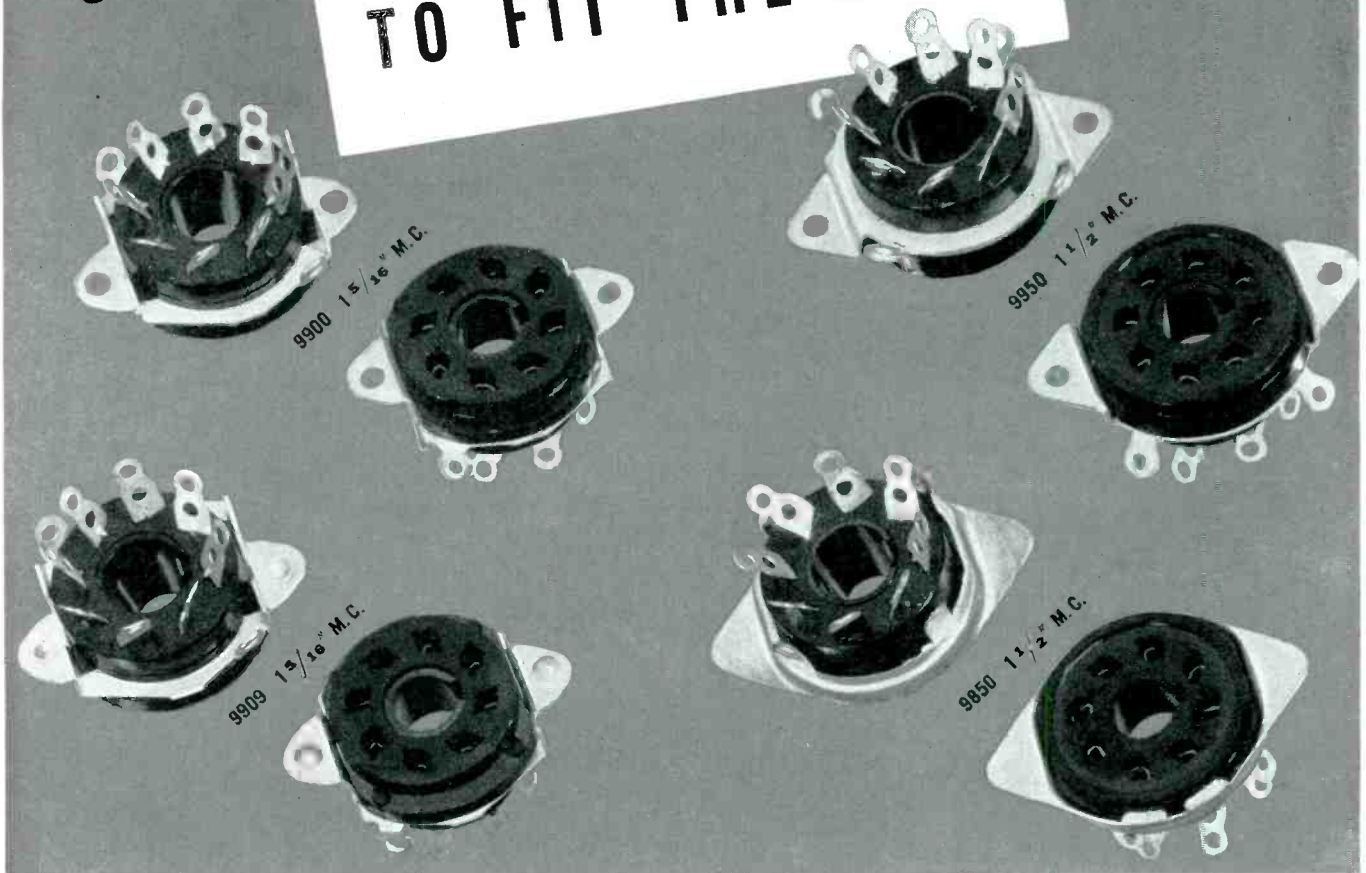

WHEN the preference is...Molded sockets, the choice should be "CINCH"...Supplied with saddles for customary riveting to chassis...and also for spot welding... Embodied in these sockets are all the CINCH distinctive features; CINCH solder coating... positive contact, floating type... and the best material and workmanship.

CINCH Molded Octal Sockets are licensed under American Phenolic Corp. patents.



SUBSIDIARY OF UNITED-CARR FASTENER CORP., CAMBRIDGE, MASS.

MANUFACTURING CORPORATION

2335 WEST VAN BUREN STREET, CHICAGO, ILLINOIS



IT'S
Safe
WHEN IT'S
TURBO
VARNISHED TUBING
SATURATED SLEEVING

SAFE against cracking — because of flexibly-constituted linseed-oil base varnishes — safe against moisture absorption — attested by recent independent laboratory comparative tests — And safest in all those applications demanding an extra-measure of safety in dielectric values.

TURBO isn't layer film insulation — it's impregnated — thorough saturation down to the very base of the cotton — even inside too — in order to facilitate snaking and fishing operations on the assembly line.

Electrically and physically your safest tubular insulation bet.

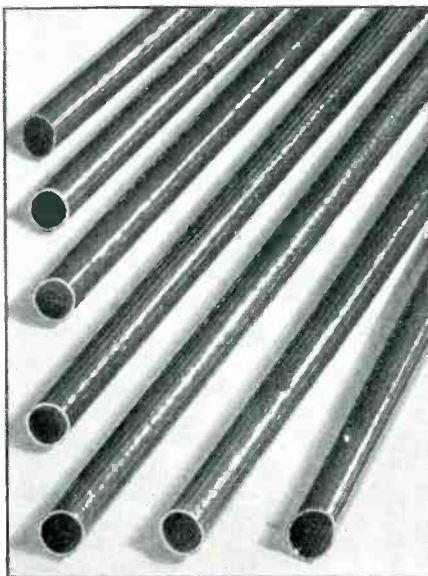

● Judge for yourself from our new sample board now awaiting your request

WILLIAM BRAND & COMPANY

Block Mica, Mica Plate and products—Varnished oil tubing, Saturated Sleaving, Varnished Cambric, Cloths and Composites

276 FOURTH AVE., NEW YORK, N. Y.

217 NO. DESPLAINES ST., CHICAGO, ILL.

pair, colored red, is used to turn off the respective motors. The uppermost pair of keys are used in the monitor system. By referring to the schematic, it will be seen that input to the monitor speakers are fed through double throw switches which select power from either the audition amplifier or the radio monitor. These two pushbuttons are of the locking variety while the other motor buttons are not. In stations where a more elaborate system of controlling speakers is desired a larger number of keys could be so mounted. This arrangement places all controls at the operating desk by means of which the engineer can take care of anything from putting a program on

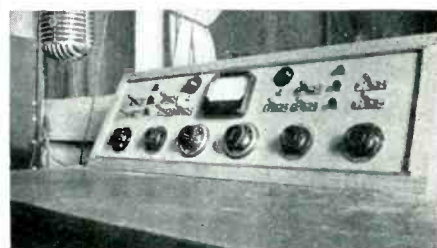

Control panel of the console showing 6 volume controls in a line

the line to carrying on studio auditions and talk-back or checking with remotes. It will also be noted that no separate mike is necessary for talk-back to studio during rehearsals or auditions. The announce mike key for audition must be merely thrown with the studio speaker key in audition position and conversation can be carried on with studio. With ordinary care no trouble should be experienced in getting talk-back on the air. However, the attenuator for the channels in use for audition can be returned to maximum attenuation which will prevent accidental hitting of the program key. One advantage of the console described is that it allows a flexibility of control and use that some consoles don't go in for. For instance, a studio program may be carried on from one channel while the other source of the same channel may be used for audition or checking.

A change that could be made in the cue for lines is the use of a selector switch to take output from either radio monitor or the audition amplifier. This would allow using the announce mike to talk to a remote pickup. However, with the telephone being used in this place, it was not deemed necessary. The only other thing a remote needs is a station cue which can be taken directly off the radio monitor through a pad to reduce output to suitable level to feed the line.

For the smaller stations where the operating point prior to feeding the transmitter is not a master control room, the unit described above seems to be about the ideal from the standpoint of being less complicated, involving less equipment and taking care of anything necessary to prepare a broad-



“What’s wrong with this picture?”

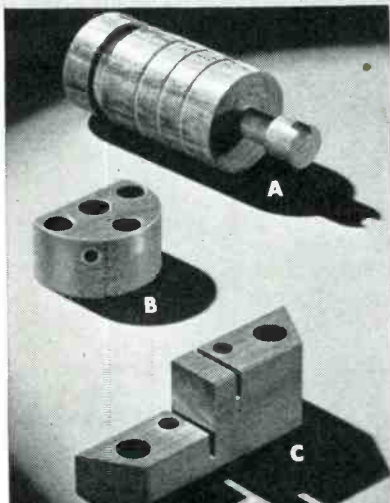

A—Air-brake piston—drilled, turned and grooved on lathe, and milled.

B—Band sawed, lathe turned, drilled and counterbored insulator.

C—Sawed, milled, drilled and counterbored insulator.

THERE'S nothing wrong with this picture except that it doesn't show the alarm system which already has a riot car on the way to the scene. Neither does it show that Synthane insulation is quietly but dependably on the job all the way from the signal button to the enunciator at headquarters. Or that Synthane supplies reliable insulation to manufacturers of burglar, smoke, fire, water and many other alarm systems.

Although alarm systems may have no bearing on your business, Synthane can probably help you, for Synthane Bakelite-laminated sheets, rods, tubes and fabricated parts influence the design, production and performance of many electrical, radio, mechanical and chemical products.

Synthane is a dense, hard, uniform technical plastic with a plus of *combined* properties—light-weight (half the weight of aluminum), structural strength, excellent dielectric characteristics, resistant to many corrosive solvents, gases, petroleum products, water and many acids and salts.

Synthane is also easily machined. You can machine it yourself or we'll do it for you as we did for three typical manufacturers whose products are pictured at the left.

If you want to improve performance, lower costs, or smooth out production problems, write for samples of Synthane, information or engineering assistance.

SYNTHANE CORPORATION, OAKS, PENNSYLVANIA

SYNTHANE
Bakelite— laminated

TECHNICAL PLASTICS

SHEETS • RODS • TUBES • FABRICATED PARTS • SILENT STABILIZED GEAR MATERIAL

a "microscope" for the hard-of-hearing

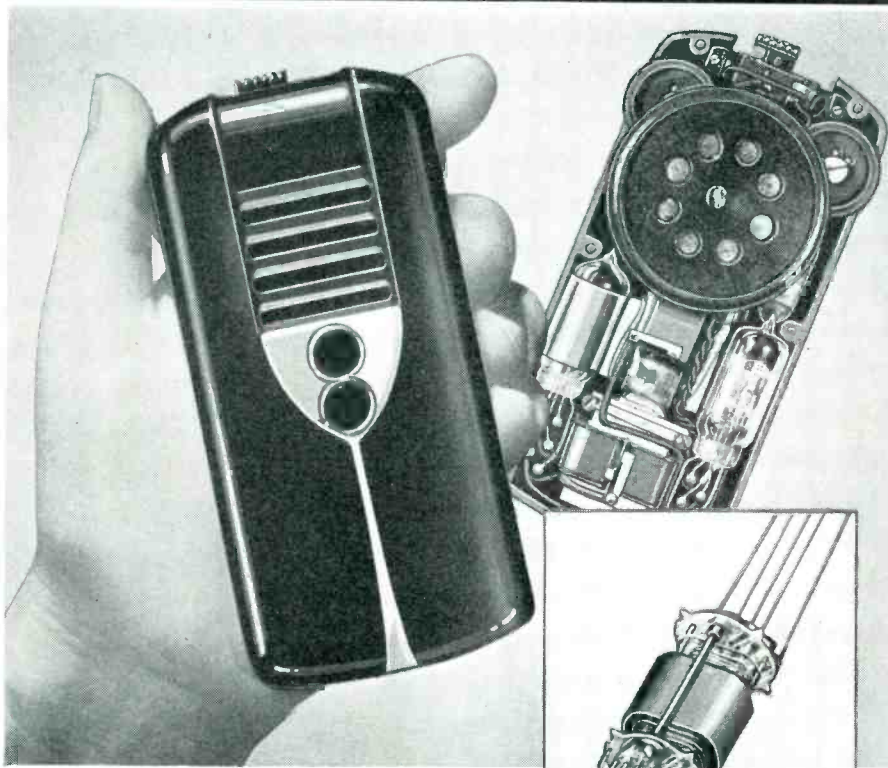

a **SONOTONE** development
to which **CALLITE** contributed

This **SONOTONE** hearing-aid, with its bone conduction oscillator or midget earpiece, gives an acoustic output of 100 db. in a device so small it fits into a vest pocket. Designing a complete 2-tube amplifier and its associated microphone for such limited space presented a unique problem. **SONOTONE** Research Laboratories solved it by developing special tubes which combine high-gain with ultra compactness.

To build such efficiency into tubes so small required skill in designing and meticulous choice of materials—particularly for the miniature tube grids. Logically, Callite Calmolloy wire was chosen for this hypercritical job—because of its uniformly excellent working characteristics and complete freedom from oxidation.

Calmolloy wire is one of a large family of specialized Callite products for vacuum tube manufacture, which includes grids, plates, lead-in wires, filaments and formed parts—all products of careful Callite research in the application of tungsten, molybdenum and special alloys to modern vacuum tube design. Perhaps you have a difficult vacuum tube problem. Callite's research staff is at your disposal.

MANUFACTURERS OF electrical contacts of refractory and precious metals, bi-metals, lead-in wires, filaments and grids—formed parts and raw materials for all electronic applications.

CALLITE TUNGSTEN CORPORATION

544 - 39th STREET

CABLE:



UNION CITY, N. J.

"CALLITES"

BRANCHES: CHICAGO • CLEVELAND

cast for the air. A careful study was made of all factory built assemblies as well as articles appearing in **ELECTRONICS** on several sets of studio speech input jobs. The final circuits and method of assembly was decided upon after weighing all of them against what was wanted for that job at hand. Most all of the ideas incorporated appear in some or the other of various pieces of equipment although the author has not, as yet, seen them all assembled into a single unit. It is hoped that some of the ideas expressed may be of help to others who are called upon to design a flexible studio control console.

• • •

An Electronic Overvoltage Relay

By G. G. KRETSCHMAR
Walla Walla College

A USEFUL AND SIMPLE RELAY for the protection of a-c equipment from dangerously high voltage may be assembled by making use of the type 885 grid-controlled rectifier with some accessory equipment. The diagram shows the circuit arrangement. S_1 is an electromagnetic relay. A small G.M. type D with a 110-volt coil was used in this setup. The coil is energized by the output of the 885 tube as shown. A

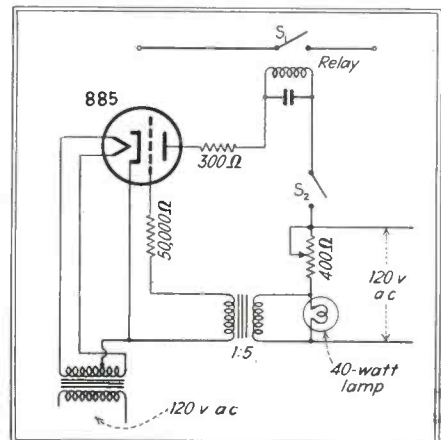

Circuit of electronic
overvoltage relay

large capacity across the relay coil is necessary because of the operation with pulsating direct current from the tube. The switch S_2 controls the operation. When it is thrown in, the output of the tube passes through the relay coil, thus holding the armature in contact and making the connection in the circuit which is being controlled. Any interruption of the relay current will permit the relay to open and thus interrupt the circuit of which the relay switch S_1 is a part.

To operate the device as an overvoltage relay, the a-c line is connected across a small 400-ohm rheostat in series with a 40 watt mazda lamp. The secondary terminals of the grid transformer are connected across the terminals of the lamp. In using the



ONLY AN EXPERT can distinguish shatterproof glass from the ordinary. Capacitors, too, look alike. But what a difference in performance. That's why it pays to get the "inside story". It's the hidden qualities that determine capacitor stamina.

EXTRA STAMINA!

The big difference...

HIDDEN IN THE CAPACITOR INGREDIENTS —
THE SECRET OF C-D's EXTRA PERFORMANCE

IT'S that extra measure of stamina built into Cornell-Dubilier capacitors that wins the engineer. You'll discover it hidden in the ingredients—the big difference between C-Ds and capacitors that "look just like" C-Ds. For these ingredients—in their extra quality and experienced assembly—reveal the secret of Cornell-Dubilier's surviving soundness. You won't find such extra performance every day, because Cornell-Dubilier's 31 years of capacitor specialization is unique. You will find, though, that there are more Cornell-Dubilier capacitors in use today than any other make!

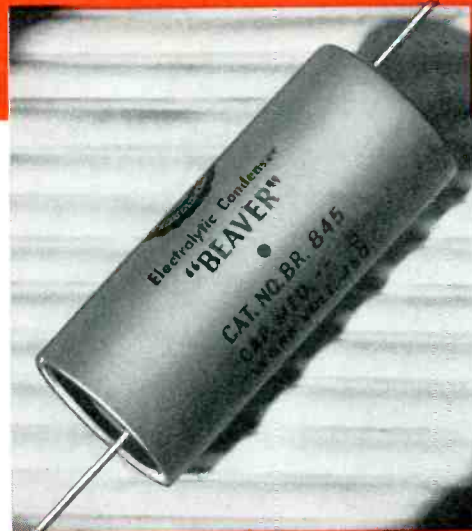

Only Cornell-Dubilier Electrolytics offer all these EXTRA FEATURES!

- Special high voltage paper separator
- C-D etched plate
- Special C-D electrolyte
- Special high formation process

★

For complete technical information, write for engineering bulletin 170

**CORNELL-DUBILIER
ELECTRIC CORPORATION**

1006 HAMILTON BLVD. • SO. PLAINFIELD, N. J.

REMEMBER! Only C-D union-made capacitors give you the EXTRAS at no extra cost.

Get the extras

— WITH CORNELL-DUBILIER CAPACITORS!

FROM  **EARPHONE DAYS TO... NOW!**

complete

**WESTINGHOUSE STATION NO. 1
WAS KDKA IN PITTSBURGH**

Its broadcast of the Harding-Cox election returns established a milestone in radio history. Since that date Westinghouse has been engaged continuously in broadcast operation—and this commercial operating experience is reflected in all the equipment which Westinghouse makes for radio stations, including equipment for antenna phasing, antenna tuning, antenna lighting, main power entrance, power transfer, generation, distribution, station lighting, power control, and operating consoles.

Back in the days when a crystal detector and a headset marked the rabid radio fan, the first regularly scheduled broadcasts came over the air from Westinghouse station KDKA. Leadership *then* built the foundation for leadership *today*.

In operating experience that early nucleus expanded to include WBZ, WBZA, KYW, WPIT, WBOS, WOWO, and WGL.

In manufacturing experience it spread over the entire field of equipment for commercial broadcasting to include that last word in modern radio transmission — the new Westinghouse 50-HG transmitter. Today Westinghouse is the **ONLY** company which manufactures under its own name and responsibility **ALL** the equipment needed for complete radio transmitting station operation.

First-hand experience and familiarity with commercial station requirements guide every step in the design and manufacture of this equipment. Westinghouse knows the problems of the commercial station operator because Westinghouse **IS** a commercial station operator.

If you anticipate replacement or expansion of your present broadcast equipment, talk to a Westinghouse man.

**COMPLETE SUPPLEMENTARY
EQUIPMENT AND SERVICES**

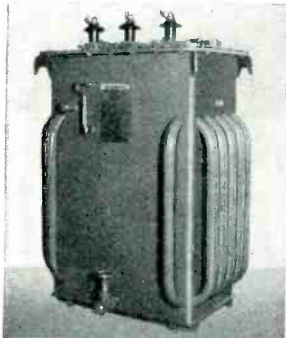

Transformers

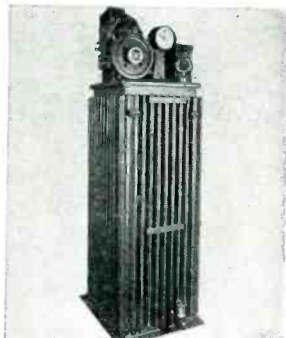

Regulators

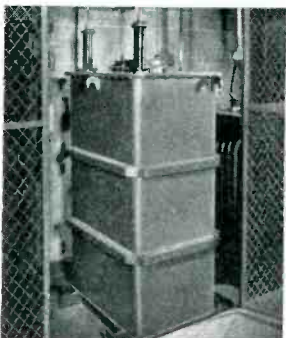

Reactors



Circuit Breakers



Westinghouse

Equipment

FOR COMMERCIAL BROADCASTING

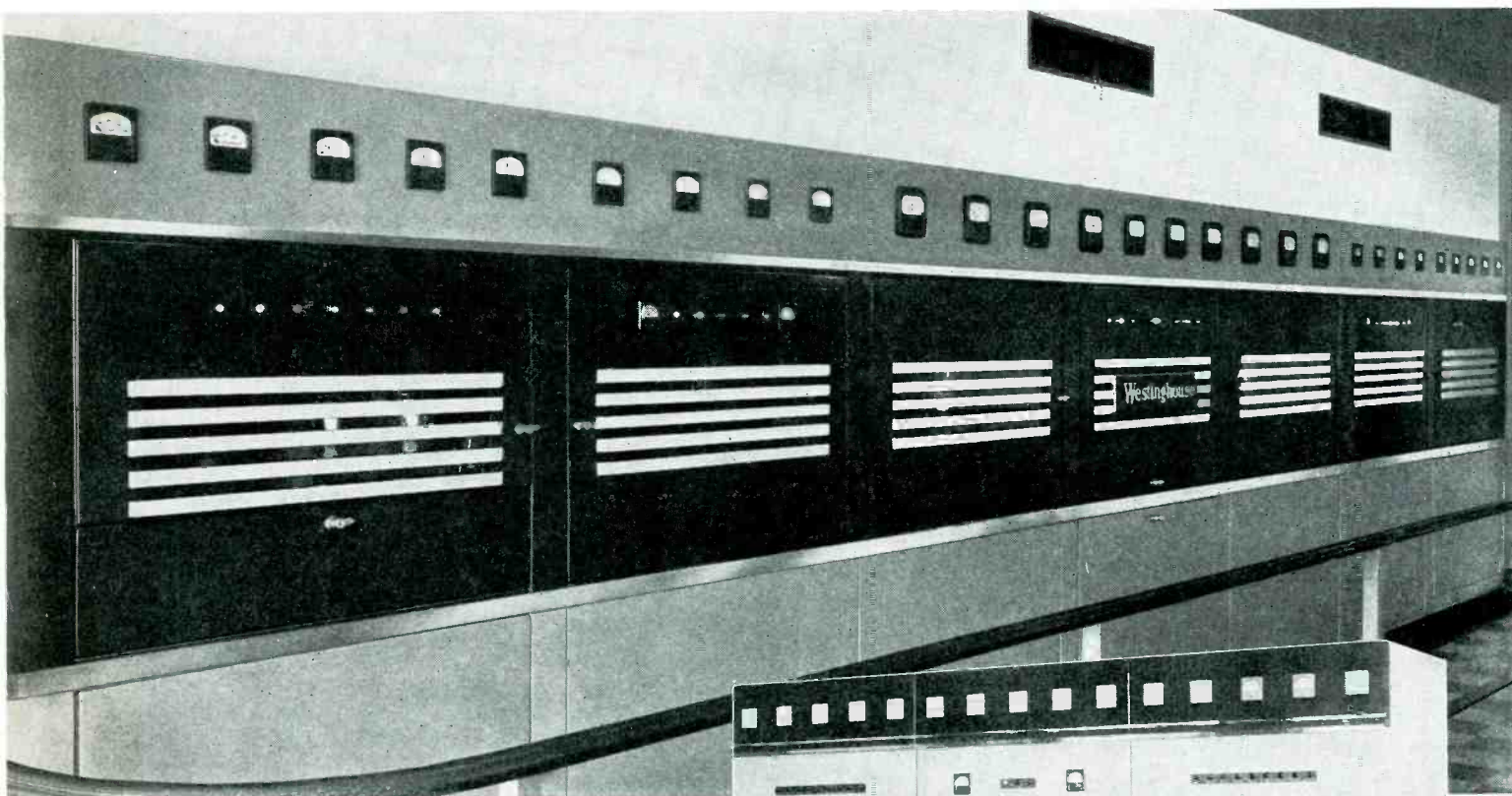

50,000 Watts . . . with air-cooled tubes in all stages, metal rectifiers throughout except main high-voltage rectifier, equalized feedback, compressed gas condensers, complete elimination of fuses, full automatic control and other improvements characterize the new Westinghouse 50-HG Transmitter now in use or being installed by Stations KDKA, WBZ, WPTF, and WBAL.

5,000 and 10,000 Watts . . . the new Westinghouse 5-HV and 10-HV Broadcast Transmitters include the advantages of air-cooled tubes in all stages, metal rectifiers for all low-voltage plate supply, inductive neutralization of the power amplifier, equalized feedback, and compressed gas condensers.

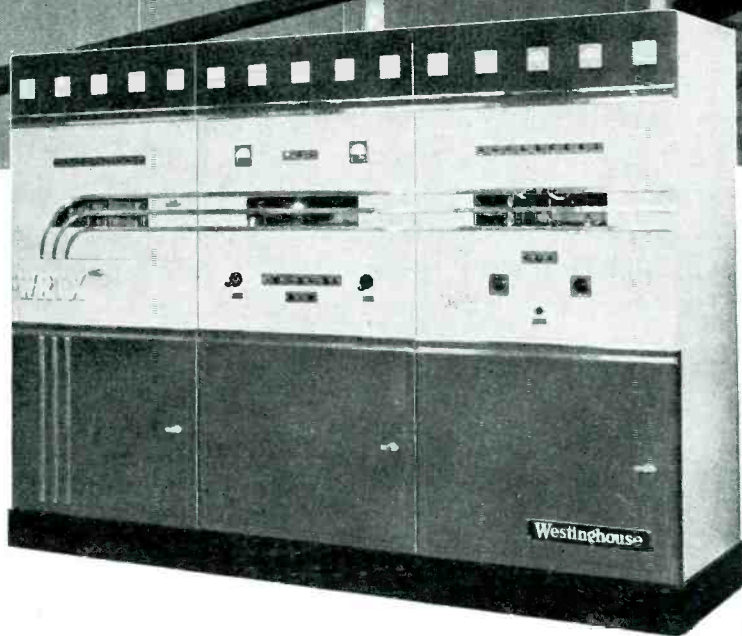

J-08032

Broadcast Equipment

ASTATIC LOW PRESSURE CRYSTAL PICKUP

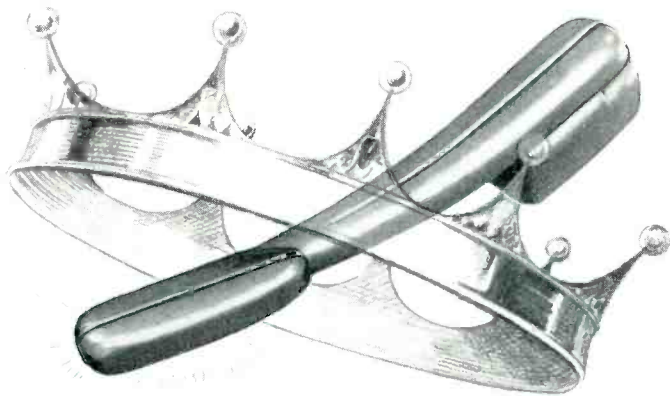

ANOTHER CROWNING ACHIEVEMENT OF ASTATIC LABORATORY

● Introduction of this Astatic Low Pressure Crystal Pickup with built-in, permanent sapphire point, has brought about finer quality phonograph reproduction, eliminated practically all wear on records and dispensed with the necessity for changing needles. While the principles involved were not new to the industry, it remained for Astatic Engineers to envisage the possibilities of a low pressure pickup arm and develop it for practical use at nominal cost.

So it is that Astatic's Low Pressure Pickup with rounded jewel point that glides smoothly over the record with featherweight, one-ounce pressure, brings tomorrow's phonograph reproduction today. Leading manufacturers of quality phonographs have been quick to see the advantages of low pressure pickups and many new models will soon appear on the market with this modern pickup arm.

Astatic literature, explaining the technical construction as well as the advantages of low pressure crystal pickups, is available upon request.

In Canada: Canadian
Astatic, Ltd., Toronto, Ont.

Astatic Crystal Products
Licensed Under Brush
Development Co. Patents

ASTATIC

ASTATIC MICROPHONE LABORATORY, Inc.
YOUNGSTOWN, OHIO

tungsten filament lamp in this way use is made of the rising temperature resistance characteristic of the lamp. The operating point is set by means of the rheostat to a pre-determined tripping point somewhat higher than the normal line voltage. If then, for any reason the voltage of the line rises to this point, the grid voltage will rise to the cutoff point of the tube and the plate current will stop, thus releasing the relay switch S_1 .

It is also possible to operate the circuit so as to protect for low voltage. To do this the switch S_2 should be of the magnetic type with the coil so adjusted that the switch will spring open when the voltage falls to some pre-determined value lower than the normal line voltage.

• • •

Electronic Vibrato Control For Amplifiers

BY BERNARD EPHRAIM
Represa, California

THE RICH TREMULANT EFFECT called the vibrato so necessary to the character and brilliancy of music can be reproduced electronically wherever music is amplified. The vibrato described here is not an ordinary type of volume tremulant in which the gain of an amplifier is made to vary at some fixed cyclic rate or where the volume at the output controls the amount of gain of some low-level stage without reference to the amplitude of the modulating tremulant voltage.

The circuit generates a low-frequency volume variant in the form of a compressing bias voltage which is injected into the grid circuit input to decrease the gain in that stage. The value of the amplitude of the injected voltage is proportional to the volume variation at the power amplifier output. A means is provided for the user to vary continuously both the depth and frequency of the vibrator over a wide range.

The simple circuit shown in the accompanying figure consists of an ordinary power amplifier together with the auxiliary vibrato circuit. Tube T-1, a 6V6GT, is utilized as a low frequency oscillator, the period of oscillation being governed by the RC elements in the grid circuit. The oscillation frequency can be made to vary from 200 to 900 cycles per minute by tuning the variable condenser assembly. The output of the oscillator is capacitively coupled into the first section of tube T-2 which functions as an ordinary amplifier. The output of the amplifier is capacitively coupled into the second section of this same tube which functions as an expanding amplifier directly controlling the amplified amplitude of the generated oscillations. The negative grid bias required to control the gain of the expanding amplifier is furnished by the first diode section of tube T-3. This diode is sup-

For Constant Line Voltage Regulation



No Tubes..

No Maintenance..

No Moving Parts..

THE CLARK BULLETIN 4000 Autovolt is an Automatic Line Voltage Regulator which maintains the Load Voltage within plus or minus $\frac{1}{2}$ of 1% for load variations from zero to full capacity of the regulator. This regulation is maintained regardless of the power factor of the load.

Standard models will handle a line voltage variation of approximately 10%.

These Clark Autovolt Regulators have been in successful operation for several years in such applications as Laboratory Testing, Radio Tube Testing, Incandescent Lamp Testing, Electric Meter Calibration, X-Ray Therapy, Sound Recording Studios, and Fractional Horsepower Motor Testing.

The efficiency of these Regulators is up to 95%, depending on the size and loading of the Regulators.

They are offered in a full range of sizes up to and including 8.64 KVA, single phase, 60 cycles.

Size 1—carries 10 amperes connected load at 110 Volts

Size 2—carries 25 amperes connected load at 110 Volts

Size 3—carries 50 amperes connected load at 110 Volts

Size 4—carries 75 amperes connected load at 110 Volts

Also supplied for 220 Volts, with the same KVA ratings as above.

These Regulators introduce negligible phase shift between voltage and current, thus minimizing added reactive KVA.

Wave form shows no appreciable distortion—under very adverse conditions a total of 8% or less.

Output voltage can be adjusted continuously over 15% band under load, without opening circuit or disturbing regulation.

Your inquiries for Line Voltage Regulation will receive prompt attention.

WRITE FOR FULLY DESCRIPTIVE FOLDER

OFFICES IN PRINCIPAL CITIES



THE CLARK CONTROLLER CO.



1146 EAST 152ND ST.

CLEVELAND, OHIO

WE SPECIALIZE IN

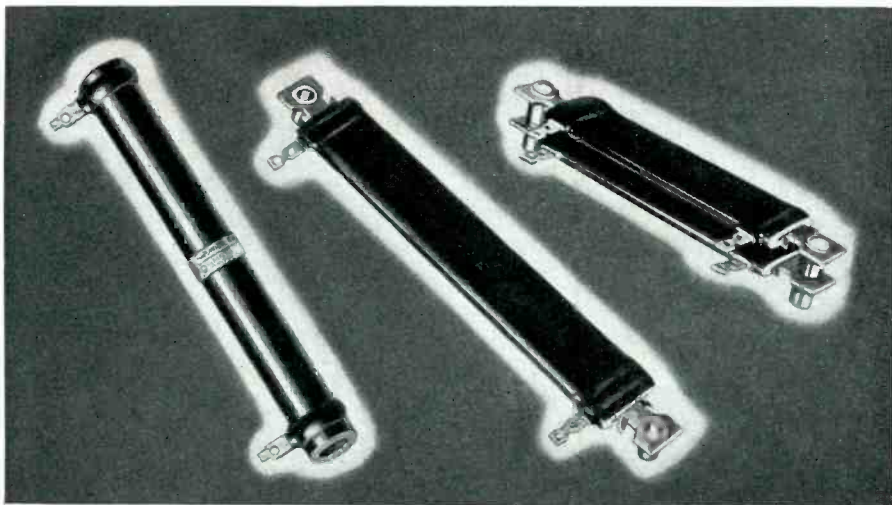

RESISTANCE PROBLEMS

...From Our New, Compact Blue Ribbon Resistor to the Largest Custom-made Job...

Exclusive features of our flat Blue Ribbon resistor—extreme compactness, greater capacity and ease of mounting.

Vitreous enameled resistors and rheostats—over 100 standard resistor sizes ranging from 4 to 400 watts—standard rheostats from 10 to 500 watts—all available with a diversity of terminals, mountings, etc.—thus enabling us to make quick delivery of your needs whether they be standard or special.

During our 16 years' experience in the development, manufacture and application of resistance devices, valuable knowledge has been attained—our engineering co-operation is at your command.



May we consult with you on your next order?

HARDWICK, HINDLE • Inc.

NEWARK, N. J., U. S. A.

Resistors • Rheostats • Radio Frequency Reactors
Power Line Chokes • Line Voltage Reducers
Custom-made resistance devices of all types

plied with an audio-frequency voltage taken from one of the plates at the output of the power amplifier by means of condenser C_8 . This rectified voltage is partially filtered to prevent any audio-frequencies from feeding back.

For any increase in the output voltage at the power amplifier, there will be a corresponding increase in the rectified voltage from the 6H6 diode rectifier; this in turn increases the gain of the expanding amplifier and that of the amplitude of the oscillatory voltage in that circuit. It is essential that the low-frequency oscillation amplitude be controlled to secure the real organ vibrato effect.

The output voltage from the expanding amplifier is capacitively coupled into the second diode section of tube T-3. This rectified voltage is filtered and no special time constant need be

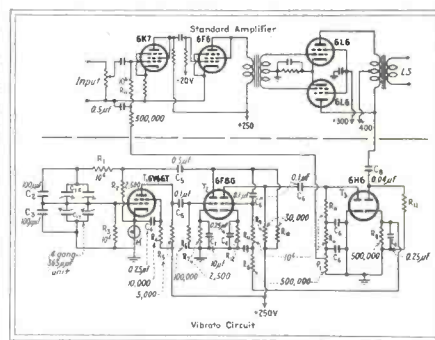

Circuit of vibrato control

given to this part of the circuit configuration other than that the time value be considerably less than the lowest frequency of the oscillator. The pulsating direct-current voltage from rectifier 6H6 is injected into the first tube in the power amplifier to decrease or rather compress the gain in cyclic periods as commanded by the frequency of the oscillator. The amplification of the first tube in the power amplifier is made to decrease and not increase; if the latter were employed, distortion would result in the amplifier output.

It is of cardinal importance that the amplitude of the rectified voltage be controlled so that the auxiliary bias injected into the grid of the first amplifier tube (power amplifier) varies in exact proportion with the audio-frequency volume output. This guarantees that all amplified voltages shall receive the proper tremulant shading. For example, during a pianissimo passage the voltage at the output would be relatively small and therefore the value of the injected voltage would likewise be smaller, and conversely, during fortissimo passages, the voltages would be higher, hence the amplitude of the pulsating bias would be greater.

The overall depth of the tremulant effect can be varied in addition to its functioning automatically by manipulating potentiometer P_1 . The frequency being modified by adjustment of

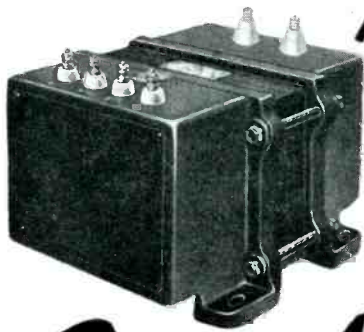

Type W plate transformers and reactors for all small and medium high-voltage rectifiers.

Transformers for Electronic Circuits

... IN ALL RATINGS;
FOR ALL REQUIREMENTS

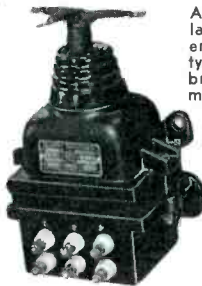

AmerTran modulation transformer, oil-immersed type, for large broadcast transmitters.

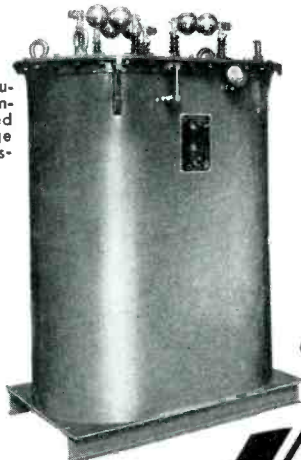

Continuous research work by our engineers since the early days of radio has made and maintained the AmerTran trademark a symbol representing the ultimate in transformers for communication and electronic circuits. This also explains why our products are preferred and used by so many of the largest equipment manufacturers and best-equipped broadcasting stations. Today our list of products covers the complete range of transformer requirements for electronic tube circuits—from the smallest audio unit used in an air-craft radio receiver to the giant power and modulation transformers for a 50,000 watt broadcast transmitter. Furthermore, all types and sizes can be produced economically either singly or in quantity to meet your particular specifications.

Type W filament transformer, air-insulated type, for tests up to 50 Kv.

AmerTran audio transformers and reactors are available for all applications and meet exact requirements.

Type RS plate transformers and reactors, oil-immersed type, for large rectifiers.

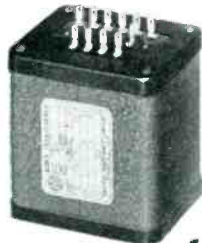

Let us submit data on transformers for your requirements.

AMERTRAN



AMERICAN TRANSFORMER COMPANY

178 Emmet St.

Newark, N. J.

Manufacturers
SINCE 1901
at Newark, N. J.

Murder or Accident?



Regardless of what caused this miniature avalanche, the miner's life was saved by a miner's helmet made from sturdy Diamond Vulcanized Fibre.

It's not likely that you manufacture miner's safety hats . . . but they serve to illustrate the versatility of Diamond Fibre and the resourcefulness of the men who make it. In this instance a light, thin shell of tremendous mechanical strength was specified — strength that had to withstand 50 blows from an 8½ lb. steel ball dropped 7½ ft. without rupturing the finished helmet. The same brains and experience that solved this problem are available at all times to you—and without charge.



Use C-D ENGINEERING AND LABORATORY RESEARCH TO SOLVE YOUR ELECTRICAL AND MECHANICAL INSULATION PROBLEMS

ALMOST every day you face the problem of meeting changing standards of product performance. You must devise new and better ways of manufacturing procedure and *find materials suited to meet these changes*. That's where the Continental-Diamond Research Laboratory can help you. Continental-Diamond materials are versatile. As a result of our laboratory research and manufacturing control we can vary individual properties to meet exacting requirements.

Many special materials developed by the C-D Laboratory have become almost standard because of the rapid advances made in all industries toward more efficient and more economical product performance. To mention a few; first, C-D VULCOID, a material combining to a remarkable degree the desirable properties of both vulcanized fibre and phenol fibre; then C-D DIAMOND-DILECTO, developed to combine the greater arc resistance of vulcanized fibre with the moisture resistance of phenol fibre; and C-D DILECTO NAME PLATE STOCK, a white core black surface sheet material, which when engraved exposes the white core for striking and effective contrast and permanent name plates.

Our booklet GF 13, just off the press, gives complete data on standard grades, forms and sizes of C-D materials. Your design, production and purchasing men will want copies.

CONTINENTAL-DIAMOND FIBRE CO., Newark, Del.

the variable condenser bank C_{1x} and C_{1y} .

The design of the oscillator circuit embodies the principles of degenerative feedback through a tungsten lamp which has a positive voltage to resistance characteristic. The resistor R_2 is in series with the lamp, hence any increments in the amplitude of the generated oscillations increase the cathode current and because of the characteristics of the lamp, any increase in current increases its resistance; therefore, increasing the cathode resistor raises the degenerative feedback voltage which opposes any increments of the oscillatory voltage thereby maintaining the amplitude to the oscillator at a constant level at all frequency settings. The oscillation intensity of the circuit can be checked by connecting a simple oscilloscope into the plate circuit of the 6V6GT tube. In conducting the test, the wave form values can be modified by either increasing or decreasing the fixed resistor R_2 ; in general, a high oscillatory intensity can be decreased to any operating value by decreasing the value of R_2 and, conversely, increasing the value has an opposite effect.

It is required that the complete variable condenser assembly C_{1x} and C_{1y} be insulated from the chassis containing other units of the circuit complement. This means that both frame and shaft of the condenser are above ground potential and must be well insulated.

A small percentage of the maximum power available at the output of the power amplifier is ordinarily sacrificed through the coupling of the diode to the plate circuit of the amplifier, but this

• • •

INVENTION AIDS MUTE MAN



John J. Smith lost the power of speech nearly nine years ago when his entire vocal chords were removed. But through the invention of the Sonovox, by Gilbert Wright, Mr. Smith can form words silently with his lips and the buzzing sound from the device passing into the throat, comes out of the mouth as words

Welcome — to 10 More Manufacturers Added to ELECTRONICS' Growing List of Advertisers

Since January 1st, eight of these have joined the progressive group of manufacturers who are using **ELECTRONICS** as a profitable printed sales medium for their products. Two others are on contract to start with full pages in the March issue.

*Note below the wide variety of products being offered. **ELECTRONICS** has horizontal coverage and deep penetration in all the important industries where the electronic circuit is used. Consequently, its circulation presents a profitable market for these products and for the many other products advertised in each issue.*

This issue:

ACCOUNT	AGENCY	PRODUCT
BROWNING LABS. Winchester, Mass.	C. Brewer Smith	Frequency Checking Meters
HARDWICK-HINDLE, New York, N. Y.	H. M. Kiesewetter Adv. Agency	Resistors
LEWYT METAL PRODUCTS CO., New York, N. Y.	Franklin Industrial Service	Large Metal Stampings
N. Y. TRANSFORMER CO., New York, N. Y.	Terrill, Belknap, Marsh Assoc.	Transformers
FRANK REIBER, INC., Los Angeles, Calif.	Edwin E. Martin Advtg.	Recording Equipment

January issue:

AMERICAN PLATINUM WORKS, Newark, N. Y.		Precious Metals
DEJUR AMSCO CORP., Shelton, Conn.	Reiss Advertising	Instruments
A. W. FRANKLIN MFG. CO., New York, N. Y.		Small Radio Parts

March issue: Two new advertisers start in **ELECTRONICS** with full pages in color and bleed.

Ten new advertisers since the first of the year is a more impressive figure coming after the record set by **ELECTRONICS** in 1940. (40 new advertisers. 30.6% increase in paid advertising space.) The swing toward **ELECTRONICS** as the Number One medium for reaching industry is

continuing. As one of the most important publications for sales approach to the defense industries, **ELECTRONICS** is being used by manufacturers who wish to direct their sales messages to the design and production engineers in the plants manufacturing defense equipment.

If you have not yet investigated the market **ELECTRONICS makes available to you, write today for complete data.**

electronics

A McGraw-Hill Publication

330 West 42nd St., New York, N. Y.

ELECTRONICS — February 1941

57

For Maximum Vacuum Tube Protection

The
**COLLINS
 RADIO
 COMPANY**
 have equipped
 their **NEW**
**5kw 21A
 TRANSMITTER**

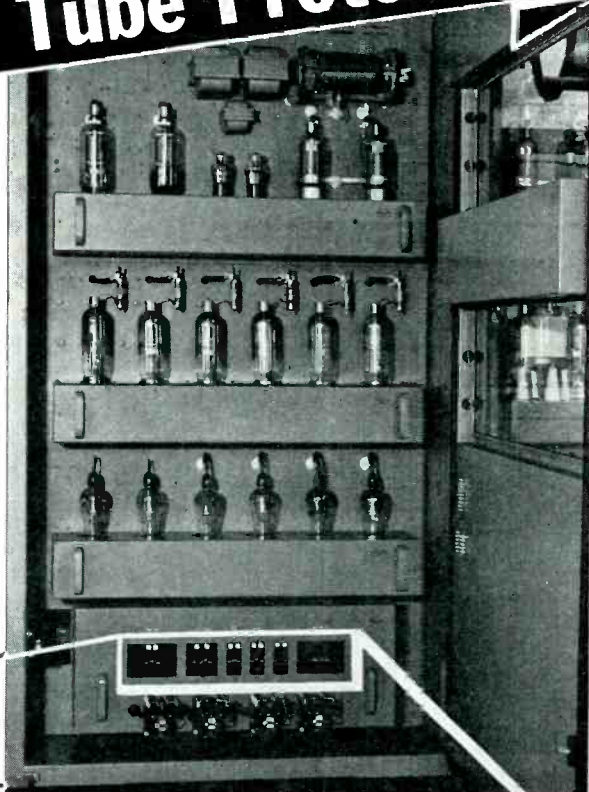

with

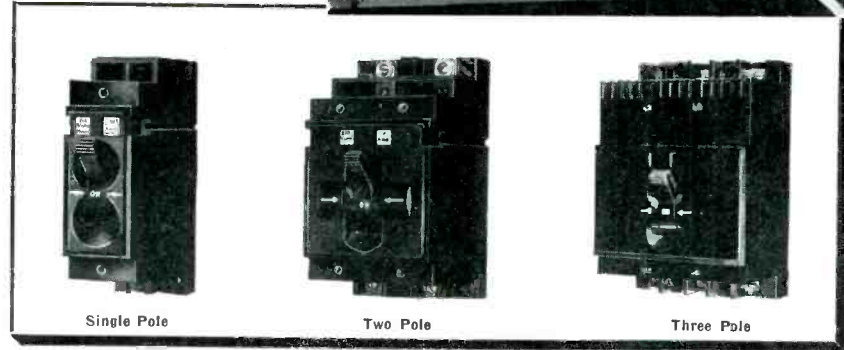

HEINEMANN CIRCUIT BREAKERS

Here's positive protection against short circuits and dangerous overloads on equipment operating on any specified current from 50 milliamperes to 50 amperes. The device opens instantaneously and can be reclosed as soon as the trouble is located and corrected. Hydraulic time delay action is optional at no extra cost. All breakers are accurately calibrated, set and adjusted at the factory and the magnetic trip unit is hermetically sealed to prevent tampering.

HEINEMANN
 CIRCUIT
 BREAKERS
 increase life of
 tubes . . . save cost-
 ly replacements . . .
 keep broadcast in-
 terruptions at a
 minimum . . . are
 fully electro-mag-
 netic . . . small in
 size, low in cost.

Send for Catalog
 No. 40 showing
 complete line.

HEINEMANN CIRCUIT BREAKER CO.
 97 PLUM ST. - - - - TRENTON, N. J.

can be reduced to a very small value by either using the value of the condenser given or one having smaller capacity. The time-constant of the operate cycle from this rectifier to the expanding amplifier (second section 6F8G) is the product of R_s and C_s . The release time is the product of R_s and C_s plus the operate time.

The operate time for the compressor circuit or control to the 6K7 (input to amplifier) is the product determined by R_s and C_s . The release time is the time constant of the 6H6 rectifier which must be less than the lowest frequency of the oscillator.

. . .

Vitamin A Concentration Measured with a Phototube

BY MEASURING THE ULTRAVIOLET LIGHT absorbed by a vitamin A solution, a phototube is used in the Bills and Wallenmeyer electronic photometer to determine vitamin A concentration.

The light source of the photometer is an argon glow lamp having strong emission bands at about 318 and 338 millimicrons, which are well within the vitamin A absorption band and close to its maximum. These lines are isolated from the rest of the argon spectrum by means of a filter which absorbs all light to which the phototube is insensitive. The U.S.P. reference cod liver oil used as a standard for purposes of comparison, and permits readings of the vitamin content to be obtained directly from dial readings rather than from a calibration chart. A two-stage amplifier is used to provide the required sensitivity.

. . .

Electronic Device Increases Skating Rink Attendance

IT WOULD BE TOO MUCH TO SAY that the attendance at such places as auditoriums can be increased in direct proportion to the number of electronic devices employed. But the Alexandra Skating Rink, at Hamilton, Ontario, increased its attendance by 40 per cent through a modernization process, in which a Precipitron air cleaner was installed as part of the new equipment.

It was realized that dust, smoke and dirt in the air played a part in the poor attendance at the rink. Consequently when plans for modernization went into effect, 20 Precipitron cells having a cleaning capacity of 15,000 cubic feet per minute were installed to take care of the 150,000-cubic foot hall. While the benefits from the installation of this equipment include elimination of dust, dirt, smoke and the chalky skating dust which previously had filled the atmosphere of the rink, the greatest improvement has been in increased attendance and increased revenue. The average attendance throughout the week has been increased by 40 per cent.

Here Is The New, Improved LINGO **FM** TURNSTILE ANTENNA

(PATENTED)

*The Most Awaited FM Development
Since The Introduction of FM Itself!*

Offering These New Features!

1. Antenna radiates a horizontal polarized signal with uniform circular field pattern.
2. Antennas are custom built, and factory adjusted to the operating frequency, making no field adjustments necessary.
3. Design incorporates an improved and greatly simplified method of feeding and coupling.
4. Turnstile elements are fed by coaxial lines, and no open turnstile wires are used.
5. Lighting equipment and climbing steps may be installed without interference to the operation of the turnstile.
6. Heating elements can be used in turnstile arms for sleet melting where necessary.
7. Antennas are available with 2, 4, 6, 8 and 10 layers of turnstile elements, depending upon desired gain.

Now Available for Installation on Towers or Building Roofs

The introduction of this new improved LINGO FM Antenna marks another progressive step in the march of Broadcasting. LINGO has pioneered in the field of Frequency Modulation, and offers this new turnstile antenna as a distinct improvement over all previous designs. This major improvement in FM Antenna design is not an experiment. It has been completely developed, and the performance has been proved by actual tests.

Quotations will be gladly submitted for individual applications only, and will include the essential tubular steel mounting pole, turnstile elements, coupling equipment, transmission lines feeding the elements, etc. Climbing steps, lighting equipment, and sleet melting units, are also available as optional equipment. The erection of the Turnstile Antenna on your supporting tower, or building roof, can also be included.

JOHN E. LINGO & SON, INC. DEPT. E-2 CAMDEN, N. J.

LINGO VERTIC
TUBULAR
RAD
TEEL
ORS

**HERE'S THE FM
ANTENNA YOU'VE
BEEN WAITING FOR!**

You'll want to know about this New Lingo Antenna — Write today for complete facts and please indicate your proposed frequency, power and location. Similar Antennas Are Being Developed For Television. Write for Preliminary Information.

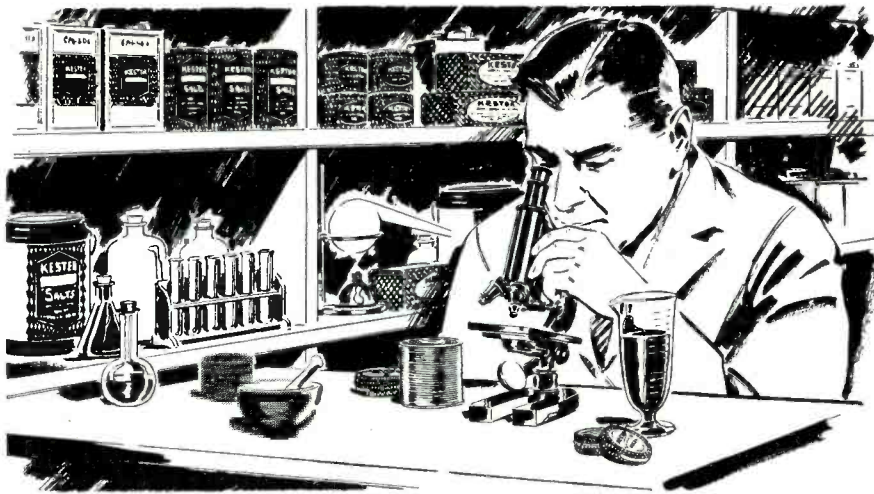

What is **THE KESTER** **SOLDER-PRESCRIPTION** **SERVICE?**

Here is a sound approach to a basic production problem—one that may be causing difficulty in your business right now!

The problem is to find the right solder for each metal-joining operation.

This means the *solder-alloy* must be right for the metals or alloys with which it unites; the *solder flux* must be the right type, right strength and right amount to clean the work thoroughly without damaging it; and, finally, the *solder strand-size* and *core-size* must be conveniently proportioned for easy handling.

These four elements, underscored above, must be scientifically determined by someone who knows the answers. The men who operate the Kester Solder-Prescription Service are qualified. They draw on 44 years of soldering experience. At their disposal are:

- 100 different solder alloys
- 10 different solder fluxes
- 80 different solder strand sizes
- 4 different solder core sizes

The combinations are almost endless—so if you're after the best possible soldering results, let Kester prescribe the solders.

Mail a detailed description of your metal-working problems to the address below, and you will promptly receive your Kester Solder Prescription.

You incur no obligation in making use of this service.

KESTER SOLDER COMPANY

*  4204 Wrightwood Avenue Chicago, Illinois
Eastern Plant: Newark, N. J.
Canadian Plant: Brantford, Ont.

The Symbol of
Kester Solder-
Prescription
Service.

KESTER CORED SOLDERS
STANDARD FOR INDUSTRY

Television Standards

(Continued from page 21)

at Camp Upton relayed the video and audio signals over a distance of 17 miles to the first radio relay station at Hauppauge, from which it was automatically relayed to the second relay station at Bellmore, L. I., over a distance of 23 miles. The automatic transmissions from the Bellmore relay were picked up 28 miles distant by horn antennas located on the 62nd floor of the RCA Building, whence they were cabled to the receivers on the 67th floor. The total distance over which these camp scenes were transmitted was 68 miles, and the two intermediate relay stations were entirely unattended by local operators during the transmissions. Because of poor weather these telecasts were not of the best quality, and could not, fairly, be compared with programs originating in the local studio. But they were comparable to newsreel films taken under the same conditions and were decidedly acceptable.

Highlight of the entire two-day demonstration was the afternoon demonstration of RCA when theater screen television programs were shown on a 15x20-foot screen at the New Yorker Theater, with detail and definition equal to that of modern high quality home television receivers. Line structure was visible although not objectionable to the audience seated at the rear of the house. Screen brightness and contrast did not appear to be equal to that of the usual motion picture film, but the definition was sharp to the edges, and the pictures were highly satisfactory.

As for the theater program itself, both studio and remote pick-up scenes were shown in which the automatic radio relaying from Camp Upton again played an important part, and a multisonic sound system was employed to create the effect of stereophonic aural reception. A play, "K-7", recounting some of the spy activities of the first World War more than utilized the full capabilities and output of the multisonic sound system when the roar of a squadron of airplanes was pre-

USES 96 SLIDING CONNECTORS ...ALL MADE OF MONEL

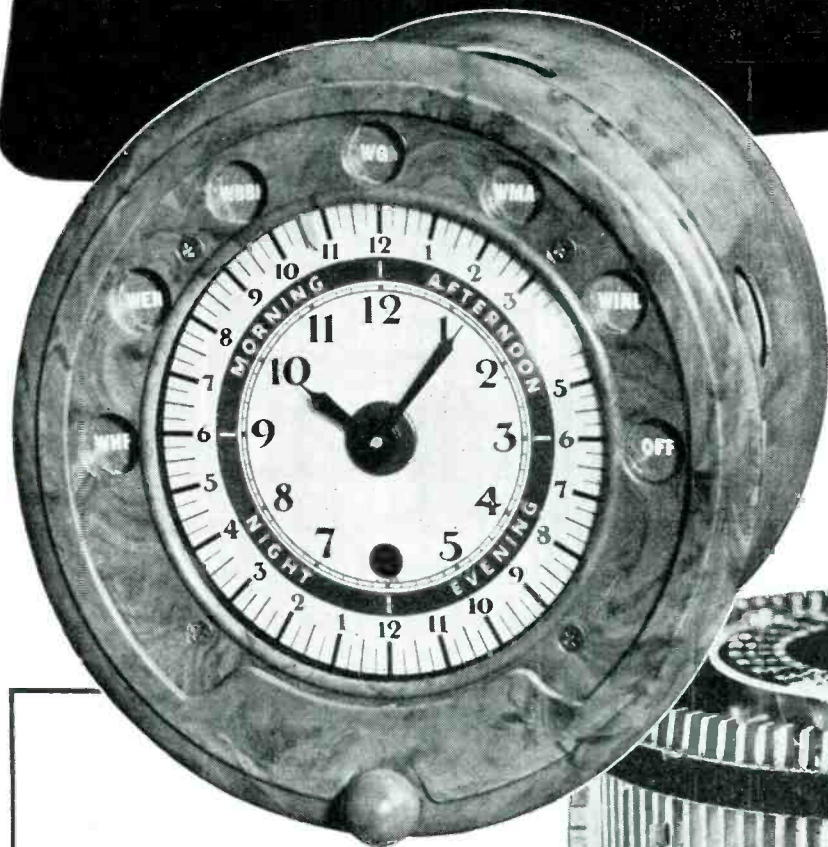

Motorola automatic tuning clock. Also suitable for control of industrial heating systems, arson sprinklers, etc. View below shows sliding connectors made of spring temper Monel.

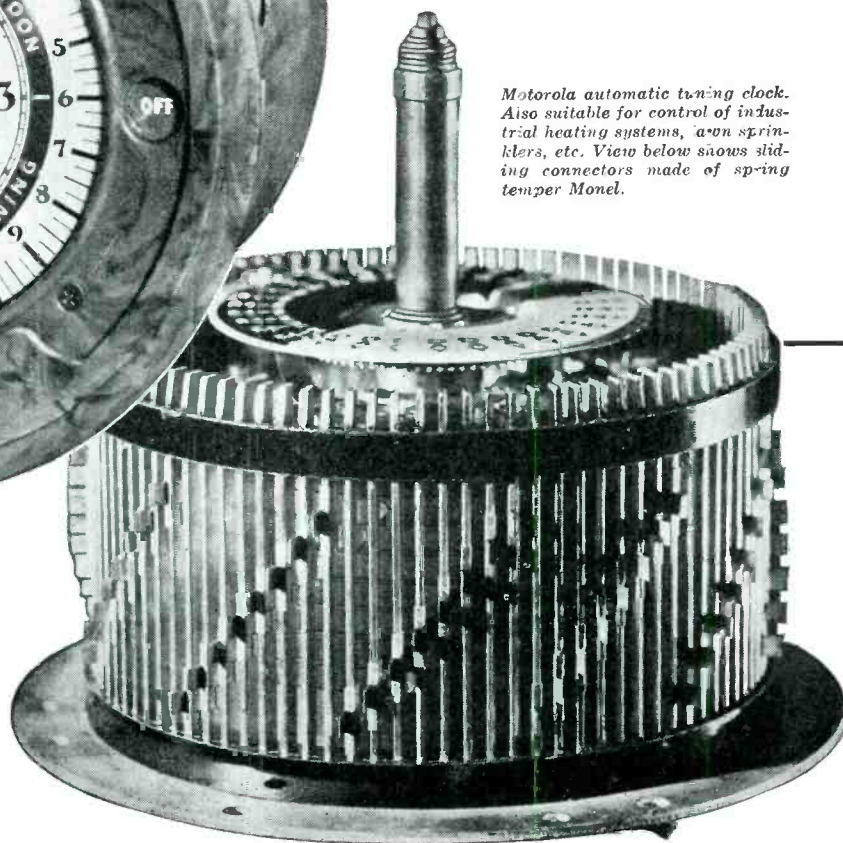

This alloy selected because it meets all requirements in a way approached by no other metal

Announced by Galvin Manufacturing Corporation of Chicago, this new clock mechanism will tune in any one of six stations at any quarter hour throughout the 24 hour day. For the 96 sliding connectors needed to do the job, careful consideration was given to every available material. Monel alone answered *all* requirements, for this alloy is:

1. Rust proof and highly resistant to corrosion.
2. Resistant to fatigue and vibration.
3. Has good electrical properties.
4. Is available in desired spring temper.
5. Is easy to fabricate.

Offering such an unusual combination of properties, Monel may well prove the ideal material for *your* requirements. Write for information and samples. Ask for Bulletin T-5 "Engineering Properties of Monel." Address:

THE INTERNATIONAL NICKEL COMPANY, INC.
67 Wall Street New York, N. Y.



"Monel" is a registered trade-mark of The International Nickel Company, Inc., which is applied to a nickel alloy containing approximately two-thirds nickel and one-third copper.

RADIO CONTROLS
 COMMUNICATIONS
 REMOTE CONTROLS
 DELAYED ACTION
 MULTIPLE CONTACT
 GOVERNMENT SPECIFIED
 INTERLOCKING CONTROLS

?

STEPPING RELAYS
 SOLENOIDS
 AIRPLANE CONTROLS



What's Your Control Job . . . ?

★ Before you went very far on your latest contract . . . defense or otherwise . . . you were confronted with a CONTROL PROBLEM. It's one you never met before . . . it STOPS you . . . perhaps for a day . . . a week . . . even months until solved.

RELAYS by GUARDIAN

Many extraordinary control problems are quite familiar to GUARDIAN . . . and even things that have never been done before often yield surprisingly quick to the experience of Guardian engineers. Usually a combination of our stock items (more than 7,000) economically assembled into a control unit, relay, solenoid or automatic switch, will turn the trick for you.

TO THE MAN WITH A SPECIFIC CONTROL PROBLEM:

Guardian offers a specific solution, HERE and NOW! All you have to do is write us. Tell us what the conditions are . . . and what you want accomplished.

Send sketch or blue prints if available. The consultation, analyses and recommendations of Guardian's engineering staff are yours to command without cost or obligation.

Initial Your Letterhead For New 1941 Catalog "E" Today. Write

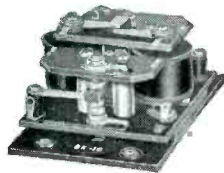

Series BK-16 Relay. Built to minimum tolerances and the most exacting requirements in production quantities for the U. S. Signal Corps.

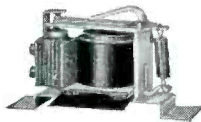

Series 120 AC Relay. This relay which sells for less than \$1 has operated over 85,000,000 times in an electric fence control, and still remains in excellent condition.

And These Are Not the Extremes in the Guardian Relay Line!

GUARDIAN ELECTRIC

1625 West Walnut Street



Chicago, Illinois

sented. But entertaining as this was, nothing in the two-day demonstration quite came up to the comparison which was given of direct studio-theater pick-up with automatic radio relaying over a total distance of approximately 130 miles. An image of the announcer, transmitted by coaxial cable from the NBC studio was first flashed on the screen. Then the transmission system was changed over so that the video and audio signals were broadcast from the transmitter atop the Empire State Building to the mobile unit at Camp Upton where they were received and relayed back to the RCA Building through the two-station automatic relay stations already mentioned. Of course some definition was lost in transmitting the signals over this 130-mile path, but the results were decidedly commendable—sufficiently so as to cause the entire audience of technical representatives to break into a round of whole-hearted, spontaneous applause. There was no denying that this was television on a scale long talked of but not attained, both as to technical as well as entertainment merit.

Following the demonstrations of radio link relaying, the Bell Telephone Laboratories put the New York-Philadelphia coaxial cable through its paces to show that television transmission via cable, over distances of at least 200 miles, was technically feasible, and that the detail lost in transmitting signals over a cable of this distance was so small as to be unnoticed except by critical examination of pictures having much detail in the horizontal direction. Direct comparisons between pictures originating in the Laboratories and transmitted a distance of 50 feet were made with the same pictures transmitted 200 miles, to Philadelphia and back. From the normal viewing distance, very little, if any, degradation of the image travelling over the longer path could be observed, in spite of the fact that the cable was corrected for a frequency channel of 2.75 Mc instead of the 4 Mc available in the television channel. The advantage of coaxial cable over radio relaying links in the event of electrical storms and disturbances was also brought out.

On Saturday morning the members of the F.C.C. and the N.T.S.C. witnessed a demonstration of the

Erie Plastics

WILL MAKE YOUR RECEIVERS **STAND OUT**

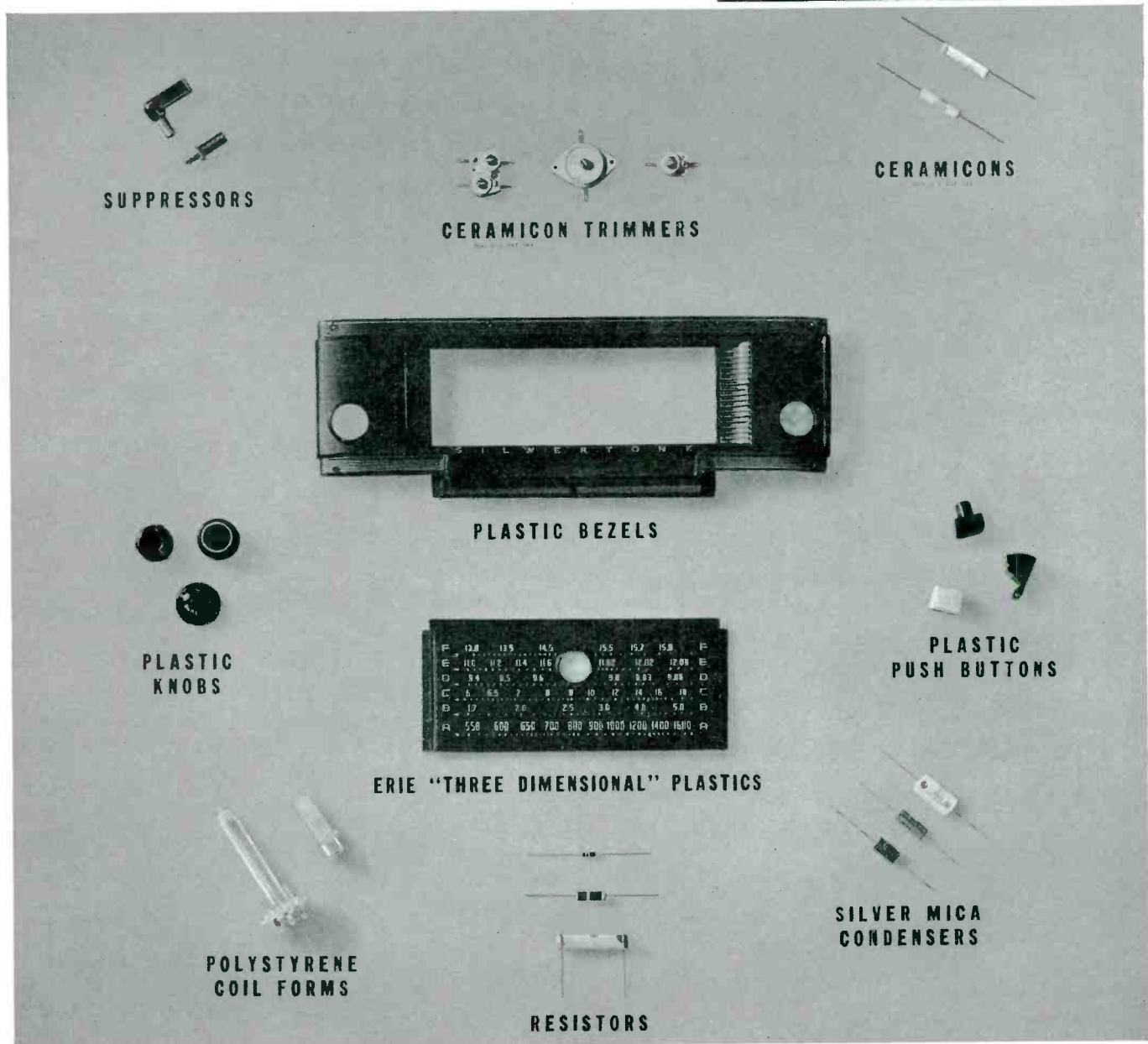

Erie Resistors and Condensers

WILL MAKE THEM **STAND UP**

With the general public becoming more and more plastic conscious, it requires sound engineering and correct molding technique to produce outstanding plastic moldings. Erie has both the engineering background and the modern equipment necessary to maintain high standards of quality in custom molded plastics for the radio field.

Erie radio components include insulated and plain carbon resistors; suppressors; silver mica condensers for preventing condenser capacity drift; Ceramicons and Ceramicon Trimmers for compensating for frequency drift in other components; and low-loss polystyrene coil forms. Use these Erie products in your radios for dependable performance.

ERIE RESISTOR CORPORATION . . . ERIE, PA.

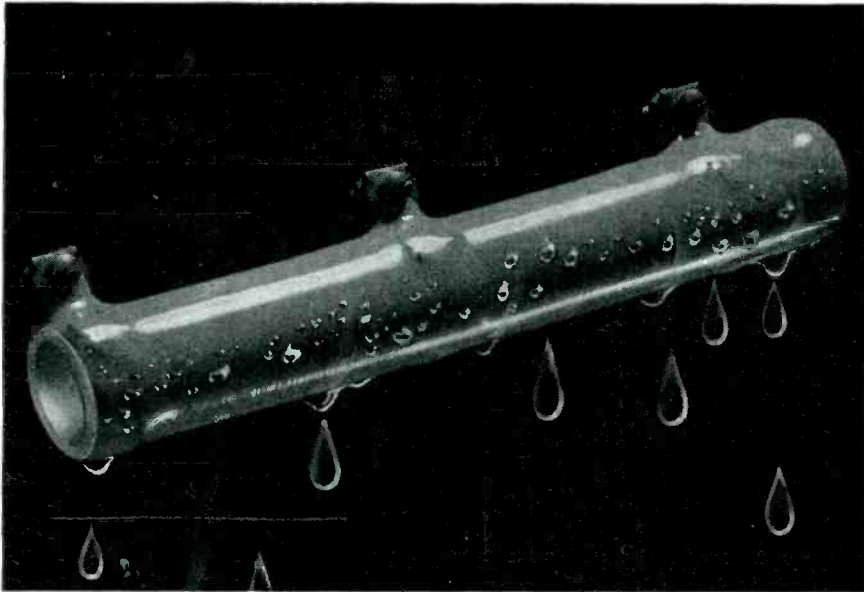

WHEN A RESISTOR SWEATS



Moisture, visible or invisible, will cause trouble if it can penetrate the protective surface of a resistor. A microscopic examination of the surface of a Ward Leonard Vitreous Enamelled Resistor will show why this Resistor is able to give satisfactory service under all climatic conditions. Its freedom from even minute enamel crazes or cracks is unique. With such complete protection of the wire, moisture is effectively excluded. The Vitreous Enamel of Ward Leonard Resistors is processed at a temperature above 1400° F. Thus all elements of the enamel are perfectly fused and envelop the wire in a sealed, protective, glass-like enclosure.

RESISTOR BULLETINS

Bulletin 11 tells about Vitrohm Enamel Wire Wound Resistors, gives sizes and watt ratings.

Bulletin 19 describes Ward Leonard Ribflex Resistors for unusually heavy duty.

Bulletin 22 is on the subject of Non-Inductive and Non-Capacitive Resistors.

Bulletin 25 is a treatise of standard and special Resistor Mountings and Enclosures.

Send for bulletins of interest to you.

WARD LEONARD

ELECTRIC COMPANY

Electric Control Devices Since 1892

Ward Leonard Electric Company, 32 South Street, Mount Vernon, N. Y.

Please send me Resistor Bulletins Nos.

Name

Firm

Address

City State



C. B. S. system of color television utilizing the normal television transmission facilities and band-width, with color provided by means of red, green, and blue filters rotating in front of the white screen of the cathode ray tube. The demonstration was similar to those given before the Institute of Radio Engineers in October and again in January, except for the inclusion of one or two of the most recent developments. Both live and film pick-ups were demonstrated, the latter in black and white as well as in color so that the full advantages of color could be appreciated. The more familiar television receiver with its black and white image was shown side by side with two receivers producing color pictures for further comparison of the two systems. All images were approximately 5x7 inches in size and all transmissions were carried out using the usual 4-Mc channel assignments. Features demonstrated at this showing, and not previously shown before I.R.E. groups, included the fading of one picture into another by means of multi-channel operation and the employment of fluorescent lighting for studio illumination.

The purpose of the C.B.S. demonstration was to show that three-color television in the regular 4-Mc channels is a distinct possibility with entertainment and educational advantages not present with black and white images, that there is no color break-up even with fast moving objects, that the studio lighting required for color television is not necessarily any greater than that required for an equivalent black and white system, that the low-temperature fluorescent lamps can be used to provide studio illumination, that the introduction of color television does not necessarily introduce intricate or difficult operating procedure, either in the studio or in the home, and that the 24-frame film scanner developed by C.B.S. engineers makes it possible to use any color amateur or professional film for the production of color television.

To wind up the two-day display of electrical images, Scophony Television, Ltd., staged a demonstration of large screen television using a mechanical scanning system developed in England. Solomon Sagall, director of Scophony in this country,

FORMICA
TUBING, PUNCHED
or MACHINED PARTS
of
Dependable
Insulation!

FORMICA laminated phenolic sheets, tubes and rods have served leading American electrical manufacturing organizations as a preferred insulating material for more than 28 years.

There are a great variety of grades and types developed to emphasize particular qualities of the material for special purposes — so that a material is available that meets the requirements of the most varied applications.

We will be glad to recommend a grade or type to meet your conditions. Send us blue prints for quotations.

THE FORMICA INSULATION CO.
4661 Spring Grove Ave., Cincinnati, O.

FORMICA



STRENGTH

.. one of three extra values

The strength of Blaw-Knox towers shows up under severe conditions. It is revealed in low maintenance cost, and — ultimately — in much longer life. And what the structural engineer has done to make these towers sound and strong, the electrical engineer has done to give them the extra efficiency that means wider radio coverage. Add pleasing appearance due to correct designing — and you have the three extra values of Blaw-Knox towers. We'll gladly discuss your antenna problem with you. Write or wire.



BLAW-KNOX DIVISION
OF BLAW-KNOX COMPANY
FARMERS BANK BLDG. PITTSBURGH, PA.
Offices in Principal Cities

took care to point out that the images to be seen were not representative of latest Scophony developments which had been curtailed by the war. None the less, the live pick-ups, projected in black and white, on screens 3x4 feet and 9x12 feet in size, and using R.M.A. television standards were highly interesting. Definition and illumination was noticeably greater at the center of the screen than at the edges and, again, the screen brightness and contrast were not quite up to modern motion picture standards which have half a century of progress back of them. But one seeing large screen television for the first time could not fail but be impressed. Mercury arcs were used as the light source, and the pictures were projected on the rear of the translucent screen.

All in all, the two-day show provided an excellent opportunity to become acquainted with the results of modern television development and showed that present-date television has educational and entertainment capabilities comparable to 16-mm motion pictures. Those organizations having experience in the field showed that the program technique and studio operation had been developed to the point where telecasts can produce material on an entertainment, educational, and cultural level equal to that of motion pictures. Conclusive proof was given of the practicability of large screen and color television, and the successful transmission of television signals by cable and radio relay links at least up to 150 miles.—B.D.

• • •

SOLDIERS TAKE UP COMMUNICATION TRAINING



A field radio set in operation at the Aberdeen Proving Grounds, Aberdeen, Md. where Army men are taught the rudiments of Army communication methods

TUBES

Midget tubes about the size of a pilot light are announced, together with data on tubes registered in December 1940 and on older types not previously listed

Super-Midget Tubes

A NEW CONTENDER for the title of smallest tube has appeared on the scene. In the battle to achieve the smallest possible size, the radio tube has at last reached a size comparable with that of

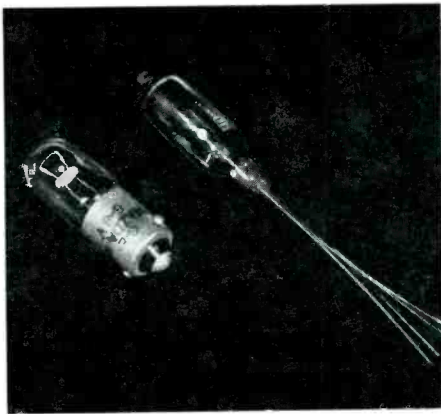

The Microtube compared with an ordinary radio pilot lamp

the pilot lamp as shown in the photograph. The new tubes, of which there are two types, are manufactured by Microtube Laboratories of Chicago. The length of the envelope is slightly greater than one inch and the diameter is 3/8 of an inch. No base is used and the leads are tinned ready to be soldered into the circuit.

The small size of these tubes is made possible by a unique method of construction. The metal used in the plate has very low emissive properties so that the suppressor grid is not necessary. Also, the deflector plates have been eliminated. Thus, the overall diameter of the electrode structure is considerably decreased. The overall size of the structure is 1/4 inch by 1/4 inch by 1/8 inch.

The filament is oxide coated with the thickness of oxide heaviest at the midpoint of the filament and tapering off towards the ends. This permits a more even temperature at the surface of the emitting material and at the same time reduces the heat losses. Maximum life of the filament also results.

A tetrode voltage amplifier, type M-74, and a tetrode power amplifier, type M-54, make up the line. Beam tube action is achieved despite the absence of deflector plates because a split plate, open at both ends around the grid supports, is used. The deflector plates are not necessary because

there is no plate field at the points where they would be located. The characteristics are as follows:

Type M-74

Voltage Amplifier

Filament Voltage	0.625 v
Filament Current	0.020 ma
Plate Voltage	45 v
Screen Grid Voltage	22.5 v
Control Grid Voltage	0 v
Plate Current	0.34 ma
Screen Grid Current	0.07 ma
Plate Resistance	0.5 megohm
Transconductance	125 micromhos
Amplification Factor	63

Type M-54

Power Amplifier

Filament Voltage	0.625 v
Filament Current	0.40 ma
Plate Voltage	45 v
Screen Grid Voltage	45 v
Control Grid Voltage	-4 v
Plate Current	0.8 ma
Screen Grid Current	0.1 ma
Plate Resistance	13,000 ohms
Load Resistance	35,000 ohms
Power Output	5 milliwatts

These tubes were designed for use in very small electronic equipment such as hearing aids and small receivers. In such operation, two tubes are normally connected in series across a single dry cell to apply the proper voltage to the filaments. If a type M-54 tube with a 40-ma filament current and two type M-74 tubes with 20-ma filament currents are used they are connected in series-parallel across the dry cell.

Tube Registry

Tube Type registered by R.M.A.
Data Bureau During December 1940

Type 7Z4 (GL)

FULL-WAVE rectifier, heater type, T-9 integral glass envelope-base, maximum seated height 2 3/8 inches, 6-pin lock-in base.

$E_h = 7.0$ v
 $I_h = 0.96$ amp
CONDENSER INPUT
TO FILTER
 E_{ac} (per plate) = 325 v (max)
 $I_{dc} = 300$ ma (per plate max)
 Z (plate supply) = 75 ohms (min)
CHOKE INPUT TO FILTER
 E_{ac} (per plate) = 450 v (max)
 $I_{dc} = 300$ ma (per plate max)
 L (plate supply) = 6 henries (min)
 E (inverse) = 1250 v
 E_{drop} (I_{dc} per plate = 100 ma) = 40 v
 E (heater-cathode) = 450 v (max)
Basing 5AB-L-O

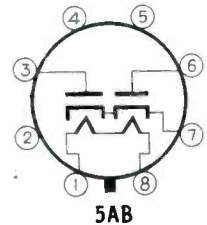

INDUCTION ELECTRON ACCELERATOR

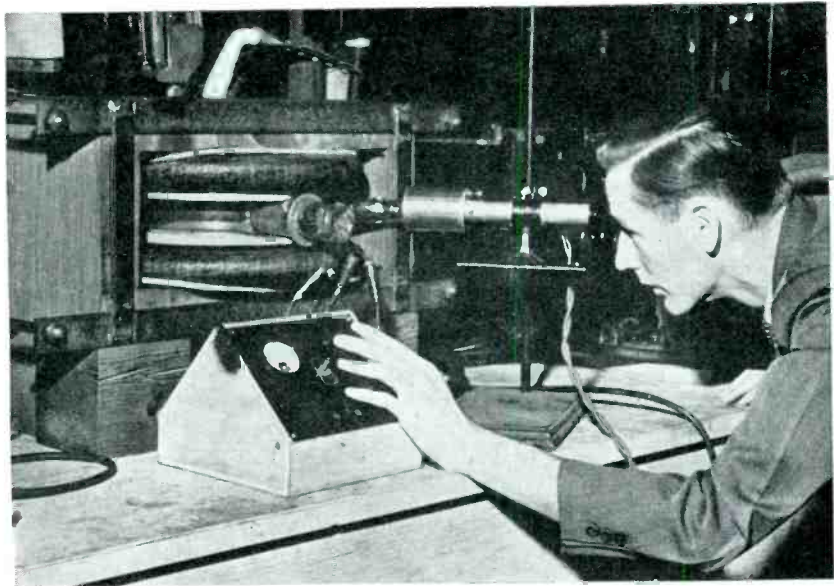

Electrons travel with a velocity approaching that of light in this doughnut shaped vacuum tube known as the induction electron accelerator. It is used in atom bombardment and was designed by Dr. D. W. Kerst of the General Electric Research Laboratory

POPULARLY PRICED

For General Laboratory Use
And Production Testing



● Rugged, precise, reliable . . .
input and output impedances
independently adjustable.

● Ideally suited to F.M.—
Studio and other wide range
sound system measurements.

ATTENUATION NETWORKS

SERIES 690 AND 692

for Transmission-Efficiency, Power-Level Measurements, Impedance
Adjustments, Gain or Loss Measurements on Amplifiers, Filters, Pads

The Series 690 network consists of plug-in input and output
adjusting networks, and a Units and Tens attenuation controls.

The Series 692 network is essentially the same as the 690
with the exception that a Tenths, a Units and a Tens attenua-
tion controls are provided. Both types, 690 and 692, are
offered in either "T" or "Balanced H" networks.

The attenuation controls are constant impedance, zero insertion loss
networks each having 10 steps of attenuation. The Daven Series 6900
Impedance Matching Networks ("plug-in" units) may be obtained in
a wide range of impedance and loss.

TYPE	Z	RANGE	CIRCUIT	PRICE
T-690-A	500	0-110 Db. in step of 1 Db.	"T" Network	\$60
H-690-B	500	0-110 Db. in step of 1 Db.	Balanced "H" Network	80
T-690-C	600	0-110 Db. in step of 1 Db.	"T" Network	60
H-690-D	600	0-110 Db. in step of 1 Db.	Balanced "H" Network	80
T-692	500	0-111 Db. in steps of 0.1 Db.	"T" Network	80
H-692	500	0-111 Db. in steps of 0.1 Db.	Balanced "H" Network	100
T-693	600	0-111 Db. in steps of 0.1 Db.	"T" Network	80
H-693	600	0-111 Db. in steps of 0.1 Db.	Balanced "H" Network	100

Supplied complete with one set of 6900 networks. Unless otherwise specified, these will
be 500 ohms or 600 ohms, zero loss networks. Base impedances other than 500 ohms or
600 ohms available upon request.

THE DAVEN COMPANY
158 SUMMIT STREET • NEWARK, NEW JERSEY

Tube Types Previously Registered
by R.M.A. Data Bureau

Type 2A6

DUPLEX-DIODE high-mu triode, heater
type, ST-12 glass envelope, maximum
seated height 3 $\frac{3}{8}$ inches, 6-pin base.

$E_h = 2.5$ v
 $I_h = 0.8$ amp
 $E_b = 250$ v
 $E_c = -2$ v
 $I_b = 0.9$ ma
 $\mu = 100$
 $r_p = 91,000$ ohms
 $\theta_m = 1100$ umhos
Basing 6G-O-5

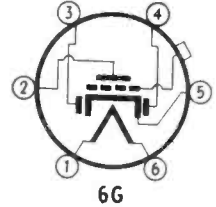

Type 6L6G

BEAM power amplifier, heater type,
ST-16 glass envelope, maximum seated
height 4 $\frac{1}{2}$ inches, 7-pin octal base.

$E_h = 6.3$ v
 $I_h = 0.9$ amp
 $E_b = 350$ v
 $E_c1 = 250$ v
 $E_c2 = -18$ v
 $I_p(\text{zero signal}) = 54$ ma
 $I_c(\text{zero signal}) = 2.5$ ma
 $R_1 = 4200$ ohms
 $P_o = 10.8$ watts
(15%)
Basing 7AC-O-0

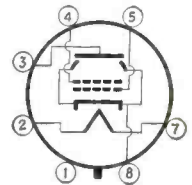

Type 6Q7

DUPLEX-DIODE high-mu triode, heater
type, metal envelope, maximum seated
height 2 $\frac{1}{8}$ inches, 7-pin octal base.

$E_h = 6.3$ v
 $I_h = 0.3$ amp
 $E_b = 250$ v
 $E_c = -3$ v
 $I_b = 1.1$ ma
 $\mu = 70$
 $r_p = 58,000$ ohms
 $\theta_m = 1200$ umhos
Basing 7V-1-1

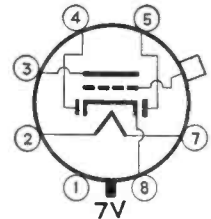

Type 25Z5

TWIN-DIODE high-vacuum rectifier,
heater type, ST-12 glass envelope,
maximum seated height 3 $\frac{1}{8}$ inches, 6-
pin base.

$E_h = 25.0$ v
 $I_h = 0.30$ amp
 $E_{h-k}(\text{max}) = 350$ v
 $E(\text{inverse peak}) = 700$ v
 $E_{drop}(I_{dc} = 150$ ma per
plate) = 22 v
VOLTAGE DOUBLER
 $E_p(\text{rms per plate}) = 117$ v
(max)
 $I_{dc} = 75$ ma (max)
Min Total Effective
Plate Supply Imped-
ance (per plate) = 30
ohms

HALF WAVE
RECTIFIER
 $E_p(\text{rms per plate}) = 235$ v
(max)
 $I_{dc}(\text{per plate}) = 75$ ma
(max)
Min Total Effective
Plate Supply Imped-
ance (per plate) = 100
ohms
Basing 6E-O-0

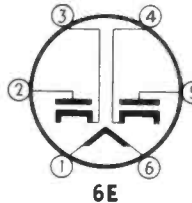

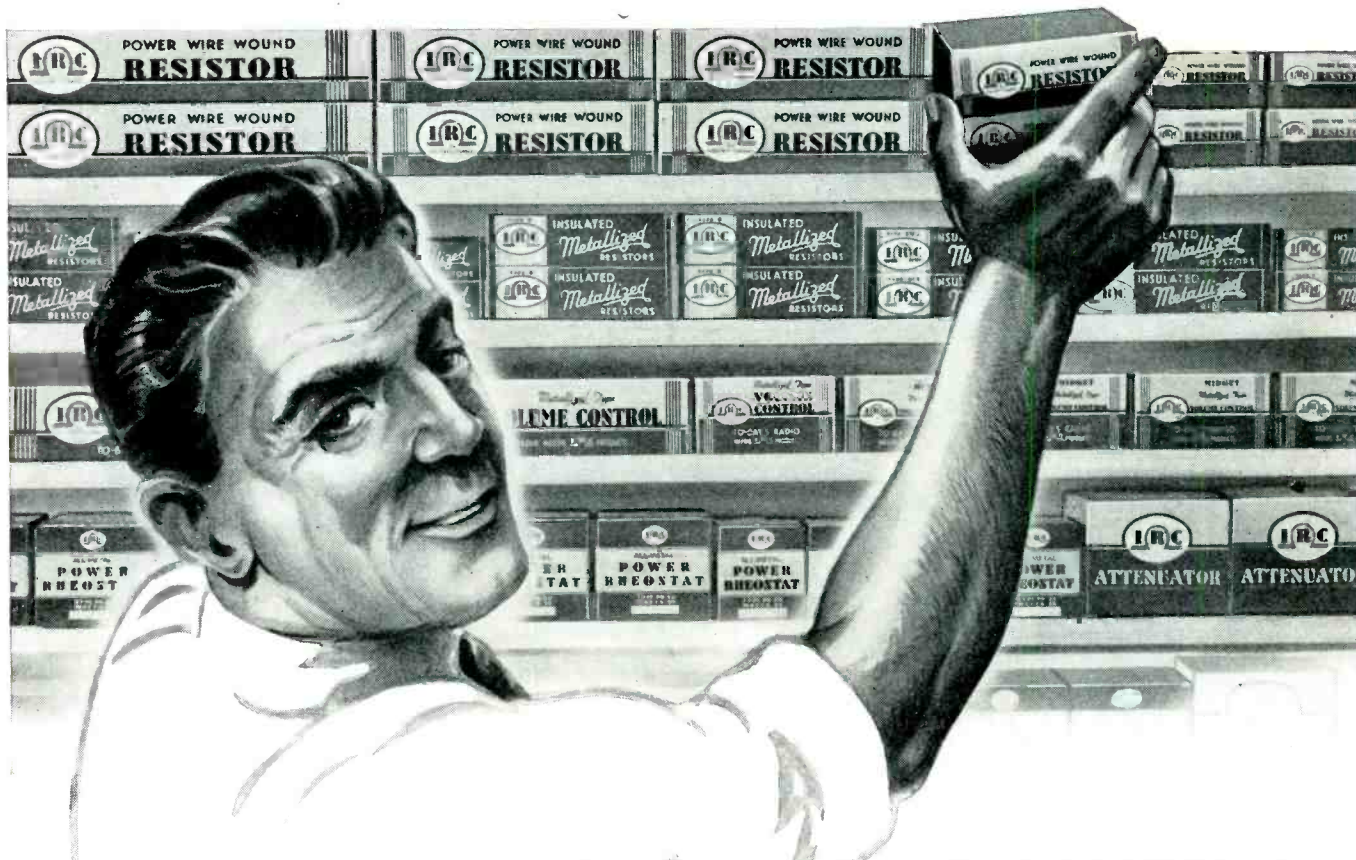

OVER 500 JOBBERS CARRY IRC RESISTORS IN STOCK

Why not select a resistor for your development and production program that not only offers assured dependability for defense or industrial needs, but which is also available from a local jobber's stock? When working under pressure, any delay caused by not having the right resistor at the right time may cause unnecessary complications in an already complicated problem.

IRC provides all types of fixed and

variable resistors plus a thorough knowledge of the requirements of the various government services. Thousands of resistors in factory stocks are backed by extensive facilities for large scale production — and still further backed by stocks of many commonly used types maintained by about 500 jobbers throughout the U. S. and Canada.

We will gladly send you names of IRC jobbers in your locality.

GET THESE RESISTOR ENGINEERING DATA BULLETINS

(Please ask for these Bulletins by Number)

- 1—Volume Controls and Potentiometers up to 2 watts and 20 meg. resistance.
- 2—Metallized Type Resistors: Insulated 1/2, 1 and 2 watts; high frequency; high range; high frequency power; high voltage power.
- 3—Insulated Wire Wound Resistors: Type BW from 1/2 to 1 and 2 watts; Type MW, 5 to 20 watts.

4—Power and Precision Wire Wound Resistors: Fixed and adjustable power types from 10 to 200 watts in all shapes, mountings, etc. Inductive and non-inductive. 14 Precision Types to as close as 1/10 of 1% accuracy.

5—Attenuators: 20 to 30 step; ladder, potentiometer or bridged "T" types.

6—Power Rheostats: Quick heat-dissipating all-metal types up to 100 watts.



NEW RESISTOR COLOR CODE CHART

Write direct or ask your local IRC jobber for one of the IRC Resistor Color Code Charts. This is printed on sturdy acetate in vest pocket size and includes both old and the revised RMA color codings, ohms law and a condensed list of IRC Resistor types.



INTERNATIONAL RESISTANCE COMPANY
403 NORTH BROAD ST., PHILADELPHIA, PENNA.

Makers of resistance units of more types, in more shapes, more sizes and for more applications than any other manufacturer in the world.

SWITCH TO STACKPOLE

for Switches

For handling small power circuits Stackpole has developed a complete line of compact inexpensive switches with innumerable applications . . . Designers can save time, money and space by getting acquainted with the wide variety of types at their disposal . . . Give us your switch problem and we will give you the answer—quickly!

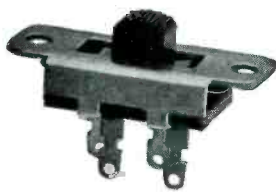

TYPE SS-7

—a three position slide switch which may be used as a three position tone switch, two speed small motor switch with off position or as a bright—dim—off light switch.

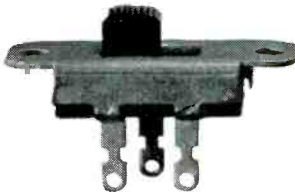

TYPE SS-9

—a single pole, double throw slide switch for use as a record reject switch or any other application requiring a momentary contact switch which is returned to its normal position when operating pressure is removed.

STACKPOLE MAKES:

- 1. VARIABLE RESISTORS—** For use as volume controls, tone controls, potentiometers for controlling voltages, rheostats for controlling current.
- 2. FIXED COMPOSITION RESISTORS —** Insulated resistors rated at 1/3 watt, 1/2 watt and 1 watt. Non-insulated resistors rated at 1/2 watt, 1 watt and 3 watt. Resistance range 10 ohms to 20 megohms.
- 3. SLIDE OPERATED SWITCHES—**A complete line of slide operated switches either indexed or momentary contact type ranging from single pole, single throw to six pole, double throw. Many of these types have been approved by the Underwriters'.
- 4. ROTARY INDEX SWITCHES—**For use as tone control sensitivity controls, or any other application requiring indexed switch positions. Available only in single pole type with maximum of four positions.
- 5. TOGGLE SWITCHES—** Tab mounting snap switches with external toggle. Approved by the Underwriters'.
- 6. IRON CORES—**Compressed powdered iron cores for use in permeability tuning, inductance trimming or fixed inductance IF coils.

WRITE FOR SAMPLES AND PRICES

In addition to the above radio products the Stackpole Carbon Company manufactures every known type of carbon products.

STACKPOLE CARBON COMPANY

ST. MARYS, PA.

Type 25Z6G

TWIN-DIODE high-vacuum rectifier, heater type, ST-12 glass envelope, maximum seated height 3 1/8 inches, 7-pin octal base.

$E_h = 25.0$ v
 $I_h = 0.30$ amp
 $E_{a-k}(\text{max}) = 350$ v
 $E(\text{inverse peak}) = 700$ v
 $E_{drop}(I_{dc} = 150 \text{ ma per plate}) = 22$ v
VOLTAGE DOUBLER
 $E_p(\text{rms per plate}) = 117$ v (max)
 $I_{dc} = 75$ ma (max)
 Min Total Effective Plate Supply Impedance (per plate) = 30 ohms
HALF-WAVE RECTIFIER
 $E_p(\text{rms per plate}) = 235$ v (max)
 $I_{dc}(\text{per plate}) = 75$ ma (max)
 Min Total Effective Plate Supply Impedance (per plate) = 100 ohms
 Basing 7Q-O-O

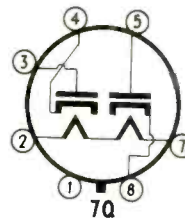

Type 20

POWER amplifier triode, filament type, T-9 glass envelope, maximum seated height 3 3/8 inches, 4-pin bayonet base.

$E_f = 3.3$ v
 $I_f = 0.132$ amp
 $E_b = 135$ v
 $E_c = -22.5$ v
 $I_b = 6.5$ ma
 $\mu = 3.3$
 $R_i = 6500$ ohms
 $P_o = 110$ milliwatts
 Basing 4D-O-O

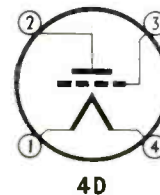

REPLACEMENT TUBES



Joseph Waldschmitt, WOR engineer, inspects one of the complete set of replacement tubes for WOR's FM transmitter, W2XOR. More than two thousand dollars worth of tubes are kept on hand ready for instant replacement when the occasion demands

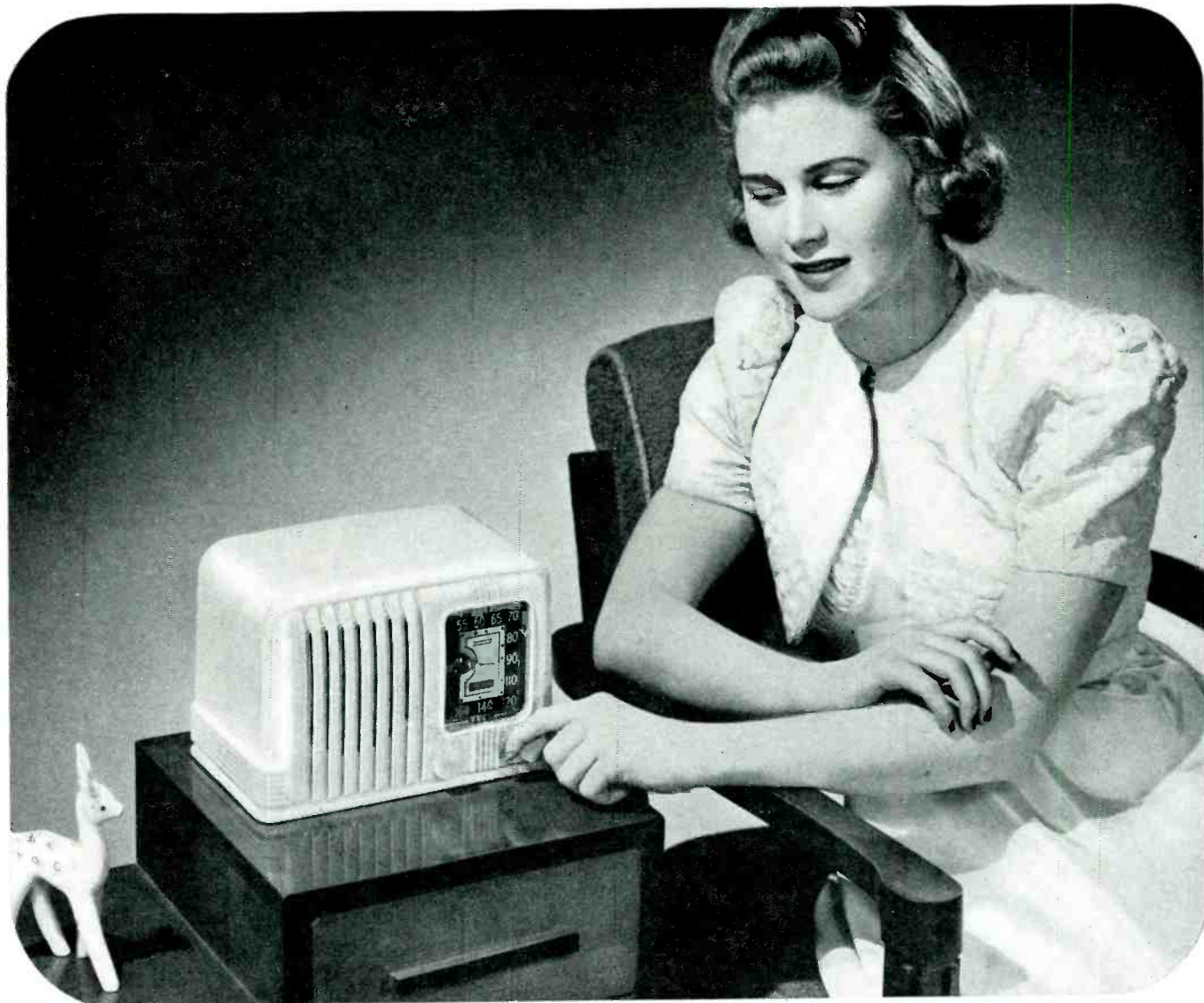

The Richness of Ivory and the Low Cost of BAKELITE Plastics COMBINED IN CABINETS FOR RCA VICTOR

TABLE MODEL styling that is distinctive, yet priced to meet the popular demand, is now being successfully obtained by many leading manufacturers with cabinets of low-cost BAKELITE Plastics.

RCA Manufacturing Company, Inc., for example, offers a number of best-sellers in BAKELITE Plastic housings. Unusually appealing to the eye, they retain their lustrous finish and rich coloring despite frequent handling.

Listing at less than \$15.00, the attractive price of the model shown here is due in no small way to the many manufacturing economies afforded by fabricating from BAKELITE Plastics. Because cabinets such as this are molded in a single piece—complete with all decorative and constructional details—polishing, finishing, and similar operations necessary with other materials are avoided.

BAKELITE Plastics are available in many different types—Ureas, Phenolics, Polystyrenes, and Acetates—in a wide range of colorful translucent, transparent, and opaque effects. For further information write for illustrated Booklets 10M and 10P.

BAKELITE CORPORATION, 30 East 42nd Street, New York
Unit of Union Carbide and Carbon Corporation



BAKELITE

TRADE MARK
The word "Bakelite" and the  Symbol are registered trade-marks of Bakelite Corporation identifying products

PLASTICS HEADQUARTERS

"ADDS PLENTY SPARKLE"

Says
Chief Engineer

9A Pick-up plays both vertical and lateral recordings—meets highest quality standards of transcription broadcasting. Can be used on any turntable—priced within reach of all. Ask Graybar for details.

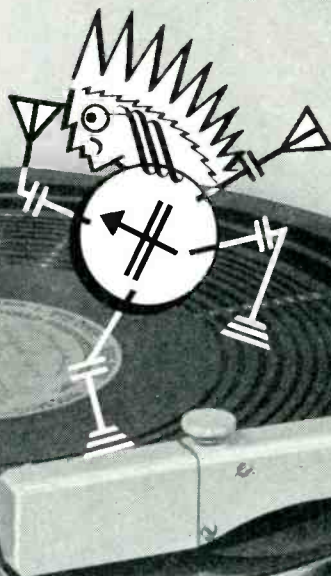

Western Electric



S. S. WHITE FLEXIBLE SHAFTS

READY for all POWER DRIVE and REMOTE CONTROL uses!

Proved in peace time service on a thousand and one different applications, S. S. WHITE Flexible Shafts are ready for any service.

POWER DRIVE shafts in diameters from .043" to .750" with companion flexible casings and end fittings for instrument drives—power take-off—portable tools—coupling of driven parts, etc. Write for Bulletin 1238.

REMOTE CONTROL shafts in diameters from .130" to .437" with companion flexible casings and end fittings for tuning radio equipment—adjusting valves, switches and other mechanisms—centralizing controls—coupling of controlled parts, etc. Write for Bulletin 38.

FLEXIBLE SHAFT COMBINATIONS for all Aircraft uses. Write for Bulletin 839.

OUR FLEXIBLE SHAFT EXPERTS are at your service on specific problems. Write us.

S. S. WHITE

The S. S. White Dental Mfg. Co.

INDUSTRIAL DIVISION

Department E, 10 East 40th St., New York, N. Y.

Type 41

PENTODE power amplifier, heater type, ST-12 glass envelope, maximum seated height $3\frac{1}{8}$ inches, 6-pin base.

$E_A = 6.3$ v
 $I_A = 0.4$ amp
 $E_b = 250$ v
 $E_c = 250$ v
 $E_c = -18$ v
 $I_b(\text{zero signal}) = 32$ ma
 $I_{c2}(\text{zero signal}) = 5.5$ ma
 $R_i = 7600$ ohms
 $P_o = 3.4$ watts (11%)
Basing 6B-O-O

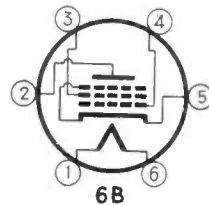

Type 50

TRIODE power amplifier, filament type, ST-16 glass envelope, maximum seated height $4\frac{1}{8}$ inches, 4-pin bayonet base.

$E_f = 7.5$ v
 $I_f = 1.25$ amps
 $E_b = 450$ v
 $E_c = -84$ v
 $I_b = 55$ ma
 $\mu = 3.8$
 $R_i = 4350$ ohms
 $P_o = 4.6$ watts (5%)
Basing 4D-O-O

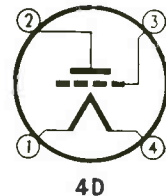

Type 75

DUPLEX-DIODE high- μ triode, heater type, ST-12 glass envelope, maximum seated height $3\frac{1}{8}$ inches, 6-pin base.

$E_A = 6.3$ v
 $I_A = 0.3$ amp
 $E_b = 250$ v
 $E_c = -2$ v
 $I_b = 0.9$ ma
 $\mu = 100$
 $r_p = 91,000$ ohms
 $\theta_m = 1100$ μ mhos
Basing 6G-O-5

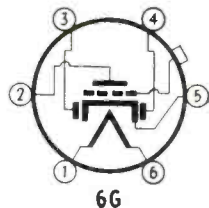

Type 82

FULL-WAVE mercury-vapor rectifier, filament type, ST-14 glass envelope, maximum seated height $4\frac{1}{8}$ inches, 4-pin base.

$E_f = 2.5$ v (ac)
 $I_f = 3.0$ amps
 $E_p(\text{max inverse}) = 1550$ v
 $E_{drop} = 15$ v (approx)
Condensed Mercury
Temperature Operating
Range $24^\circ - 60^\circ$ C.
CONDENSER INPUT TO FILTER
 $E_p(\text{rms per plate}) = 450$ v (max)
 $I_p = 115$ ma (max)
Total Effective Plate Supply Impedance (per plate) = 50 ohms (min)
CHOKE INPUT TO FILTER
 $E_p(\text{rms per plate}) = 550$ v
 $I_p = 115$ ma (max)
Minimum Value of Input Choke = 6 henries
Basing 4C-O-O

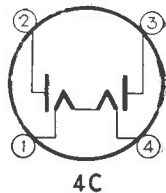

Noise in FM

(Continued from page 30)

for a signal noise ratio of 2, with the signal tuned to the high-frequency side of the pass band. This is a duplication of column 2 of Fig. 5 except that the signal is tuned to the opposite side of the pass band.

Column 2 was taken under the same set of conditions as column 1, except that a plate voltage limiter was used. The oscillograms of column 2 represent an appreciable noise reduction over those of column 1. Strangely enough, column 3, which is for a grid-leak limiter, appears to be equally good.

Perhaps it is not quite self-evident that column 2 does represent a noise reduction over column 1. This can be made clearer by referring to Fig. 8.

Frequency Spectrum of Certain Pulsations

In Fig. 8 several forms of pulsation are shown with the corresponding energy distribution curves. The first pulsation is called "unit step." The corresponding distribution curve has its amplitude inversely proportional to the frequency.

If the first derivative of the unit step is taken the result is called unit impulse. It is supposed to have infinite amplitude and zero time duration but it encloses unit area. Unit impulse has the same amount of energy at all frequencies.

If a unit impulse is applied to an ideal low pass filter, the theoretical output is $\frac{\sin 2\pi f_c t}{t}$, which is the pulsation illustrated. The energy distribution is uniform out to the cutoff frequency.

If the first derivative of this pulsation is taken, the result is the pulsation illustrated at the bottom of the figure. The energy content of this wave is directly proportional to the frequency up to cutoff.

It is apparent that many of the oscillograms representing the discriminator output are similar to one or the other of these pulsations. Now the bandwidth of a frequency-modulation receiver is 200 kc, so that from a modulation standpoint the cutoff is 100 kc. The energy con-

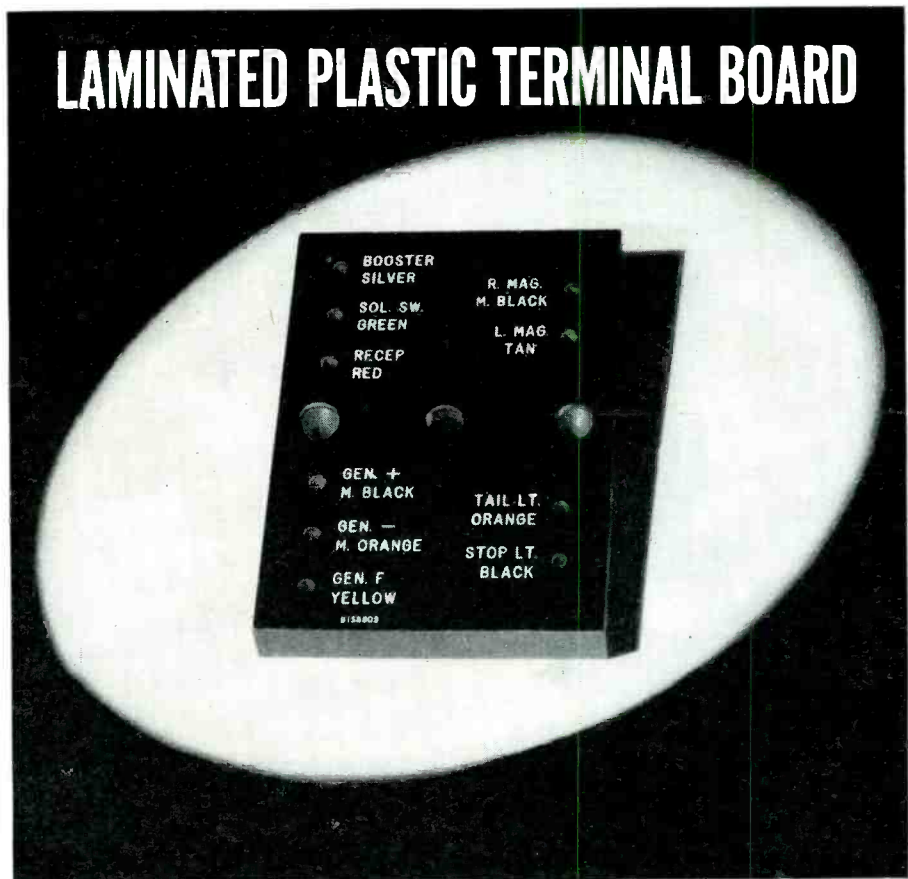

OFFERS SIX DISTINCT ADVANTAGES

One of the bright spots in modern high speed production is the increasing use of laminated Textolite plastics for insulation and structural support in a great variety of industrial applications.

One use of the material, for instance, is for terminal boards where it offers six distinct advantages:

1. Insulating characteristics
2. Good machinability
3. Light weight
4. Durability
5. Corrosion resistance
6. Good printing surface

It is difficult, as a matter of fact, to conceive of a non-plastic material meeting all these requirements. But G-E laminated Textolite is an unusual material manufactured under rigid control and fabricated to specification.

Write for our new booklet "One Plastics Avenue." Section H-25, Plastics Department, General Electric Company, One Plastics Avenue, Pittsfield, Mass.

PD-172

PLASTICS DEPARTMENT
GENERAL ELECTRIC

There is no
Substitute
for
Quality!

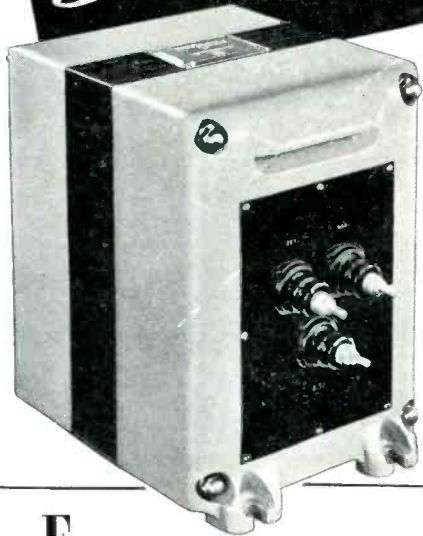

FOR forty-five years industry has recognized Thordarson to mean the best transformers obtainable. The large Thordarson staff of engineers are widely known for their ability to quickly produce special transformers to suit your application. Try this time tested engineering service plus Thordarson's quick delivery of your samples . . . for quality, specify Thordarson Transformers.

THORDARSON
Elec. Mfg. Co.

500 W. Huron St.,
Chicago, U. S. A.
TRANSFORMER SPECIALISTS SINCE 1895

tent in the audio spectrum is that represented by the shaded area in each case. It is obvious that much less energy is present in the audio spectrum of the pulsation illustrated at the bottom of the figure. One way of looking at it is that the low-frequency components of the wave tend to cancel out if the area in the pulse above the axis is equal to the area below the axis.

Theory of Improvement Due to Limiter

Referring again to Fig. 7, there are several oscillograms in column 1 which do not have equal area above and below the axis. This inequality is almost eliminated in columns 2 and 3, indicating a reduction in the low-frequency energy content. The equalization of area is to be expected from a theoretical standpoint. If the noise amplitude is less than the carrier amplitude, the resultant wave can neither gain nor lose a cycle. If no cycles are gained nor lost, then the frequency must average the same as the carrier. Thus if the limiter takes out amplitude variations in the resultant wave, the output of the discriminator must have equal area above and below the axis. Thus, a limiter does reduce the amount of noise if the carrier is detuned and if the noise is weaker than the signal. When the signal is accurately tuned in, the improvement due to the limiter takes place only on noise pulses which occur while the carrier is deviated from center by modulation.

Recommendations for Improved Performance

From the data provided by all these oscillograms, certain recommendations can be made for improving the performance of frequency-modulation receivers:

1. If the best noise reduction is to be obtained, the selectivity curve must be symmetrical and the discriminator must be accurately centered. More specifically, the overall curve through the discriminator must be symmetrical. The best noise reduction cannot be obtained if the selectivity curve is chair shaped, even if a limiter is used.

2. This symmetry must be maintained for all possible signal strengths. If automatic volume control is employed, consideration must be given to the fact that the input

capacitance of the tubes varies with bias. A large enough tuning condenser must be used on the grid circuits to make the change in tuning negligible. If automatic volume control is not used, account must be taken of the change in tuning due to grid current. Large tuning condensers should be used for any tuned circuits feeding grids that are apt to draw grid current. The degree to which symmetry has been maintained in the presence of grid current (or limitation of any kind) can best be shown by a series of oscillograms of the type of Fig. 2. The desired information cannot be obtained by means of a selectivity curve because any lack of symmetry is masked by the limiter action. The apparent selectivity curve taken point by point might appear symmetrical because of the action of the limiter in flattening the top of the curve. Under the same conditions, impulsive noise might come through at a frequency deviating from the center of the pass band, the deviation being caused by grid current which detunes one circuit during high amplitude impulses.

From further tests, not shown here, the grid-leak type of limiter seems to be particularly good in avoiding the detuning due to grid current. In fact, it seems to be the most desirable type of limiter tested, in spite of its apparent inability to remove the amplitude modulation. If Fig. 4 is re-examined keeping Fig. 8 in mind, it can be seen that the grid-leak limiter does remove the low-frequency components from the envelope of the wave. This type limiter may also be used as a source of automatic volume control voltage. It may be used in combination with the plate voltage limiter to obtain still better limiter action.

3. In the output circuit of the discriminator the two sides of the circuit must have the same fidelity characteristics. A good fidelity balance is seldom obtained in practice because the output circuit is usually grounded on one side instead of the center. As a result, there is more capacity across the grounded side than across the high side. The extra capacity can be compensated for, as shown in Fig. 1.

4. From the standpoint of noise reduction the limiter has little value, providing the circuit constants are properly balanced. The limiter helps

to reduce the noise only when the instantaneous frequency of the carrier is off center. If the signal is accurately tuned in, this means that the improvement takes place only on noise that occurs during a modulation peak. Noise which occurs only during modulation peaks is very likely to be masked by the modulation. However, the desirability of a limiter is affected by other considerations than noise reduction. For example, the limiter does reduce the distortion if the selectivity curve is not flat over the 200-kc frequency band. This may make it desirable to retain the limiter. The grid-leak type of limiter seems to be almost as effective for noise reduction as the plate-voltage limiter in spite of its demonstrated inability to remove the amplitude modulation.

A more accurate idea of the degree of usefulness of a limiter can be obtained by referring to Table I. The table at the top of the figure indicates the degree of noise reduction obtainable for relatively weak noise pulses. It indicates that the use of a limiter, and the symmetry of the selectivity curve are unimportant, providing the instantaneous frequency of the carrier wave cor-

• • •
**RADIO OPERATORS
 TRAIN FOR WAR**



The signal section of the Royal Air Force gives intensive training to young men born between 1913 and 1920 and who are destined to become radio operators. Here are two students being instructed in modern radio theory and practice at the College of Wireless and Telegraphy in Manchester

THE RELAY

THAT SURPRISED EVEN ITS DESIGNERS
**OFFERS 4 DEFINITE
 BENEFITS TO USERS**

1. Reduced user's assembly cost (relays are pre-adjusted)
2. More reliable operation (contacts have heavy pressures—are self-cleaning)
3. More positive action (armature restored by leaf spring)
4. No overheating (coil is self protecting).

You can enjoy these benefits. Write Dept. B for information.

AN OFFER . . .

Tell us (1) Your product or operation (2) Function and performance details (3) Whether chief objective is improved performance or reduced cost. We'll send a helpful recommendation, free. Write Dept. B

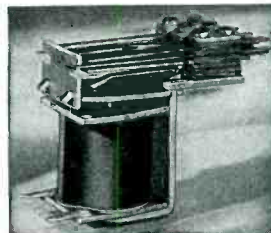

AUTOMATIC ELECTRIC

Relay Makers Since 1898

1033 West Van Buren Street, Chicago

CONSTANT LABORATORY CHECK on RAW MATERIALS
 is only **ONE** of HUDSON WIRE'S TESTS for **QUALITY**

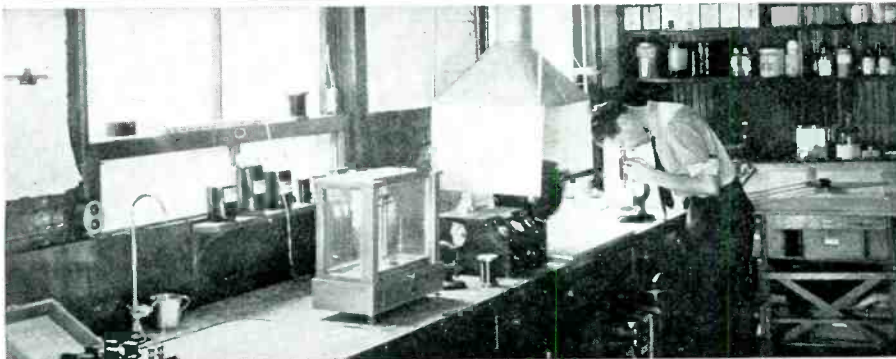

You are assured of a constant source of wire that always meets or exceeds your specifications when it comes from the Winsted Division of Hudson Wire Co. Continual checking and testing from the raw material stage through the exacting control processes guarantee the perfect uniformity you need. And with Hudson Wire's new coating method that adds great dielectric strength you are certain of getting the finest enameled wire available.

Our engineering and design facilities are at your disposal—details and quotations on request.

HUDSON WIRE COMPANY
Winsted Division

WINSTED

CONNECTICUT



Complex...?
YES!

Costly...?
NO!

Sheet Metal Fabrications
Stamping
Machine Work
Electrical Assembly
Wiring and Testing
Welding
Paint Finishing
Products Completely Manufactured

50
YEARS
EXPERIENCE

This picture shows you the general character of electrical wiring and assembly work that we are doing on contract for some of the biggest firms in the country. This unit was a very complex job. But, with the exceptionally wide range of facilities, men, materials and experience that this organization was able to put to work, this unit was produced in a first class manner, very quickly and at low cost.

LEWYT METAL PRODUCTS CO. Inc.
60 Broadway
Brooklyn, N. Y.



responds to the frequency of zero output at the center of the discriminator curve. It also indicates that if the frequency of the carrier wave has a slightly different value, the limiter is of importance, but a symmetrical selectivity curve is still not necessary.

The table at the bottom of page 27 is for relatively strong noise pulses. It indicates that for this condition the limiter is useful only when the overall selectivity curve has poor symmetry. That portion of the noise pulse which is greatly in excess of the carrier level may be removed about equally well by the limiter or by the symmetry of the selectivity curve.

In the table it is assumed that the detuning due to grid current is negligible. If suitable precautions are not taken so that grid current does cause detuning, then the use of the limiter may make the noise worse.

Operating tests with commercial frequency-modulation receivers have shown that ignition noise from passing cars is often a limiting factor in reception. It is believed that careful attention to the points outlined will materially reduce noise of this kind.

The author wishes to acknowledge with thanks the help of Messrs. R. A. Felmley, H. L. Daniels and W. P. Bollinger who assisted with the experimental work leading to this paper.

¹ M. G. Crosby "Frequency-Modulation Noise Characteristics", *Proc. I.R.E.* Vol. 25, April 1937, No. 6, p. 472.

• • •
**FOR "BOOTLEG"
BROADCAST STATIONS**



Interior of the special radio monitoring car operated by the F.C.C. to ferret out by radio direction methods, transmissions from illegal radio stations. Copies of illegal transmissions may be made on the recording device shown above the nearer communications type receiver

INSUROK

Precision Insulation for Automatic Telephone Systems

Illustrated is the contact bank assembly of Automatic Electric Company Strowger Switches — the standard and basic mechanism of almost all their automatic telephone systems.



Because the line contacts in this bank are so close together, the dielectric qualities of the insulating strips are especially important. Precision Laminated INSUROK is the plastic chosen by Automatic Electric Company for this vital insulation requirement to assure continuous, trouble-free, superior performance.

Somewhere in your product or in your production equipment INSUROK, the Precision Molded and Laminated plastic, may be used to profitable advantage. Consult Richardson Research, Design and Engineering staffs . . . without obligation . . . about any plastics problem.

The RICHARDSON COMPANY

MELROSE PARK, (CHICAGO) ILL. FOUNDED 1858 LOCKLAND, (CINCINNATI) OHIO
NEW BRUNSWICK, N. J. INDIANAPOLIS, IND.
DETROIT OFFICE: 4-252 G. M. BUILDING, PHONE MADISON 9586
NEW YORK OFFICE: 75 WEST STREET, PHONE WHITEHALL 4-4487

THE ELECTRON ART

Electron paths in multi-element tubes, a 50-kw transmitter with push-button tuning, a d-c amplifier with high current output, frequency range of receivers and a push-pull amplifier for ultrahigh frequencies are reviewed this month

Paths of Electrons in Multi-Element Tubes

TUBE ENGINEERS ARE CONSTANTLY STRIVING for methods to improve the product they manufacture or design, and much time and effort has been spent in devising means of studying and improving the operation of electron tube devices. An article in this direction is published by J. H. L. Jonker, in the May, 1940, issue of the *Phillips Technical Review* under the title "Electron Trajectories in Multi-Grid Valves."

In this study, Mr. Jonker points out that in the case of tetrode and pentode the plate current increases rapidly with increasing plate voltage and reaches a saturation value at a voltage of between approximately 20 and 40 volts. In order to make the best use of the capabilities inherent in the tube design, it is desirable to make the saturation plate voltage as low as possible. For this purpose, care must be taken that the electrons are not too much deflected by the wires of the various grids in the multi-element tubes. The deflection of electrons by grid wires and the influence of this deflection on the plate characteristics of pentode and tetrode are examined theoretically and experimentally.

In studying the trajectories of electrons in a suitable field by means of the rubber membrane technique, photographs were made by intermittent (stroboscopic) light and showed the effects of a series of balls rolling on a rubber sheet. From an analysis of this diagram it is shown that the tangent of the angle of deflection of the electron is almost directly proportional to the distance from the mid-center of the grid interstices. This is to say that the electrons at the midpoint between two grid wires are essentially non-deflected whereas the deflection increases the closer the electron beam comes to the grid wires themselves. From such photographs, supplemented by mathematical analysis, it is shown that for low plate voltages, the plate current for a given screen voltage is proportional to the square root of the plate voltage. For this condition, the plate circuit characteristic has a kink, and then continues horizontally with increasing voltage. Additional deflection of the electrons by the sup-

pressor and control grid (rather than the screen grid alone) causes the plate current to reach the maximum value with increasing plate voltage later than would follow from the statement just given, in which consideration was given to a single grid. Furthermore, because of these additional deflections, the shape of the plate characteristics is very much altered in the neighborhood of the knee or bend in the tetrode characteristic.

By studying the effects of trajectories for grids having negative potentials, it is shown that due to the repellent action of the grid, the deflection is in a direction opposite to that which appears when the grid is positive. Thus, a beam of electron rather tends to be focused instead of spread.

The article continues the theoretical and experimental verifications of electron trajectories, stresses the effects

of the control grid, the screen grid and the suppressor grid, shows the plate characteristics which are calculated for electron beams scattered according to velocity diagram which are given for tubes having one, two or three grids, and concludes by showing a diagram comparing an early type of pentode with its modern counterpart. In this comparison, the knee of the curve for the modern tube is much more sharply defined than for the old tube and occurs at a plate voltage of about 20 volts instead of approximately 40 volts for the older tube.

• • •

50 kw Transmitter with Push-Button Tuning

THE JANUARY 1941 ISSUE of *Electrical Engineering* contains an article by R. J. Rockwell and H. Lepple describing "A Push-Button Tuned 50-kw Broadcast Transmitter." The paper describes the use of an automatic push-button tuning system on shortwave broadcast transmitters which are required to change from one frequency to another with the least possible interruption. The transmitter is designed to operate on any one of eight different frequencies. After the proper preliminary adjustments are made, the entire transmitter can be changed to any one of the eight frequencies by simply pressing the proper button.

The radio frequency section of the transmitter described, that of WLWO,

CYCLOTRON TO BE BUILT IN INDIA

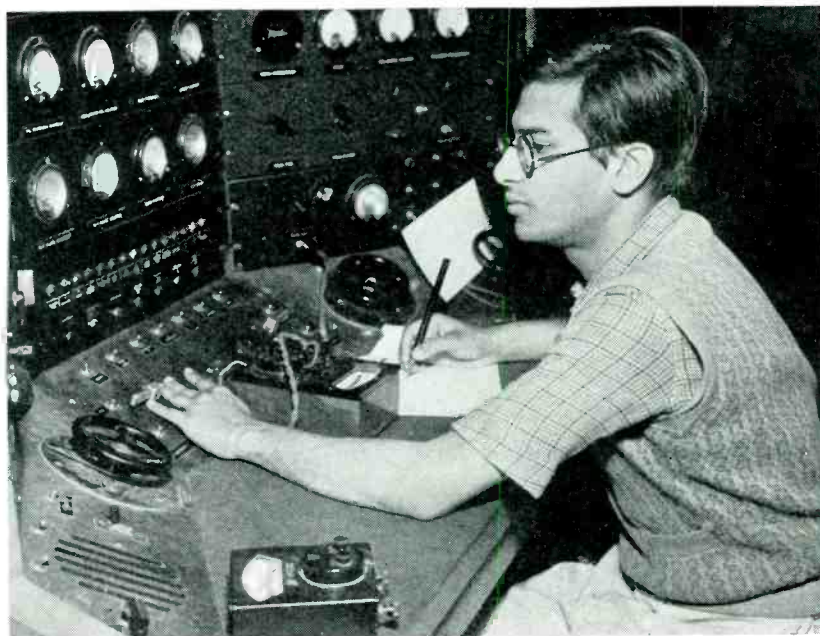

Basanti Dulal Nag Chaudhuri of Benares, India will shortly return to his native land to apply his two years study in the radiation laboratory of the University of California toward the building of a cyclotron. He will work with Dr. M. N. Saha at the University of Calcutta. Here he is shown at the controls of the cyclotron at the University of California

Presto Offers a New 50 Watt Recording Amplifier . . .

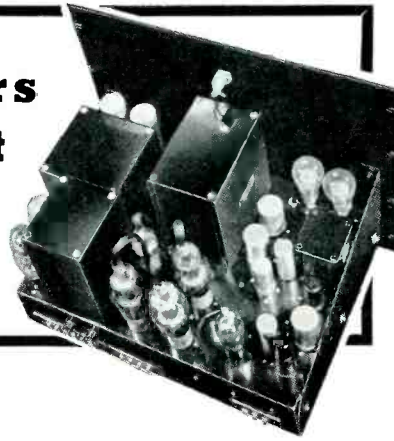

. . . and the first *accurately calibrated* recording channel for making direct playback transcriptions. The new Presto 88-A amplifier, combined with the Presto 1-C cutting head, makes recordings identical in response to the finest commercial pressings. These recordings give you full range reproduction when played back on the N. B. C. Orthacoustic or standard lateral settings of your reproducing equipment. A switch on the amplifier selects either of the two recording characteristics.

You'll hear a new quality in your recordings when you use this Presto equipment . . . a fuller, more

natural bass . . . crisper, cleaner highs. Pre-emphasized high frequency response reduces surface noise well below audibility. Output of the 88-A is 50 watts with 1½% distortion. Gain is 85 db. Noise level is 45 db below zero (.006 W). Use the 88-A in place of your present amplifier. You'll notice a tremendous improvement in your recordings. Your present Presto 1-B or 1-C cutter can be calibrated with an 88-A amplifier at a nominal charge. Catalog sheet on request.

Canadian Distributor: Walter P. Downs, 2313 St. Catherine St. W., Montreal, P. Q.

PRESTO RECORDING CORPORATION
242 West 55th Street, New York, N. Y.
World's Largest Manufacturers of Instantaneous Sound Recording Equipment and Discs

STABILIZED A. C. VOLTAGE UP TO 25 KVA

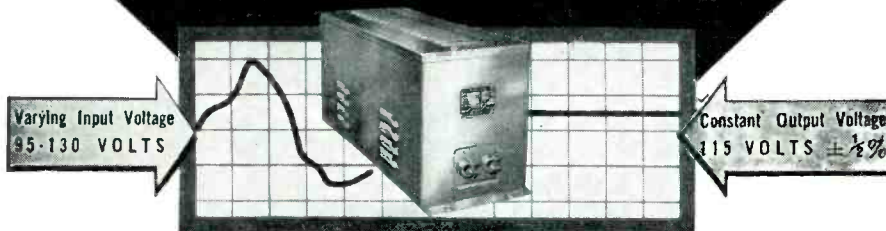

INSTANTANEOUS ACTION

NO MOVING PARTS

When a precision electrical device or a critical process is powered from an AC line, a Raytheon Voltage Stabilizer will permanently eliminate all of the detrimental effects caused by AC line voltage fluctuations. Made for all commercial voltages and frequencies, single or three phase.

Raytheon's twelve years of experience in successfully applying the Stabilizer to hundreds of perplexing voltage fluctuation problems is at your service. It will pay you to take advantage of our engineering skill.

Write for Bulletin DL48-71 JE describing Raytheon Stabilizers.

RAYTHEON MANUFACTURING CO.
100 Willow Street, WALTHAM, Massachusetts

consists of three units: (1) a 1-kw amplifier mounted on a single chassis, (2) a 5-kw amplifier and (3) the final amplifier of 50-kw rating.

For the 1-kw unit, the grid and plate coils are small and a separate set of coils and condensers is used for each frequency. These are mounted on a drum which is rotated by a motor until the proper tuning circuits make contacts with the set of six wipers. The eight crystals are mounted separately and are kept at operating temperatures at all times. When the drum rotates to bring into position the coils for a particular frequency, it also makes connection to the crystal for that frequency.

The plate coil of the 5-kw stage and the grid coil of the 50-kw stage are too large to employ the preceding method of tuning. These circuits are consequently tuned by means of motor driven wipers mounted on a shaft which runs through the center of the coil. The wipers, which are motor driven, short circuit a fixed number of turns of the coil depending on the frequency to be used. The rotating drum and wipers may also be rotated by a hand wheel mounted on the front of the transmitter cabinet.

In tuning the 50-kw amplifier a number of unusual difficulties are experienced which do not show up in the low power stages. This final amplifier makes use of a transmission line designed to present the proper load

X-RAY TUBE FOR INDUSTRIAL ANALYSIS

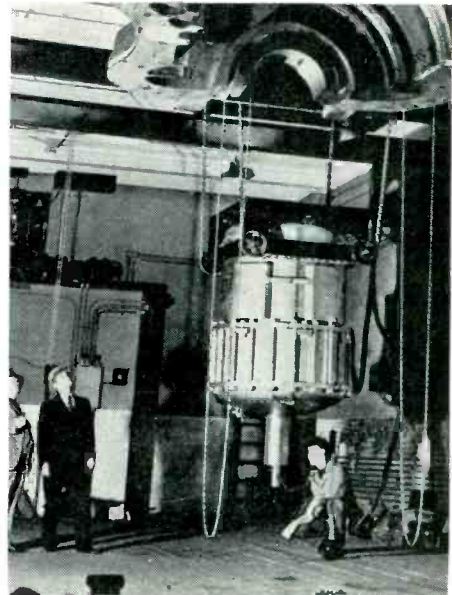

The tube shown above, in G.E.'s powerful industrial x-ray laboratory at Schenectady, produces energy equivalent to that produced by ninety million dollars worth of radium. The tube will be used to examine large castings and to protect against flaws in steel

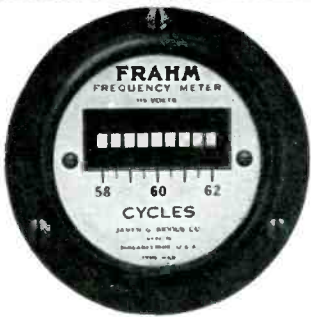

A Dependable MINIATURE FREQUENCY METER

FOR POWER FREQUENCIES — BETWEEN 15 AND 500 CYCLES PER SECOND

Frahm Frequency Meters indicate by the resonant vibration of accurately tuned steel reeds, which hold their original calibration for a very long time. Simple. Rugged. Unaffected by wave form or by ordinary voltage and temperature changes. Wide range portable and switchboard types also available.

Write for Bulletin 1555-E

JAMES G. BIDDLE CO.

ELECTRICAL INSTRUMENTS
1211-13 ARCH STREET PHILADELPHIA, PA.



"Mangrid"
GRID WIRE

Economy
with quality

"Mangrid"
made only by

WILBUR B. DRIVER CO.
NEWARK, NEW JERSEY

impedance to the final amplifier and also to couple the antenna load to the transmitter. Consequently the transmission line, as well as the grid and tank circuits, must be modified for various frequencies. This is accomplished by switching across the transmission line at the proper point a condenser of such capacitance as to obtain the desired coupling. Since there are eight frequencies, there will be eight stations along the transmission line, each of which consists of its own group of vacuum condensers which may be swung into contact with the transmission line by the properly operated motor. It is also necessary to tune the various tank circuits in addition to matching the antenna to the transmission line for each frequency. Contact wipers which are motor driven, and accomplish this purpose, are similar in principle to those used in the low power stages although the details are considerably different.

Five operations are required to retune the transmitter. These are as follows: (1) the drum on the low power chassis must rotate to the proper set of coils, (2) the wipers on the 5-kw tank coil and (3) the wipers on the grid coil of the 50-kw stage must be moved to a new position, (4) a different capacitor station along the transmission line must be swung into position, and (5) the antenna must be matched to the transmission line. An eight-position motor control unit is required to effect all of these operations in the proper sequence. The circuits are so arranged, however, that once the adjustments for all eight frequencies are made, tuning for any one of the eight frequencies may be obtained automatically merely by pushing the appropriate push-button.

The details for the complete push-button tuning system for a high power transmitter are given by the authors.

• • •

D-C Amplifier with High Current Output

WRITING IN THE DECEMBER, 1940 ISSUE of the *Review of Scientific Instruments*, S. M. Trevino and Macklin Offner describe, "An A-C Operated D-C Amplifier with Large Current Output," specifically designed to operate a string oscillograph requiring approximately 125 ma for full scale deflection, from a frequency meter having an output of 7 volts. With an input voltage of from 0 to 8, the output current varies from approximately -90 ma to +90 ma.

The difficulty of obtaining large current output with good linearity, and the undesirability of fluctuations in the current demand, led the authors to the selection of a push-pull amplifier which has the further advantage of eliminating even harmonics generated in the stage itself. Since a balanced push-pull amplifier is coupled to a single-ended source, a phase inverter is also incorporated in the unit.

The analysis given by the authors

Heavy-duty
OIL-FILLED
Capacitors



Here are two recent additions to the Hyvol transmitting Capacitor line, to meet the higher voltage requirements of cathode-ray tube supplies, by-pass circuits in transmitters, high-power rectifiers, PA-systems and so on. Type -12 (left) provides high-voltage pillar terminals in minimum height, due to separator ribs. Type -14 (right) has single pillar-insulator terminal for maximum insulation between live terminal and grounded can. Both are immersion-proof. Both with adjustable mounting ring.

Type 12—2 1/4" dia. Can				
Can Height in Inches				
Mfd.	2000 v.	3000 v.	4000 v.	6000 v. 7500 v.
.01	3 1/4
.02	2 3/4	3 3/4
.03	...	2 1/4	2 3/4	3 3/4
.05	...	2 1/4	3 3/4	4 3/4
.1	...	3 1/4	5 1/4	...
.25	...	3 3/4
.5	3 3/4	5 1/4
1.0	5 1/4
2.0

Type 14—1 3/8" dia. Can.	
3000 v. D.C. Working	
Mfd.	Height in Inches
.01	2 1/4
.05	2 1/4
.1	2 3/4

Write for DATA . . .

Our Transmuting Capacitor Catalog, available solely to professional radio men, lists these and other Hyvol capacitors. Also heavy-duty commercial-grade mica, paper, oil and plug-in electrolytic capacitors. Write on business letterhead for your copy.

AEROVOX
CORPORATION
NEW BEDFORD, MASS.
IN CANADA: AEROVOX CANADA, Limited Hamilton, Ont.

PINCOR PRODUCTS FOR AIRCRAFT SOUND and other POWER SUPPLY USES

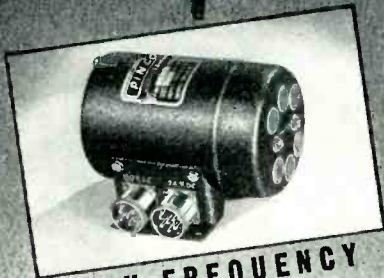

HIGH FREQUENCY CONVERTERS

Pincor High Frequency Converters are precision built for smooth, silent, dependable performance. 5 to 500 watts, 400 and 500 cycles. Special units designed to meet any output or requirements.

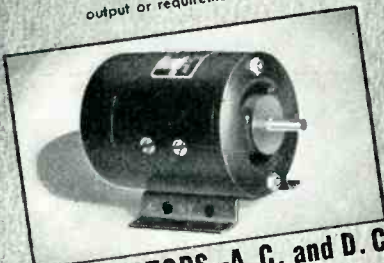

SMALL MOTORS—A. C. and D. C.

These small motors are particularly adapted for band switching, remote control, etc., for aircraft use or wherever a small light weight motor is required for unflinching service. 20 watts output. Others as required.



DYNAMOTORS

Pincor Dynamotors afford a dependable "B" power supply for aircraft, marine and broadcast service, mobile units, etc. Highest efficiency and regulation. 5 to 850 watts. Input 6 to 110 volts; output up to 1750 volts.

Write or Wire for Information

PIONEER GEN-E-MOTOR CORPORATION
CHICAGO, ILLINOIS

Export Address: 25 Warren St., N. Y., N. Y.
Cable: Simontrice, New York

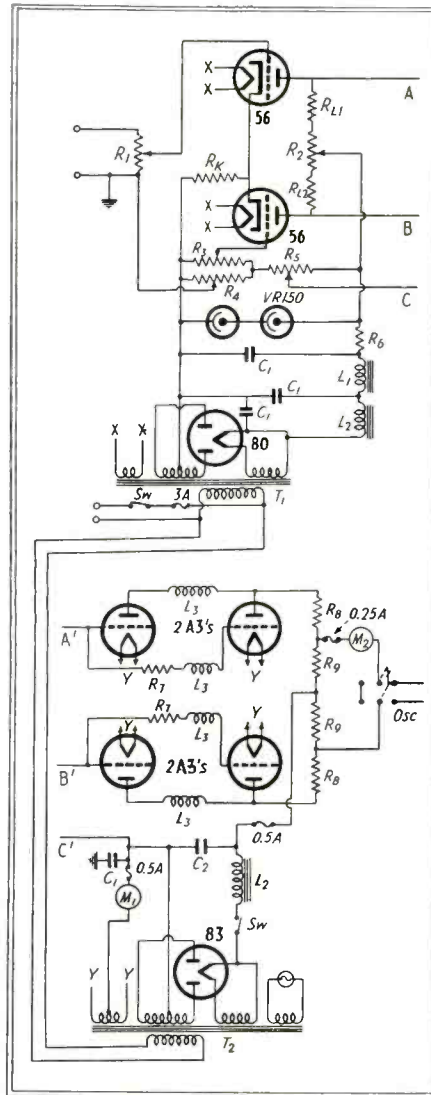

Circuit diagram of the d-c amplifier.
The points A, B and C are connected to A', B' and C'

shows that it is desirable to use two identical tubes for the two sides of the push-pull circuit, but that the plate loads of the two tubes must not be equal, if the benefits of degeneration are to be obtained. The plate circuit loading of the tube to which the input signal is applied should be less than that for the remaining tube and it is shown that for proper design balance is not dependent upon the amplification factor or the plate resistance of the tube to which the input signal is applied.

As shown in the accompanying diagram, the amplifier consists of a two-stage unit. The first stage which incorporates the stage inverter is composed of two type 56 tubes and their associated circuits. The output or driving stage contains four 2A3 triodes. Two tubes in parallel are used on either side of the push-pull circuit. The grids of the output tubes are coupled directly to the plate of the inverter tube. Parasitic oscillations in the output stage are eliminated by the inclusion of radio frequency choke coils in the grid and plate circuits of the tubes. The desired oper-

ating bias for the 2A3's is obtained by connecting the negative of the output stage power supply to a sufficiently negative point on all sides, the voltage divider of the inverter power supply, in order to cancel in part the voltage drop in R_{L1} and R_{L2} . The output circuit consists of two 500-ohm load resistors, R_8 to improve linearity of response, and two 100-ohm oscillograph coupling resistors, R_9 . Two separate power supplies are provided. That feeding the inverter stage is maintained constant through the use of two VR150 voltage stabilizers.

The authors give a procedure for the proper adjustment of the amplifier and state that in operation, the frequency response of the amplifier is linear to within ± 1 db up to 10,000 cps. Fluctuations in the line voltage affect the operation of the amplifier slightly. A ± 5 per cent voltage variation produces a maximum gain of 3 ma in the differential plate current, although this may be reduced by additional power supply regulation, especially for the unit supplying the output stage. Although there is some tendency to drift, the amplifier becomes stable after about an hour.

To fit the diagram into a single column cut, the amplifier circuit given by the authors is divided into two sections incorporating the inverter stage, and the output stage as two separate units. In practice, of course, the points A and A' should be connected together as should also B and B', as well as C and C'.

WABC UNDER CONSTRUCTION



This Fairchild Aerial Survey photograph shows the construction of foundations for the new WABC station at West Pea Island in Long Island Sound

Frequency Range of Radio Receivers

A DISCUSSION OF THE FREQUENCY range of a radio receiver and the method of attaining that range are presented in an article by L. V. Cohen Henriques in the April 1940 issue of the *Phillips Technical Review*. The author first discusses the various types of interference produced in a receiver by a transmitter on a channel adjacent to

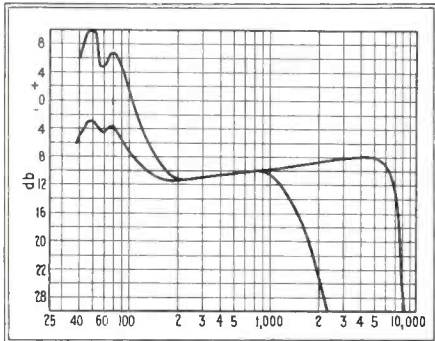

Fig. 1—A desirable frequency characteristic for a receiver according to the author

that of the desired signal. These types of interference are cross talk, a crackling effect known as sideband splash or chatter, and a heterodyne whistle. Also discussed are the restrictions imposed on the low frequency by the loudspeaker and the cabinet. Figure 1 represents the author's idea of what the frequency characteristic of a radio receiver should be. These characteristic curves involve a rapid attenuation of high frequencies above a certain point. To obtain this high frequency cut-off a two-stage audio amplifier with variable inverse feed-back is described and its circuit is shown in Figs. 2 and 3. The voltage from the output of an amplifier is conducted via two channels to the cathode of the first

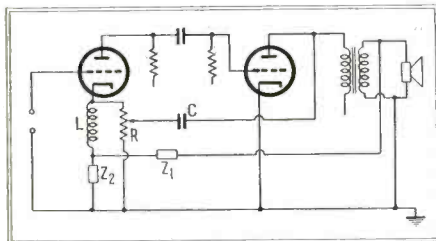

Fig. 2—Simplified circuit of the variable inverse feedback amplifier

tube. The first of these channels is from the secondary of the output transformer via C_1 and C_2 and the second channel is from the primary side of the output transformer via C , R , L and C_2 ; although the voltage on the primary of the output transformer is much greater, at low frequencies only the inverse feed-back of the secondary side is effective because the condenser C passes practically no current. The inverse feed-back voltage of the

ELMET

MOLYBDENUM TUNGSTEN AND ALLOYS

FOR THE ELECTRONICS INDUSTRY

AMERICAN ELECTRO METAL CORPORATION

Research Laboratory and Offices: 320 YONKERS AVE., YONKERS, N. Y.
Factory: LEWISTON, MAINE

Cable Address: Cutanit Yonkers NewYork Telephone: Marble 7-9511

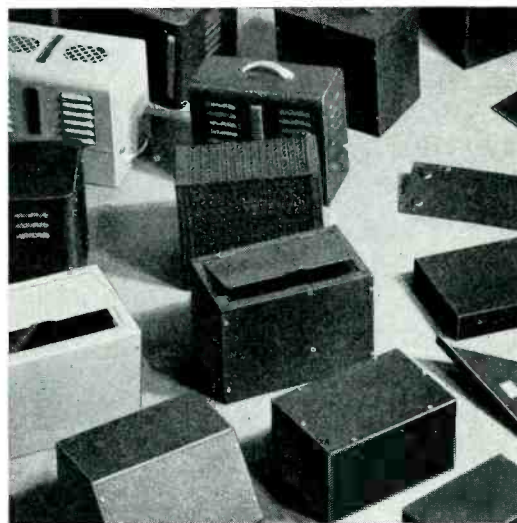

Always
Specify
BUD
SHEET
METAL

Make it a habit to rely on BUD for your sheet metal requirements. CABINETS, RACKS, CHASSIS, PANELS . . . everything necessary for industrial electronic applications and commercial station installations. There are hundreds of stock items designed for peak performance under all conditions . . . or spe-

cial items accurately built to your exact specifications.

Send us your blue-prints for prompt quotations. Write for your copy of our latest catalog. It describes the complete BUD line which includes Condensers, Coils, Chokes, Insulators, Plugs and many other specialties.



BUD RADIO, INC.

CLEVELAND, OHIO

DON'T BUY ANY RESISTOR

until you investigate the *Globar* Ceramic Resistor

● Your choice of a resistor is important. That's why you should find out all about Globar Brand Ceramic Resistors that are serving industry in so many different ways.

They are non-inductive, chemically stable, mechanically strong... and available in a wide selection of types, shapes, sizes and characteristics.

If you are faced with any kind of resistor question, the service of Globar engineers is yours for the asking. Simply write for Bulletin R and give us details of your requirements.

GLOBAR DIVISION
THE CARBORUNDUM COMPANY, NIAGARA FALLS, N. Y.

REG. U. S. PAT. OFF.

(Globar is a registered trade-mark of The Carborundum Company)

Globar CERAMIC RESISTORS

With business on the march

YOU NEED THIS FINER INSTRUMENT

ELECTRICAL instruments that are not absolutely reliable—that do not stay accurate under increased production loads—just don't fit in today's picture.

Simpson Instruments do. They offer you the basically-better Simpson movement—a full bridge type movement with soft iron pole pieces. You get not only greater initial accuracy, but accuracy that will be maintained despite hardest service.

Entirely out of keeping with Simpson quality are the moderate prices of Simpson Instruments. Only long experience and efficient methods of instrument manufacture can make such remarkable values possible.

Write for complete literature

SIMPSON ELECTRIC COMPANY
5212 Kinzie Street, Chicago, Illinois

SIMPSON
INSTRUMENTS THAT STAY ACCURATE

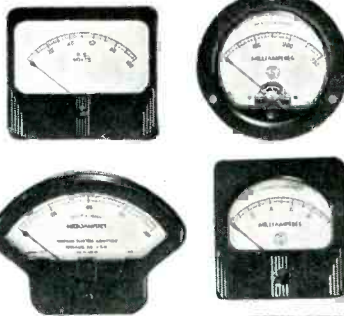
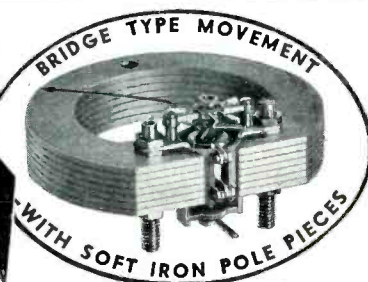

HERE'S AN IDEA

● Use Simpson's nine Micro-Testers, the original line of small, uniform-size testers, to supplement crowded testing facilities. Model 280, A.C. Ammeter, shown here, covers five separate ranges, yet—typical of Simpson value—costs only\$9.75

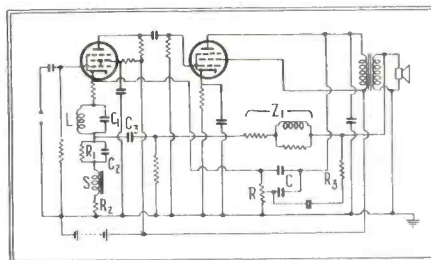

Fig. 3—Circuit diagram of the complete amplifier

secondary is divided between the impedances C_1 and C_2 which are so chosen that the strength of inverse feed-back gradually increases with increasing frequency. The inverse feed-back along the second branch is, however, always more effective with increased efficiency.

In order to control the variation of high frequency attenuation the resistance R is supplied with a sliding contact. When the contact is at the lowest point, the feed-back current through C flows directly to ground, so that there is no inverse feed-back.

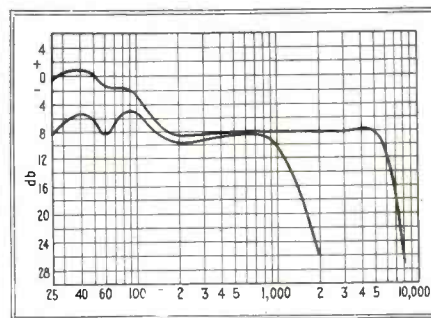

Fig. 4—Frequency characteristic of the amplifier shown in Fig. 3

When the contact is at the highest point, the inverse feed-back is at a maximum and practically its entire current flows through L and Z_1 , since the impedance of this connection to ground is always less than R . Figure 3 shows the complete diagram of the variable inverse feed-back amplifier and its frequency characteristic is shown in Fig. 4. Note that the curve of Fig. 4 closely approximates that of Fig. 1.

• • •

Cathode Ray Tube Illustrates Polarized Light

THE FUNDAMENTAL PROPERTIES of elliptically polarized light may be illustrated by means of comparatively simple demonstration equipment in which a cathode ray tube figure as the essential element. The method for using the cathode ray tube for this purpose has been described by L. R. Steinhardt in the November issue of the *DuMont Oscillographer*.

Merely by manipulating through controls on the oscillograph, it is possible to produce screen patterns representing every possible state of polar-

NEW TERMINALS With Wide Range Utility

No. 140 SERIES



140

$\frac{3}{4}$ " wide and
 $\frac{13}{32}$ " high.
2 to 21 ter-
minals.
5-40 x $\frac{3}{16}$ "
screws.

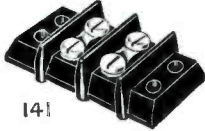

141

$1\frac{1}{4}$ " wide x $\frac{1}{2}$ "
high.
2 to 20 ter-
minals.
6-32 x $\frac{1}{4}$ "
screws.

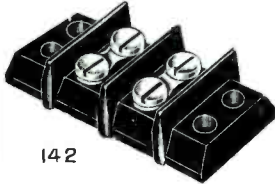

142

$1\text{-}5\frac{1}{16}$ " wide x
 $\frac{5}{8}$ " high.
2 to 17 ter-
minals.
8-32 x $5\frac{1}{16}$ "
screws.

Made in three sizes as shown above. Barrier strips not only make a long leakage path, but prevent direct shorts from frayed wires at terminals. Molded bakelite insulation.

Terminals, Terminal Panels, Plugs, and Sockets made to your specifications.

Write for prices
and samples.

HOWARD B. JONES
2300 WABANSIA AVENUE,
CHICAGO ILLINOIS

HAVE YOU HEARD?...

... that the Carter Motor Company has purchased the MAGMOTOR RADIO POWER SUPPLY DIVISION from the American Bosch Corporation of Springfield, Mass. All patents covering permanent magnet Dynamotors together with tools, dies, patterns, and trade marks, become the property of the Carter Motor Company.

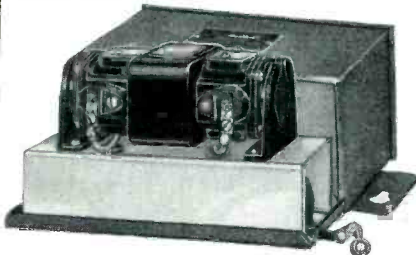

The MAGMOTOR, now available for general use, is unique in principle. The conventional field coils are replaced with Alnico permanent magnets. This exclusive feature increases efficiency, reduces size and weight, and eliminates heat. Brush life has been increased to over 5000 hours of continuous service. Carter is now the sole manufacturer of permanent magnet Dynamotors.

Write today for descriptive literature.

Carter Motor Co.
CHICAGO ILLINOIS

1606 Milwaukee Ave. Cable: Genemotor
Carter, a well known name in Radio since 1922

ization of radiation such as light or ultrahigh frequency radio waves. These three controls correspond to the three basic elements of a general ellipse—the amplitude of the two perpendicular components, and the phase relation between the two components. Any one of these three components can be varied singly and at will by means of a cathode ray tube oscillograph, so that the various concepts associated with plane, elliptically, and circularly polarized waves can be made readily apparent to the student.

A Push-Pull Amplifier for Ultrahigh Frequencies

IN THE *Phillips Technical Review* for June, 1940, M. J. O. Strutt and A. van der Ziel describe "A New Push-Pull Amplifier Valve for Decimeter Waves." In this article the authors show that for the reception of signals with wavelengths shorter than 1 meter, electron tubes are needed which have a desirable input and output damping, low equivalent noise resistance, and a high transconductance. While the acorn tetrode satisfies the first requirement, it does not adequately fulfill the requirements for the latter two cases. Although the latter two requirements may be satisfied with electrode systems having larger dimensions, so that the requirements appear to be mutually exclusive.

The input and output damping of such systems can be considerably lowered by connecting two elements in the push-pull circuit in a suitable way. An explanation of the construction of a push-pull amplifier tube, developed on this principle, is given and the possibility of its employment is described. In particular, a discussion is given of the results which can be obtained upon application of the tubes in amplifying and mixing stages.

MUSIC SOOTHES



To soothe bomb-shocked nerves, transcribed records are played over the loud speaker system of a London railroad station when train announcements are not being made



**The best value
in communications
Receivers**

MODEL SX-25. Embodies every worthwhile advancement. 12 tubes—2 stages of preselection—tunes from 540 kc. to 42 mc. in 4 bands—ANL—6 step variable selectivity to extreme CW crystal—10 inch heavy duty PM dynamic speaker—110 volt 50-60 cycle AC. (DC operation socket provided for battery or vibrapack.) Model SX-24 represents the best value in the communications field. 9 tubes—4 bands—frequency range from 540 kc. to 43.5 mc.—single-signal crystal filter standard equipment. DC operation socket—battery or vibrapack.

the hallicrafters co.
CHICAGO, U. S. A.

USED BY 33 GOVERNMENTS
SOLD IN 89 COUNTRIES



AC and DC VOLT-OHM-MILLIAMMETER



MODEL 666



Pocket Size: 3 1/8" x 5 7/8" x 2 1/8"

\$14.00 Dealer Net Price

This Pocket Size Volt-Ohm-Milliammeter is a complete instrument for all AC-DC Voltage, current and resistance analyses. Has 3" Square Triplet improved rectifier type instrument. AC-DC Voltage scales read: 0-10-50-250-500-1000 at 1000 ohms per volt. DC Milliampere scales read: 0-1-10-50-250. Ohms scales read: Low 1/2-300; High 250,000. Resistance range can be increased by adding external batteries. Low loss selector switch. Black molded case and panel . . . completely insulated. RED DOT Lifetime Guaranteed Measuring Instrument. Alligator Clips, Battery and Test Leads included . . . Dealer Net Price . . . \$14.00.

Model 666-H . . . same as Model 666 but with AC-DC Voltage ranges to 5000 volts (self-contained) . . . \$14.50 Dealer Net Price.

MODEL 625

NEW Precision Portables
Clear Readability
Models 625 (DC Moving Coil Type) 635 (AC Movable Iron Vane Type) and 665 (Electro-dynamometer Type)
Have mirror scales and knife-edge pointers . . . Scale length 4.88" — Accuracy within 1%.
Black molded case
6" x 5 1/2" x 2 1/2".



Triplet also has available a complete line of panel instruments, radio and industrial test equipment.

WRITE FOR CATALOG—Section 232 Harmon Avenue

THE TRIPLET ELECTRICAL INSTRUMENT CO.
Bluffton, Ohio

An Integrating Voltmeter

IN THE DECEMBER ISSUE of the *Review of Scientific Instruments*, Edmond Jacobson describes "An Integrating Voltmeter for the Study of Nerve and Muscle Potentials." According to the author, the integration neurovoltmeter consists of a vacuum tube rectifier for causing the amplified action potential to charge a condenser in such a way that the magnitude of the charges is a measure of the average action

is the important unit so far as conception of new ideas is concerned, is shown in the figure. The amplified input voltage is applied to the Western Electric Type 262B triode used as a rectifier, which is connected to a 0 to 30 microammeter. The current output from the rectifier flows to the microammeter and about 97 per cent of this passes through the one megohm resistor. Consequently, for practical purposes the potential effectively charging the condenser is the product of the current in the microammeter multiplied by 10^6 . The rectified voltage to charge a condenser is calculated and at the end of the charging period the condenser is discharged by pressing a button that connects the galvanometer directly across the condenser. The deflection of the galvanometer can be taken as a measure of the desired voltage.

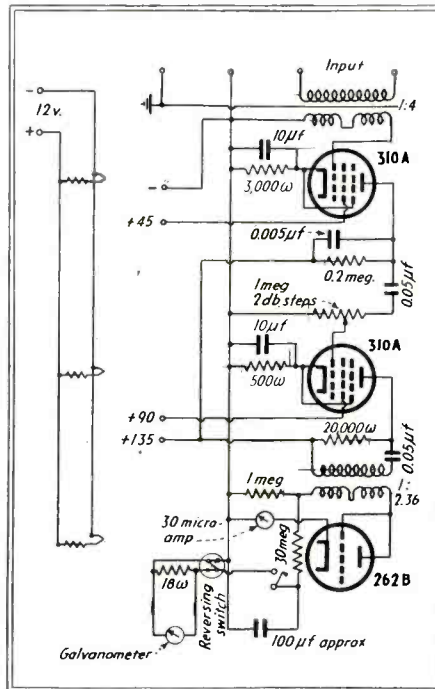

Circuit diagram of the integrating voltmeter

potential. This is accomplished by connecting a high resistor in series with the rectifier and condenser, thereby reducing the charging rate to such an extent that the voltage across the condenser always remains small in comparison with the rectified voltage. The condenser and resistor circuit is shunted by the second resistor considerably less than the charging resistor, but still large in comparison with the needs of the rectifier and rectifier input circuit. This assures that the total rectifier output will be proportional to the input voltage and permit the use of a meter to indicate the total rectifier output as in the neurovoltmeter previously described by the author in 1937.

The integrating neurovoltmeter consists of two units. The first is an amplifier of conventional design and suitable for developing an output of about 3 millivolts. The second unit consists of a two-stage resistance-capacitance coupled amplifier with transformer input and output and followed by the rectifier and other equipment for integrating the voltage.

The circuit of the second unit, which

I.R.E. Meeting

(Continued from page 25)

mitter is intended for commercial use. Its development was outlined and the reason behind certain of its design features were explained.

Frequency Modulation

A study of the "Intermediate Frequency Values for Frequency-Modulated-Wave Receivers" was described by D. E. Foster and Garrard Mountjoy of the RCA License Laboratory. The problem was investigated from the standpoint of gain, bandwidth, stability, economy, and freedom from spurious response. Several points of difference with receivers for the standard broadcast band were pointed out. By a proper distribution of impedance in the circuit it was shown that high gain could be obtained with good stability and economy of manufacture. The effects of the intermediate frequency upon this distribution were also described. The influence of the several types of spurious response upon the selection of the intermediate frequency was discussed. After a proper consideration of the factors involved in the 42 to 50 Mc band, it was concluded that, in general, a compromise is necessary. For a receiver located in rural areas where the signal is likely to be weak and few spurious responses present, a fairly low intermediate frequency is

desirable, such as 4.3 Mc. In locations near the transmitter where the signal is strong and spurious responses are likely to be present, a relatively high intermediate response is desirable for instance, 8.26 or even 11.45 Mc. In a receiver designed for universal use the high intermediate frequency (8.26 Mc) may be the most desirable.

H. P. Thomas and R. H. Williamson of General Electric Co. described a new 50-kw frequency-modulation broadcast station which is to serve the area surrounding Schenectady and Albany. The transmitter consists of a 250-watt exciter unit feeding a 3,000-watt intermediate power amplifier which in turn feeds a 50,000-watt power amplifier. Air-cooled tubes are used in the intermediate amplifier and water-cooled tubes in the final amplifier. A newly designed 3-bay turnstile antenna is used to radiate the power of this new station. The antenna is fed by a pair of 2⁵/₈-inch concentric transmission lines.

E. S. Winlund of RCA Manufacturing Co. presented a paper entitled "Drift Analysis of the Crosby Frequency-Modulated Transmitter Circuit" in which he combined the expressions for component drift, sensitivity and bandwidth into one expression for the frequency stability of the Crosby circuit. Using experimentally determined constants he derived an equation for drift in terms of commonly used frequencies and showed the results as a family of design curves.

G. M. Brown of General Electric described the equipment used in a frequency modulation emergency system. The line consists of a receiver and two transmitters of different capacities. The smaller transmitter has an output of 25 watts and the larger one has an output of 250 watts. When the larger unit is desired, the 25-watt unit is placed in a cabinet which also contains a 250-watt power amplifier and the necessary power supplies. The power requirements of the receiver are quite flexible in that either a 115-volt 60-cps power line or a six-volt battery with a vibrator or dynamotor may be used. The application of this equipment to several emergency systems was also described.

H. F. French of the National Carbon Co. described recent improvements in B-battery portability. He

MOLDED *S. S. White* RESISTORS *The "All-Weather" Resistors*

**RANGE OF VALUES
S. S. WHITE RESISTORS**

STANDARD RANGE —

1000 ohms to 10 megohms

HIGH VALUES —

15 to 1,000,000 megohms

**SEND FOR RESISTOR
BULLETIN 37**

It contains illustrations of the different types of S. S. White Molded Resistors and gives details about construction, dimensions, etc. A copy, with Price List, mailed on request. Write for it today.

NOISE TESTED

LOW NOISE LEVEL is a feature of all S. S. White Molded Resistors. But as an accommodation to manufacturers of equipment in which noiseless operation is of first importance, S. S. White will supply resistors in the Standard Range of 1000 ohms to 10 megohms, noise tested to the following standard:

"For the complete audio frequency range, resistors shall have less noise than corresponds to a change of resistance of 1 part in 1,000,000."

Each and every resistor on such orders is tested and guaranteed to meet these specifications and can therefore be used as received without further test. This is one reason why S. S. White Resistors are so widely used in quality radio, telephone, telegraph, sound picture, television and other commercial, industrial and scientific equipment.

S. S. WHITE

The S. S. White Dental Mfg. Co.

INDUSTRIAL DIVISION

Department R, 10 East 40th St., New York, N. Y.

FOR THAT "HARD TO GET"

With Delivery on Time

TRANSFORMER

WRITE THE HEADQUARTERS FOR
AMERICA'S TRANSFORMER PROBLEMS

Suppliers to manufacturers demanding highest quality

NEW YORK TRANSFORMER CO.

Sales Department

480 LEXINGTON AVE.

NEW YORK, N. Y.

Meets F.C.C. Requirements for Frequency Checking

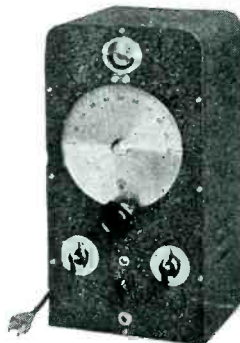

The Browning Type S-1 Frequency Meter

Custom built for your required frequencies. It furnishes precision measurement at a moderate cost.

Designed especially for police, relay, emergency and other similar transmitters.

Stable electron coupled oscillators are employed which cover very narrow bands so that reading accuracy is extremely high. These oscillators are accurately set in calibration by means of a built in 100 K.C. crystal oscillator which may in turn be checked against WWV or any standard broadcast station on a multiple of 100 K.C. No gears—no backlash error—visual indication of zero beat. Guaranteed to .01% or better. Send for descriptive circular #241.

Any 1 or 2 Bands \$97.95—3 Bands \$122.50

BROWNING LABORATORIES, INC., Winchester, Mass.

EARS

are out of date
for
Audible Inspection
of your product

Unreliable inspection often arises from the use of antiquated listening tests. No man's ear can match the scientific accuracy, the day after day consistency of modern acoustic testing instruments.

If you have an audible inspection problem, we have the specialized knowledge, experience and instruments to help you solve it—to help you save time, money and trouble!

Why not write us today?

Electrical Research Products Inc.

76 Varick Street, New York, N. Y.

A Subsidiary of

Western Electric Company



UNBRAKO

REG. U.S. PAT. OFFICE

SCREW PRODUCTS

IF you're careful about the selection of screws for electrical service, you'll compare. And having compared you'll choose "Unbrako" Products for their uniformity and strength; for their unique self-locking feature; for their knurled heads with a non-slip grip that saves assembling time. Complete range of sizes from number 4 up. Write for samples and literature.

STANDARD PRESSED STEEL CO.

Box 596, JENKINTOWN, PENNA.

WAXES • COMPOUNDS for ELECTRICAL INSULATION

Zophar offers prompt service on Insulating Compounds for a wide variety of electrical applications, including:

... insulation for CONDENSERS, TRANSFORMERS, COILS, power packs, pot heads, sockets, wiring devices, wet and dry batteries, etc. Also WAX SATURATORS for braided wire and tape. WAXES for radio parts.

Special compounds made to your order.

ZOPHAR MILLS INC.

130-26th St.

Brooklyn, N. Y.

FOUNDED 1846

described how non-essential materials and space were eliminated from the battery to such an extent that size and weight of a typical B-battery were reduced by almost 50 per cent. The new battery consists of a quantity of electrolytic mix surrounded by the electrodes and a yielding mechanical seal. The electrodes consist of a thin sheet of zinc with a coating of carbon on one side. The zinc acts as the negative electrode of one cell and the carbon acts as the positive electrode of the adjacent cell. Thus, all cells are connected in series without the use of any additional materials. The yielding mechanical seal permits the electrolytic mix to expand and contract as it will.

Magnetic Recording

S. J. Begun of the Brush Development Co. presented a discussion of "Magnetic Recording and Some of its Applications in the Broadcast Field". Recording on a ribbon made of magnetic material has certain advantages which make it a desirable recording method for broadcast stations. The same material can be used for a large number of recordings with no ill effects merely by passing the ribbon through a magnetic field to obliterate all traces of previously recorded sounds. The magnetic impression on the ribbon is not affected in any way by repeated playing. Thus, this method of recording offers economies of operation unobtainable in other methods. The speaker discussed the three essential processes of magnetic recording: obliterating the previously recorded sound, recording, and reproducing. Also discussed were the electrical and mechanical requirements of the magnetic tape and the mechanism of the recording machine. It was pointed out that it is a relatively simple matter to construct a device making use of magnetic recording to provide a short time delay in sound. Therefore, it can be applied to the production of artificial reverberation or artificial echo.

Cledo Brunetti of Lehigh University delivered a paper prepared by himself and Eric Weiss of RCA Manufacturing Co. entitled "Resistance Tuning and Its Application to the Transmitting Oscillator." The principles of tuned circuits and the application of resistance for tuning such circuits were discussed. By choosing the proper values of com-

RELAYS

★OF THE HIGHEST QUALITY
 ★TO YOUR SPECIFICATIONS
 ★AT ECONOMICAL PRICES
 ★WITH FAST SERVICE
PHONE! WIRE! WRITE!

To the Nearest Branch Office

BOSTON, MASS. Tim Coakley 11 Beacon St.	SEATTLE, WASH. Dave. M. Lee Co. 1001 Westlake Ave.
NEW YORK CITY D. R. Bittan Sales Co. 53 Park Pl.	CLEVELAND, O. Paul M. Cornell 3270 DeSota Ave.
CHICAGO, ILL. L. G. Cushing Co. 540 N. Michigan Ave.	DALLAS, TEX. Ernest L. Wilks 7935 Eustis St.
MICH., MO., AND IND. Peel Sales Engineering Co. 154 E. Erie St., Chicago, Ill.	

OUR REPRESENTATIVE WILL SHOW YOU VARIOUS TYPES OF "ADVANCE" RELAYS, DISCUSS YOUR RELAY REQUIREMENTS WITH YOU, AND SUBMIT PRICE QUOTATIONS.

Advance
ELECTRIC COMPANY
 1260 W. 2nd St. Los Angeles, Calif.



A NEW Precision Crystal
 Secondary
FREQUENCY STANDARD
 THAT HAS BEEN

"Designed for Application"

A precision frequency standard capable of being adjusted to WWV or some other primary standard and putting out uniformly accurate calibrating signals with 10, 100, 1000 KC intervals. Uses the new GENERAL ELECTRIC No. 18A 1000 KC crystal having a frequency temperature coefficient of less than one cycle /Mc/C°. The crystal is sealed in Helium in a standard metal tube envelope.

The self-contained AC power supply has VR150-30 voltage regulator tube.

In addition to oscillator, multivibrators, and harmonic amplifier, a built-in mixer with phone jack and gain control on panel is incorporated.

JAMES MILLEN MFG. CO. INC.
 150 EXCHANGE ST. MALDEN, MASS.

ponents the frequency can be made to vary linearly with the change in resistance over a considerable range. The frequency of oscillation can be made very low, under 50 cps or as high as 15 Mc by proper manipulation of the circuit elements. Resistance tuning finds use in a number of applications. For instance, it can be used as a frequency modulator, a frequency warbler and for the measurement of variations of a variety of physical quantities such as temperature, humidity, pressure, etc. A very practical application is in radio sonde transmitters where indications of atmospheric conditions must be automatically transmitted to a ground receiver.

A "Program-Operated Level-Governing Amplifier" was described by W. L. Black and N. C. Norman of the Bell Laboratories. Such an amplifier has the frequency characteristic shown in the accompanying figure. It has constant gain up to a certain point above which the gain is reduced and the amplifier acts as a compressor. This type of amplifier finds very useful application in communication systems in which the modulation for some reason must be limited to a certain value. The characteristics required for the most efficient operation of this type of amplifier were outlined and are: stable operation, sharp transition from constant gain to reduced gain as the load increases, and the time required to change gain.

C. M. Burrill of RCA Manufacturing Co. gave a statistical interpretation to the results of the Joint Co-ordination Committee on Radio Reception of the Edison Electric Institute, the National Electrical Manufacturing Association and the Radio Manufacturers Association. Sixty persons took part in the tests in an effort to determine if a meter could be designed to satisfactorily indicate the annoyance factor of noise in radio reception. Standard noises were mixed with radio programs in varying proportions and each person was asked to indicate the degree of annoyance produced by that noise according to a standard scale. An analysis of the results showed that the normal distribution curves prevailed and led to the conclusion that the performance of a noise meter designed according to the proposed standards is quite satisfactory.

K E N Y O N STANDS OUT

We are passing thru a period in our country's history when nothing must be left to chance . . . when Dependability is the keystone upon which the success of Defense rests.

For many years Kenyon Transformers have well earned a reputation for Dependability—a reputation which has been taken for granted. But in times like these the stature of the name Kenyon grows in importance for a new and more significant shade of meaning has been given to Dependability.

Our engineering department will be glad to consult with you—whether you are a manufacturer of important defense equipment or whether you are an amateur seeking really dependable transformers for your transmitter. Catalog upon request.

KENYON
TRANSFORMER CO., INC.
 840 Barry St. New York, N. Y.

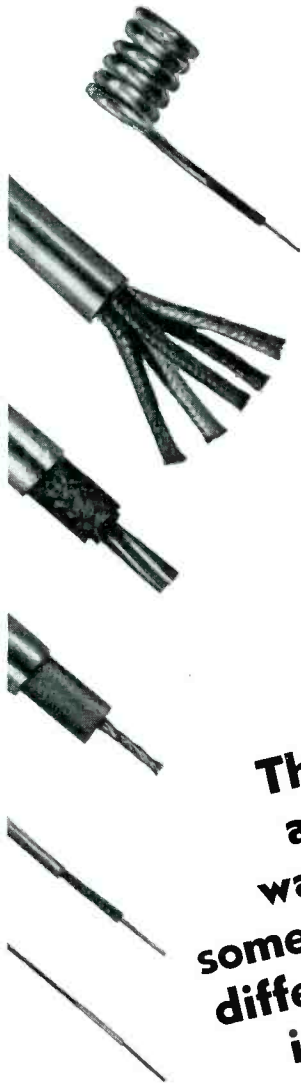

**They
all
want
something
different
in**

METAL SHIELDED WIRE

But that's all right with us Whether your Specifications call for husky multiple-cable shielding or a .019" O. D. Seamless Tube that protects a single hair-like wire, we can handle it Precision made METAL SHIELDED WIRE is formed by a special process of drawing Seamless ALUMINUM, COPPER or BRASS Tubing over any type of insulated Wire or Wires, so that any kind of a bend can be made and the ends easily trimmed. Positive protection is given to the wire against corrosion and abrasion and prevents Radio interference Has withstood the severest kind of tests Furnished in exact, multiple or random lengths.

SEND FOR FREE SAMPLES

We invite your inquiries and will gladly forward an assortment of samples for your inspection.

PRECISION TUBE CO.

Specialists in accurately drawn Seamless ALUMINUM, COPPER and BRASS Tubing, in the smaller sizes.

3826 TERRACE ST. PHILADELPHIA, PA.

Please send samples of your METAL SHIELDED WIRE to

Name

Firm

Address

Sound in Motion Pictures

(Continued from page 39)

mits the production of prints from duplicate negatives which cannot be distinguished from prints of the original negatives even by a critical audience.

It is evident that the exercise of the greatest care and use of the latest recording equipment and materials will be of little value unless the improvements achieved in recording can be reflected in the quality of reproduction obtained in the theater. Proper theater reproduction is dependent upon improving the theater reproducing equipment from time to time so that the improvement in quality obtained through the advanced recording methods will be apparent. To this end Warner Bros. has recently completely re-equipped its entire chain of theaters with the latest type of R.C.A. reproducing equipment. This change involves the installation of new type sound heads equipped with rotary stabilizers to secure uniform film motion at the point of scanning, new amplifiers of greater power handling capacity and lower distortion than those previously employed, and two-way loud speaker systems capable of reproducing, with a minimum of distortion, the entire audio spectrum recorded on the sound track.

While the majority of the theater reproducing units are of very rugged construction, highest quality reproduction can be obtained only if the reproducing equipment is frequently checked and serviced. This work is accomplished by a theater engineering service group, the members of which inspect and thoroughly test the equipment in the larger houses every week, and in the smaller houses at least once every two weeks. By this means it has been found possible to remove likely sources of trouble or partially defective equipment before a break-down occurs during a performance.

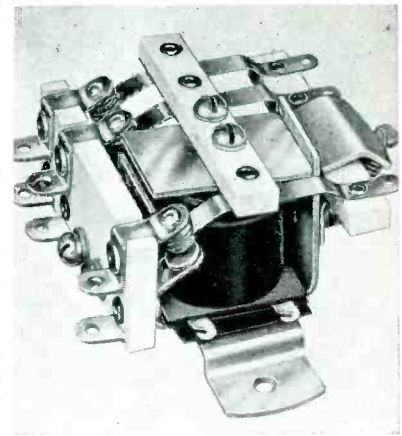

ALLIED . . . TYPE HX RELAY

A new series of four relays for modern mobile, marine and industrial equipment. They are small, rugged units of high-current capacity and low coil wattage operation.

Insulation is Alsimag. Contacts are 1/4" silver with wide spacing sufficient to handle 15 amperes at 110 volts A-C, and 7 amperes at 110 volts D-C non-inductive. Contacts available in 2-pole double-throw, and 3-pole double-throw. Coil operation can be had from 5 volts to 250 volts A-C, and from 1 volt to 125 volts D-C.

Also manufacturers of a complete line of relays for all communication and electronic uses.

Write for complete descriptive literature and prices.

ALLIED CONTROL CO., INC.
227 FULTON STREET NEW YORK CITY



SCRATCHY?

Remler Attenuators assure s-m-o-o-t-h mixing . . . completely eliminate "scratch." Silver blades on silver taps (.030" solid silver) machined to precision, "floated" on ball-bearings. Self-cleaning—soft thin silver oxide automatically wipes off with blade! Always quiet, even in low-level circuits. For complete specifications write:

REMLER COMPANY, Ltd.

19th at Bryant San Francisco

Magnetic Relays

(Continued from page 33)

7. Describe situation with regard to overrange conditions, mechanical vibration and shock, presence of corrosive fumes, gases, etc.

8. Type of case (flush or surface) and mounting position (horizontal, 45° or vertical).

9. Where a new or experimental application is involved, it is of great assistance to have a circuit diagram showing where the relay is to be used. In this connection, several organizations have developed patentable automatic-response devices using magnetic contact relays and have worked in close cooperation with the relay manufacturer on a basis of mutual confidence and good faith. It is reasonable to suppose that progress in developing such applications will continue on into new fields with ever-increasing industrial importance.

LAWRENCE RECEIVES BRITISH AWARD



Neville Butler, charge d'affaires of the British Embassy in Washington (left) is shown presenting the William DeBois Duddell memorial medal of the London Physical Society to Dr. E. O. Lawrence, professor of physics at the University of California. The medal, one of the highest awards granted by the English society, was given in recognition for Dr. Lawrence's work in the development of the cyclotron, commonly referred to as the "atom smasher"

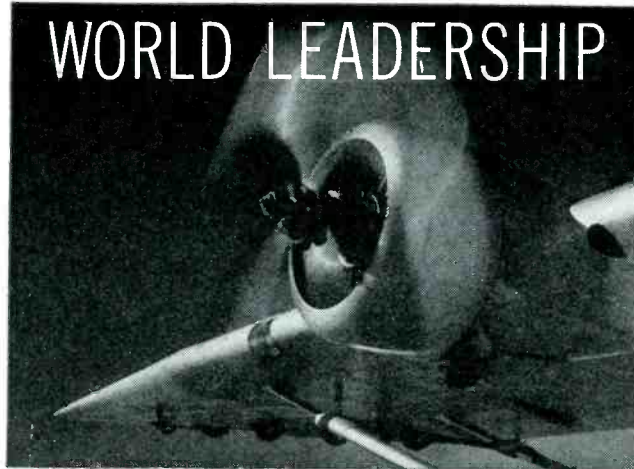

Bendix-Scintilla relies on WILCO AERALLOY!

Matchless performance! Absolute dependability! That's why you find WILCO AER-ALLOY Contact Points in Bendix-Scintilla Aircraft Magnets—the preferred magneto in every type of aircraft.

Yet in the far-famed WILCO laboratories men of vision, integrity and experience continue to pioneer—so WILCO

contact points, already peerless . . . may be *even better!*

Call on WILCO leadership for the solution of your contact or thermostatic bi-metal problem. Write for "Wilco Blue Book of Thermometals and Electrical Contacts."

The H. A. Wilson Co.
105 Chestnut St., Newark, N. J.
Br. Off.: Detroit, Mich., & Chicago, Ill.

WILCO ELECTRICAL CONTACTS

PLATINUM . . . SILVER . . . SPECIAL ALLOYS . . . TUNGSTEN



New RIDER BOOK

VTVM

OUT MARCH 1st — ORDER NOW

This new book presents the practical aspects as well as the principles underlying the various classifications of vacuum-tube voltmeters.

THE CHAPTER HEADS

1. Fundamentals of V-T Voltmeters 2. Diode VTVM 3. Triode VTVM 4. Slide-Back VTVM 5. Tuned VTVM 6. A-F and Logarithmic VTVM 7. Electronic (D-C) Voltmeters, Microammeters, Ohmmeters 8. Calibration, Testing.
9. Design, Construction. 10. Applications of VTVM.
11. Commercial Types.

150 PAGES
•
PROFUSELY ILLUSTRATED
•
HARD CLOTH COVERS
•
Only \$1.50



JOHN F. RIDER Publisher, Inc.
404 FOURTH AVENUE, NEW YORK CITY
Export Division: Rocke-International Elec. Corp., 100 Varick St., N. Y. C. Cable ARLAB



SKILL & EXPERIENCE

A compact, skilled organization . . . developed through a quarter century of manufacturing . . . personalized service for every client . . . the widest variety of fittings . . . these factors have won for CANNON Multiple-Contact Electrical Cable Connectors recognized leadership in a world market. CANNON Plugs are pre-eminent in the fields of Sound, Aeronautics, Geophysical Research, Instrument-Control on Ships and Laboratory Panels.

Illustrated Bulletins afford valuable information on Plug Problems. Bulletin "P & O" devoted exclusively to Sound. Please specify your requirements when requesting Bulletins.

CANNON ELECTRIC DEVELOPMENT CO.
3209 HUMBOLDT ST., LOS ANGELES, CALIFORNIA
Eastern Sales Office: 220 Fifth Ave., New York, N. Y.
Chicago: Kelburn Engineering Co., 600 W. Jackson Blvd.



CANNON PLUGS

THE INDUSTRY IN REVIEW

News

◆ Stupakoff Laboratories, Inc., announces that it has changed its name to Stupakoff Ceramic & Mfg. Co. On January 1, 1941, the company moved to its new and larger quarters located at Latrobe, Pa. Stupakoff specialized in insulation for electron tubes, communications, high temperature pyrometers, etc. . . . Several promotions in the executive personnel of RCA Manufacturing Co., Inc., were announced recently. One promotion is that of E. W. Ritter, former general manager of radio tube manufacturing, elected vice-president in charge of all the company's manufacturing and production engineering activities. Another promotion is that of E. W. Engstrom, former director of general research, who will now be manager of all research activities for the company.

◆ Howard Gates has been named President and Director of the Majestic Radio and Television Corp. of Chicago . . . Ward Leonard Elec. Co. announces the opening of a branch office at 183 Main Street East, Rochester, N. Y. It will be under the management of J. K. Savage, Sales Engineer . . . C. L. Walker, radio engineer formerly with United American Bosch Corp., has been appointed Assistant Chief Engineer of Utah Radio Products.

◆ The United States Civil Service Commission has announced examinations to fill the positions of radio inspector in the Federal Communications Commission at \$2,600 a year, and assistant radio inspector in various departments at \$2,000 a year. The salaries are subject to a 3½ per cent retirement deduction. Applications must be filed at the Civil Service Commission's Washington office not later than March 6 and March 10, 1941, the extra time being allowed for those sent from Colorado and states westward . . . The duties of these positions involve code ability and inspection of radio equipment on ships, aircraft, and at various land stations. . . . Universal Microphone Co., Inglewood, Cal., has been awarded a contract under the defense program by the U. S. Army Signal Corps for a large quantity of carbon type microphones to be used for various communications activities. The west coast factory is being reorganized to maintain a constant production of 300 microphones a day on the special government contract. Procurement officials for the Navy Department have also asked for reservation on fifty percent of the Universal output facilities within a short time.

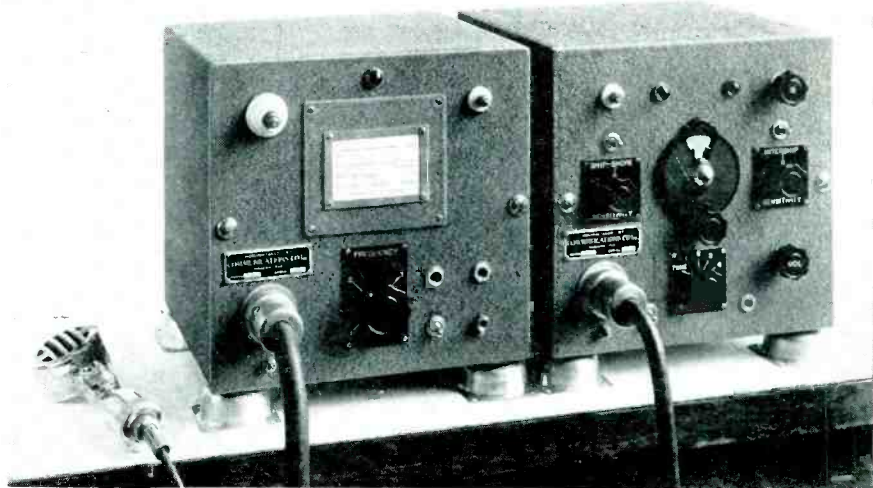

Communications Company, Inc., marine radio telephone equipment

◆ John L. Callahan, Engineer, RCA Communications, Inc., has been elected President of The Radio Club of America for 1941. Other officers for the current year are as follows: Paul Ware, Engineer, DuMont Laboratories, Vice President; Lincoln Walsh, Consulting Engineer, Corresponding Secretary; H. M. Lewis, Engineer, Hazeltine Service Corp., Recording Secretary; Joseph J. Stantley, General Manager, Continental Sales Co., Treasurer. The Radio Club of America, a national organization, with headquarters at 11 West 42nd Street, New York City, has played an important role in the development of radio. Founded in 1909, it has among its members most of the leading scientists and engineers in the country who have brought before the Club the results of their work. Professor L. A. Hazeltine's announcement of the neutrodyne was first made public before the Club, as well as many of the recent developments of Professor E. H. Armstrong, such as his latest development of wide-band frequency modulation. The Club meets monthly at Columbia University to hear the current developments in radio and its allied subjects.

◆ Henry W. Roberts, for many years the Radio Editor of *Aero Digest* magazine, recently joined the staff of Lear Avia, Inc., as Director of Public Relations. He is now in charge of Learadio press and advertising matters. . . . Guy C. Hickok, formerly director of short-wave broadcasting of the National

Broadcasting Company, has joined the Council of National Defense for the Coordination of Commercial and Cultural Relations Between the American Republics. One of the major duties of the radio committee will be the coordination of American short-wave service to Latin America and the promotion of American programs throughout South America. . . . A center for one of the largest airline teletype systems in the world has been established in Dayton, O., by Transcontinental and Western Air, Inc., to speed the transmission of nearly 3,000,000 words a month, according to Howard K. Morgan, superintendent of communications for TWA. More than 2,100 miles of specially leased wire is connected to the expanded teletype system to handle inter-department operations and reservations messages. . . . With the completion of an addition to their No. 2 plant, Harvey Radio Laboratories have now consolidated all manufacturing operations at 447 Concord Ave., Cambridge, Mass. . . . Electronic Control Corp. has moved to 626 Harper Ave., Detroit, Mich. The new plant has facilities for manufacturing electronic as well as electro-mechanical devices. New officers are Mackworth G. Rees, President; Ralph A. Powers, Vice President; and Frank Hillebrand, Secretary. . . . Norman B. Neely, West Coast manufacturers' agent, recently opened an office at 420 Market St., San Francisco, Cal. Homer E. Beren, sales engineer, will be in charge of these new quarters. . . . The Callite Tungsten Corp., Union City, N. J., announces the appointment of Harold M. Malm as factory sales engineer. . . . The ap-

Dependable ONAN ELECTRIC PLANTS

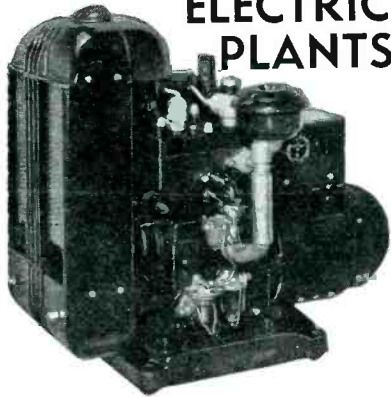

COMPLETE — READY TO OPERATE ON THE JOB during Emergencies when Power Lines fail.

Operate anything Electrical — LIGHTS, RADIC TRANSMITTERS and RECEIVERS, Motors, X-Ray, All Appliances. Used by City, State and Federal Departments, Police and Fire Departments, in News Pickup and Advertising Cars, Public Buildings.

NEW STYLES — MANY NEW MODELS — OVER 40 STOCK MODELS 350 to 50,000 Watts. Any Voltage — any Frequency — Completely Radio Shielded. Highest Quality — Compact — Heavy Duty.

WRITE for Complete Details

D. W. ONAN & SONS

329 Royalston Ave. Minneapolis, Minn.

How Much Can EXPERIENCE SAVE YOU?

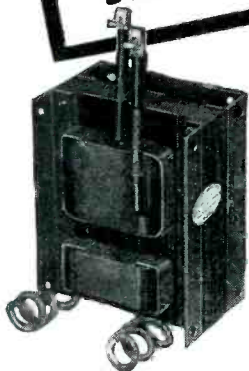

Acme also manufactures: Fluorescent Lamp Ballasts; Luminous Tube transformers; Radio and Television transformers; Mercury Vapor transformers; Air-Cooled distribution transformers; Signalling transformers and Transformer-type testing devices.

One mistake prevented may save thousands of dollars. And that is particularly true in designing transformers for your equipment, for good transformer design requires special experience.

Consult Acme and gain the multiplied experience of an organization, specializing in the exclusive manufacturing of transformers.

THE ACME ELECTRIC & MFG. CO.
31 WATER STREET • CUBA, NEW YORK

Acme Electric
TRANSFORMERS

pointment of T. A. Abbott as Manager Sales, Meter Division, has been announced by the General Electric Meter Division. . . Delta-Star Electric Company, Chicago, and Canadian Line Materials, Ltd., Scarborough Junction, Canada, announce the association of their respective companies for the exclusive manufacture of Delta-Star equipment in Canada. . . Standard Electrical Products Co., formerly of St. Paul, has moved to new and larger quarters at 417 1st Ave., N., Minneapolis, Minn. . . The Department of Commerce, Washington, D. C., reports that exports of radio equipment during November totaled \$2,136,538 as compared with \$1,891,812 for the month previous, with all classifications in this group indicating increases. Receiving sets sold in world markets in November were valued at \$1,072,615, a decline of only \$1,310 compared with the March exports, which were the highest of the year. Foreign markets for telephone equipment, including telephone instruments and parts during November were 7.9% less than October, decreasing from \$425,462 to \$391,736. Exports of motors, one-third hp and under, were valued at \$258,574, the peak month of the year for this item, and an increase of 220% over the October total of \$80,578.

♦ Eicor, manufacturers of dynamotors, small aircraft d-c motors, power plants, and converters, are now located in a larger plant at 1060 W. Adams St., Chicago. . . A \$300,000 private limited company has been organized in India to manufacture radio receiving sets and parts. The company, known as the National Radio and Engineering Co., Ltd., is the first enterprise of its kind in India, the U. S. Department of Commerce reports. Major portion of the company's capital is owned by the Investment Corp. of India, subsidiary of Tata Sons. It is estimated that the factory will eventually produce 10,000 receiving sets annually, with production scheduled to start by the middle of this year. No definite plans have been formulated as to the types of equipment to be manufactured. It is reported that the company will need some American machinery. . . For the purpose of studying all phases of amateur radio facilities, James L. Fly, Chairman of the Defense Communications Board, and the American Radio Relay League have appointed a representative and six regional advisors to the Amateur Radio Committee of the Board. The committee is to consider all questions relating to amateur radio and its place in the national defense structure. . . A radio engineering conference was held on January 14th for the purpose of harmonizing the action of the radio administrations of Canada, Cuba, Dominican Republic, Haiti, Mexico and the United States, so that the assignment of frequencies to broadcasting stations in the standard

SENSITIVE ELECTRONIC AC VOLTMETER MODEL 300



- New operating principle.
- 10-100,000 cycles.
- 1 millivolt to 100 volts in five ranges (to 1,000 and 10,000 volts with multiplier).
- Logarithmic voltage scale and uniform decibel scale.
- A-C operation, 115 or 230 volts, 50-60 cycles (rack mounting and battery-operated models also available).
- Permanent calibration, unaffected by variation in line voltage, tubes, etc. Accuracy 2%.
- Can also be used as an amplifier (70 DB gain) flat to 100,000 cycles.

MODEL 402 MULTIPLIER



Newest addition to a line of accessories designed to increase the utility of the Model 300 Voltmeter. This multiplier has two important uses: (1) to provide additional ranges of 1,000 and 10,000 volts full scale, and (2) to increase the input impedance so that, when full sensitivity is not required, measurements may be made on very high impedance circuits. The input impedance on the 1,000-volt range is 4.4 megohms and on the 10,000-volt range 44 megohms.

Send for Bulletin 2E.

Ballantine Laboratories, Inc.

BOONTON

NEW JERSEY

Full Size **Accurate**
Easy Reading
PRECISION
INDUSTRIAL TESTERS
Portable **Rugged**

The two highly popular instruments, described below are representative of the more than 40 instrument models in the "PRECISION" 1941 line; providing a versatile selection to satisfy almost every production testing and laboratory requirement.

Write for the new PRECISION 1941 catalog.



Series 844—34 Range—AC-DC
Volt - Ohm - Decibel - Milliammeter - Ammeter
6000 Volts AC-DC, 10 Megohms,
12 Amperes

An all-purpose multi-range tester, the Series 844 is but a single example of an instrument that has literally SOLD ITSELF—PRECISION engineered to highest standards of accuracy, workmanship and quality, the Series 844, as all equipment bearing the name "PRECISION", has been designed to provide lasting satisfaction under constant usage.

- ★ AC and DC voltage ranges at standard 1000 ohms per volt sensitivity 0-12-60-300-600-1200-6000 volts
- ★ Current ranges—0-1.2-12-60-300-1200 mils, 0-12 AMPS.
- ★ Resistance ranges—0-400, 0-100M 0-1 meg 0-10 megs—(self-contained)
- ★ Decibel ranges from -12 to +70DB
- ★ Easy reading 4- $\frac{1}{2}$ " bakelite cased 400 microampere meter

Series 844L—illustrated and described—in walnut finished hardwood laboratory case with leather handle (7 $\frac{1}{2}$ "x8 $\frac{1}{2}$ "x4") less batteries and test leads **\$22.95**
 Net Price

Series 920

Combination
 Dynamic
 Mutual
 Conductance
 Type Tube
 Tester and
33 RANGE
 Rotary Selective
 AC-DC
 Multi-Range
 Set Tester



The Series 920 provides a complete, compact, portable measurements laboratory, combining the time-proven PRECISION Dynamic Mutual Conductance Type Tube Testing circuit as well as almost every one of the AC-DC functions described for the Series 844 above.

Series 920P—(illustrated) complete with internal ohmmeter battery and test leads **\$53.95**
 Net Price

PRECISION TEST EQUIPMENT
 Standard of Accuracy SEE THEM AT YOUR JOBBER

PRECISION APPARATUS COMPANY
 647 Kent Avenue Brooklyn, N. Y.
 Export Div.: 458 Broadway, New York, U. S. A.
 Cables: Morhanex

broadcasting band will be in conformity with the provisions of the North American Regional Broadcasting Agreement signed at Habana on December 13, 1937. The provisions of this convention will become effective March 29, 1941.

Literature

Instruments and Time Switches. General Electric Co., Schenectady, N. Y., have published Bulletin GEA-2753 which describes briefly such instruments as a hook-on volt-ammeter for a-c operation; portable test instruments for ac or dc; inkless recording instruments; strip-chart recording instruments; round-chart recording instruments; and type KT time meters.

Pick-up Information. "Pick-up Facts" is the title of a bulletin available from Audak Co., 500 Fifth Ave., New York City, which contains reprints from ELECTRONICS, Communications, Broadcast Engineering, Radio Service, etc. These reprinted quotations are intended to answer the everyday questions on pick-up problems.

Photoelectric Cell Catalog. A new catalog, No. 101, available from Bradley Laboratories, 82 Meadow St., New Haven, Conn., contains electrical characteristics, illustrations and descriptive material on a complete line of "Luxtron" photo-electric cells. Listed types include both mounted and unmounted cells, round or rectangular, in a variety of sizes and in several different terminal arrangements.

Remote Control. Radio Control Headquarters, Inc., Granby, Conn., have published a booklet "The Radio Control Instruction Manual" which contains data on circuits, systems and apparatus for radio control of models. This booklet is available for ten cents from the publisher.

Pyrometer Catalog. All the latest improvements made in the Celestray line of pyrometers during the past year are included in catalog No. 1101F recently published by C. J. Tagliabue Mfg. Co., Park and Nostrand Aves., Brooklyn, N. Y.

Recording Blanks. The Recordisc Corp., 395 Broadway, New York City, have available a pamphlet *Snapshots in Sound* which describes three grades (semi-professional, economical and amateur lines) in both nitrate and non-inflammable coatings. Playback needles and cutting needles are also described.

Portable Instruments. Bulletin P-10-1 contains information on portable instruments fused for safety and long life. Several types are included in this nine page bulletin available from The Winslow Co., Inc., 9 Liberty St., Newark, N. J.

Note

The Library comprises a selection of books culled from leading McGraw-Hill publications in the radio field.

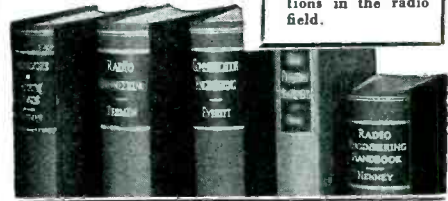

McGraw-Hill
RADIO
ENGINEERING
LIBRARY

—especially selected by radio specialists of McGraw-Hill publications

—to give most complete, dependable coverage of facts needed by all whose fields are grounded on radio fundamentals.

—available at a special price and terms

These books cover circuit phenomena, tube theory, networks, measurements, and other subjects—give specialized treatment of all fields of practical design and application. They are books of recognized position in the literature—books you will refer to and be referred to often. If you are a researcher or experimenter—if your interest in radio is deep-set and based on a real desire to go further in this field—you want these books for the help they give in hundreds of problems throughout the whole field of radio engineering.

5 volumes 3319 pages, 2298 illustrations

1. Eastman's FUNDAMENTALS OF VACUUM TUBES
2. Terman's RADIO ENGINEERING
3. Everitt's COMMUNICATION ENGINEERING
4. Hund's HIGH-FREQUENCY MEASUREMENTS
5. Henney's RADIO ENGINEERING HANDBOOK

Special Low Price and Easy Terms

Bought singly, the five volumes comprising this library would cost you more. Under this offer you save money and, in addition, have the privilege of paying in easy installments beginning with \$2.50, 10 days after receipt of the books, and \$3.00 monthly thereafter. Already these books are recognized as standard works that you are bound to require sooner or later. Take advantage of these convenient terms to add them to your library now.

SEND THIS ON APPROVAL COUPON

McGraw-Hill Book Co., Inc.
 330 W. 42nd St., New York, N. Y.

Send me the McGraw-Hill Radio Engineering Library 5 vols., for 10 days' examination on approval. In 10 days I will send \$2.50, plus few cents postage, and \$3.00 monthly till \$23.50 is paid, or return books postpaid. (We pay postage on orders accompanied by remittance of first installment.)

Name

Address

City and State

Position

Company L. 2-41

(Books sent on approval in U. S. and Canada only.)

Universal Capacitors. A new catalog with complete details and replacement recommendations for a-c motor starting service is available from P. R. Malloy & Co., Inc., Indianapolis, Ind. The catalog contains ten pages of alphabetical listings of motor manufacturers.

Photoelectric Relays. A seven page illustrated booklet (Price List No. 18-312) available from Westinghouse Elec. & Mfg. Co., Dept. 7-N-20, East Pittsburgh, Pa., describes type RQ Photo-troller and its accessories. RQ type Photo-trollers are general purpose photoelectric relays for operation on 115 volt indoor service.

Rheostats. Rotary drive rheostats for switchboard mounting and motor operated rheostats for remote control are described and illustrated in bulletin S available from Rex Rheostat Co., 37 West 20th St., New York City. Other types of rheostats also described include four-range, table rotary drive and vertically mounted table rheostats.

Testing Capacitors. "Methods of Testing Capacitors," an article by the Engineering Dept. of Aerovox Corp., New Bedford, Mass., is the subject discussed in an issue of *The Aerovox Research Worker*. Another issue contains an article on the subject of "Aids in Filter Design."

Centralab Catalogs. Centralab, 900 E. Keefe Ave., Milwaukee, Wis., have available two catalogs. The first, No. 22, is a general catalog which contains information on controls, resistors, selector switches and ceramic capacitors. The second catalog form 630-5M is an engineering data sheet on ceramic capacitors, containing dimensions, specifications, data on temperature compensation, etc.

The Measurement of Surface Finishes. This subject is treated in the September issue of *Brush Strokes*, a house organ published from time to time by The Brush Development Co., 3322 Perkins Ave., Cleveland, Ohio. Several charts of different surfaces are used to illustrate the article.

Parts Catalog. A complete showing of RCA test equipment is presented in the 1941 edition of the RCA Radio and Television Test Equipment Catalog No. 105. Several new radio and television test equipments, and phonograph modernization assemblies, are included.

Radio Components Catalog. General Catalog No. 41 includes information on wires and cables, hardware, antennas and ceramics available from Birnbach Radio Co. Inc., 145 Hudson St., New York City.

Tubing. A catalog entitled "Taking Specials in Stride" tells about the special purpose tubing which is produced to specification by Summerill Tubing Co., Bridgeport, Montgomery County, Pa.



PERMANENT MAGNETS

ALL SHAPES — ALL SIZES
FOR ALL PURPOSES

Stamped, Formed, and Cast; Chrome, Tungsten Cobalt and **ALNICO**** (cast or sintered) under G. E. license.

THOMAS & SKINNER

STEEL PRODUCTS COMPANY
1116 E. 23rd STREET INDIANAPOLIS, INDIANA

**Laminations for Radio Transformers — Tools
Dies — Heat Treating — Stampings**

39 YEARS EXPERIENCE



As business paper publishers for over fifty years, McGraw-Hill is uniquely equipped to offer complete, authoritative direct mail coverage of industry's major markets. Extreme accuracy is maintained (guaranteed to 98%) and through careful analysis of markets, complete classification of companies and personnel, etc., the widest possible selections are available. Send for handy reference folder, "Hundreds of Thousands of Reasons Why" which describes how McGraw-Hill Lists are built and maintained.

What Fields Do You Want to Reach?

- Aviation
- Bus & Electric Railways
- Civil Engineering and Construction
- Administrative Executives
- Electrical Dealers & Wholesalers
- Mill Supply Houses
- Power Services
- Product Engineering & Design
- Production and Maintenance
- Radio Dealers & Wholesalers
- Radio Engineering & Design

For further details, selections from above basic classifications, counts, prices, etc., or estimates on special lists . . . ask any representative or write to



Complete Lists Covering Industry's Major Markets

SEND NOW FOR THIS HANDY, NEW,

OHMITE Ohm's Law Calculator



Solves any Ohm's Law Problem with one setting of the slide

Everyone's excited about this remarkable Calculator! All values are direct reading. Scales on both sides cover the low current high resistance Radio, Sound and Electronic applications; also the current and wattage range for motors, generators, lamps, electrical apparatus and other applications up to 100 amperes or 1000 watts. Convenient Stock Unit Selector tells the stock numbers of the resistor or rheostat you may need. Size 4 1/8" x 9". Specially designed by Ohmite Engineers.

Send coupon or write on company letterhead giving name and position. Enclose 10¢ to cover cost of handling.

OHMITE MANUFACTURING CO.
4817 Flournoy St., Chicago, U.S.A.
10¢ in coin enclosed. Send Ohm's Law Calculator. (Please Print Clearly)

Name

Firm Name

Position

Address

City

State

Electronics-Feb.

Be Right with OHMITE
RHEOSTATS · RESISTORS · TAP SWITCHES

"A picture
is worth
10,000 words"

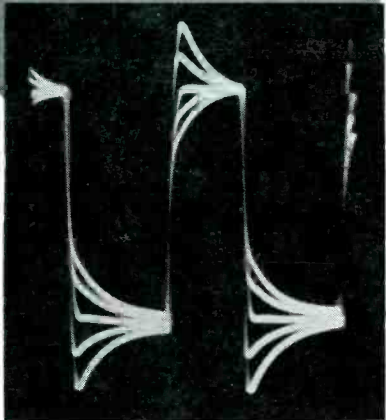

★ One problem encountered in the design of the DuMont Type 208 Cathode-Ray Oscillograph was the provision of a cathode-loaded input stage which would operate with input potentials as high as 250 r.m.s. volts. This requirement was solved by incorporating in the instrument a resistance-capacity compensated attenuator which was to be accurately adjusted in production to correct for minor variations in stray-circuit capacitances.



★ The production solution of this problem is shown in the above oscillogram taken during production test of a Type 208 instrument. This unretouched oscillogram is a composite of five exposures taken at different adjustments of the input attenuator with a square-wave test signal applied. It shows the process of balancing the capacity section of the attenuator to match the resistance section, and it illustrates how square-wave distortion is eliminated by proper balance of the attenuator.



★ We show this process here because we feel that the use of such a test procedure illustrates, better than any story, the unusual attention to detail which takes place in the manufacture of this cathode-ray oscillograph. The square-wave balancing of the input attenuator, and the square-wave adjustment of the amplifier peaking coils, are but two of 35 major test procedures to which the Type 208 instrument is subjected before it leaves the DuMont plant. We feel that such care in the manufacture of an instrument upon which your own work depends, is part of your assurance that DuMont instruments are properly designed and manufactured to do the work for which they are intended.

Literature sent on request



**ALLEN B. DU MONT
LABORATORIES, Inc.**

Passaic ★ New Jersey

Cable Address: Wespexlin, New York

Resistor Catalog. A new Koolohm wire-wound resistor catalog specifically designed for industrial users and illustrating design opportunities made possible by this resistor type is now available from Sprague Products Co., North Adams, Mass.

Superheterodyne Converters. "Notes on Superhet Converters" is the title of an article published in an issue of *Successful Servicing*, Vol. 7, No. 1, published by John F. Rider, 404 Fourth Ave., New York City.

Synchro-Sound Recorder. For twenty-five cents a booklet entitled "How to Make Talking Pictures at Home" may be purchased from Presto Recording Corp., 242 West 55th St., New York City. This booklet gives a complete description of the Presto synchro-sound recorder and its operation.

Rotary Instrument Switches. Shallcross Mfg. Co., Collingdale, Pa., have published Bulletin No. 500-M which describes their switches for the electrical, industrial, radio and instrument fields.

G-R Publications. Vol. XV, No. 4, of the *G-R Experimenter* contains the following articles: "An Improved Measuring Circuit for the Susceptance Variation Method," "Notes on the Care and Maintenance of G-R Instruments" and "Variacs in Combination." Another bulletin "Insulation Testing at Low Voltage" is also available.

Speakers. Cinaudagraph Speakers, Inc., 2 Selleck St., Stamford, Conn., have available their 1941 catalog which describes and illustrates speakers manufactured by that company.

F-M Broadcast Transmitter Type GF-103-B (3000 watt) F-M broadcast transmitter is described and illustrated in bulletin GEA-3485 available from General Electric Co, Schenectady, N. Y.

Radio and Electrical Test Equipment. Catalog No. 124 is a sixteen page bulletin available from Radio City Products Co., 88 Park Place, New York City. This 1941 catalog covers the complete line of radio and electrical test equipment (over forty-five models) available from R.C.P.

Capacitors. Cornell-Dubilier Electric Corp., South Plainfield, N. J., have published their 1941 abridged catalog No. 185A which contains concise and complete information on capacitors.

Radio Control. This fourteen page booklet is entitled "Radio Control," a collection of circuits and ideas, some old, some new, which give an idea of what can be done with the equipment now available for control of boats, trains, etc. It was written by G. Toben, of the Nathan R. Smith Mfg. Co., 105 Pasadena Ave., South Pasadena, Cal. This is the third edition and the cost of the booklet is fifty cents.

New Products

Disc Recorder

A NEW TYPE DISC RECORDER which is designated as type 73-A is available from RCA Mfg. Co., Camden, N. J. It is a precision device built to provide instantaneous recordings for broadcast purposes. The instrument records at 33½ or 78 rpm, and from either the outside in or the inside out without changing leadscrews or gears. It will cut 96, 112, 120, 136 or 154 grooves per inch. The recording head has a frequency response of from 30 to 10,000 cps and operates with high amplitude and low distortion. A newly developed stabilizer prevents modulation resulting from "flutter" in the cutting head. The speed and groove adjustments are

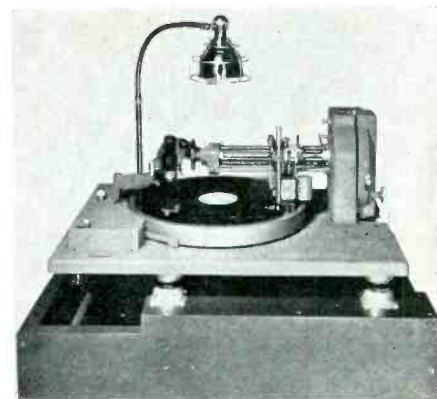

made by turning a knob. An improved cutter head lowering mechanism is operated by one hand, and is designed to protect against damaging stylus or record. Thumbscrews provide accurate adjustments for stylus angle and depth of cut. The turntable is rim-driven by two large motors operating simultaneously. A microscope is provided for observing the grooves as they are cut and a small shielded lamp is mounted on the adjustable microscope supporting arm to provide illumination directly under the microscope's lens. General illumination for the unit is provided by a lamp supported on a long flexible "goose neck." An adjustable suction nozzle draws shavings away from the cutting head. A suction pump and coupling hose are available on separate order. The recorder measures 30 inches wide, 20½ inches deep and 25 inches high.

Electronic General Purpose Timer

A NEW, LOW COST, GENERAL PURPOSE TIMER, (model 52) capable of providing accurate automatic timing control for almost any requirement where cycling or sequencing must be controlled in seconds or fractions of seconds, is announced by Weltronic Corporation, 3091 East Outer Drive, Detroit, Michi-



OXFORD
Speakers



when they ask you to sharpen your pencil

to a needle point . . . you can meet all competition by specifying

Oxford Tartak Speakers

Yet in spite of low costs they will give a superlative performance: just as they are doing in millions of receivers.

OXFORD-TARTAK
RADIO CORPORATION
915 W. VAN BUREN ST. • CHICAGO, U. S. A.

Automatic

TIME DELAY

For Use *Control*

... where Precision-Timed "Warm-Up", storage, or other inactive period is required after switch is thrown. Now used in Magneto production, Welding, Radio Transmitters, etc.

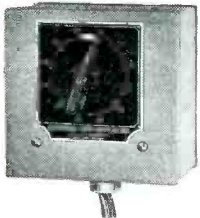

SERIES TD-60 in durable metal case 5"x5"x2 3/4". Contact rating 1500 watts non-inductive

- ★ Synchronous Motor Driven
- ★ Fully Automatic, instantaneous Automatic Reset
- ★ Fully Adjustable from 1 sec. to 55 minutes SPLIT-SECOND ACCURACY
- ★ Units furnished for flush or panel mounting

Write Today for Latest Bulletin

Industrial Timer
CORPORATION

103 Edison Place • Newark, N.J.

gan. Feature of this timer is the rapidity of adjustment afforded by the selector knob by which the operator may set the timer by merely dialing for the correct time. Timing limits range from 1/30th second to 120 seconds. The timer is available for 110 or 220 volts and for any commercial frequency. In order to provide for fool-proof control, the timer is available with a maintaining circuit which permits the timer to be initiated by momentary touch of the pilot device. Otherwise the pilot device must be held closed until the timing has terminated.

Magnetic Pickup

AVAILABLE FROM THE TURNER CO., Cedar Rapids, Iowa is model MM magnetic pickup intended for musical instruments. It has a continuously variable built-in volume control. The instrument has a high impedance which works directly to a tube grid. The unit is 3 1/4 inches long x 1 1/8 inches wide and is supplied with a twenty-five foot cable. It can be used for solos or for whole groups of instruments.

Vacuum Tube Voltmeter

MODEL 62, STABILIZED a-c, d-c vacuum tube voltmeter is a new instrument available from Measurements Corp., Boonton, N. J. It has a push-button selection of five ranges: 1, 3, 10, 30, and 100 volts full scale. The accuracy on each range is 2 per cent of the full scale, and the power supply (no batteries) is 115 volts, 60 cps.



As a d-c voltmeter it has stabilized, balanced, degenerative amplifiers which eliminate "zero drift." Other characteristics are a very high input resistance; less than 10⁻³ amp grid current on all ranges; provision for reversal of polarity, and linear scale calibration on all d-c ranges.

As an a-c voltmeter it has a balanced diode circuit which eliminates annoying zero drift on a-c ranges; a compact, low-loss, low capacity probe designed for minimum loading at high frequencies; a blocking condenser to separate a-c from d-c potentials applied to probe. On a-c the instrument is a peak voltmeter calibrated to read rms values of a sine wave or 71 per cent of the peak value of a complex wave.

**New! Rapid!
Accurate!**

SHALLCROSS

per cent
**LIMIT
BRIDGE**



Easy to operate, requires no technical knowledge.

Tests and compares the resistance of coils, resistors from a fraction of an ohm to 10 megohms or more.

Built-in adjustable Resistance Standard. Built-in suspension galvanometer.

± 2—5—10—15—20%
or any other combination

Write for Bulletin No. 146-KM

SHALLCROSS MFG. CO.
Instruments — Resistors — Switches
COLLINGDALE, PA.



for
SENSITIVITY

D.C. RELAYS

operating at one to fifty milliwatts to control A.C. loads of 50 to 1000 watts

A.F. RELAYS

actuated by telephonically applied sound to initiate control functions through other relays

ACOUSTIC SWITCHES

with sensitivity adjustable for desired response to sounds of high or low intensity.

Write for Data Sheet Number Seven listing new Sigma products including the type 3-U one milliwatt relay.

Sigma Instruments, Inc.
76-78 Freeport Street
Boston Massachusetts

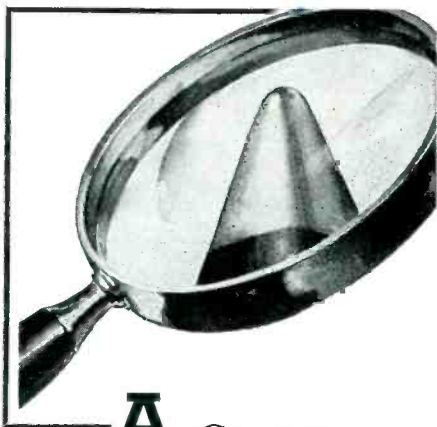

A Greater Metallurgy Service

A greatly enlarged Metallurgy Division makes Permo Metal available to industry on an increased scale.

Permo Metal is a smooth, wear resisting, non-corrosive alloy with a low coefficient of friction, made of precious metals (Osmium, Ruthenium, etc.).

Instrument bearings, long life fountain pen tips, phonograph needles and contacts . . . are just a few of countless uses of these remarkable alloys.

An additional service of preliminary assembly of material to holder or shank is also available. Write for detailed data.

PERMO PRODUCTS CORP.
Manufacturing Metallurgists
6427 RAVENSWOOD AVE. CHICAGO, ILLINOIS

100-Watt Transmitter-Receiver

FLEXIBILITY OF OPERATION, and the use of extreme safety factors feature this newest 100-watt radio telephone of Harvey Radio Laboratories, Inc. All cabinet elements are protected against corrosion. The various components and the way they are mounted enable the equipment to withstand 100 per cent humidity. Failure due to overheating

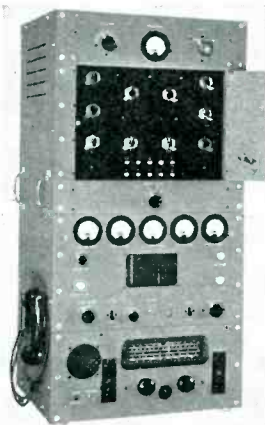

is eliminated. Tubes are operated at less than half their rated capacities. Ten pretuned channels are made available through a single front-panel switch. The equipment measuring 21x28x60 inches is designed to be semi-portable, and to maintain satisfactory communication under cover, or exposed, on shore or afloat, permanently installed or in transport.

Communication Receiver

HOWARD RADIO Co., 1731 BELMONT, Chicago, announces a new line of communication receivers. These receivers tune in from 550 Kc to 43 Mc. All models have a stage of trf on all bands. Illustrated is Model 453-A, which has seven tubes (including rectifier) and a built-in Howard-Jensen speaker. The seven tube model



is designed so that it can be returned to the factory at any time and changed into an eight or nine tube model. Accessories, including a two stage pre-amplifier, monitor and carrier level meter, are available and can be added at any time. This Howard Progressive Series permits the amateur to start with the seven tube model and then build in easy stages until he has a complete fifteen tube receiver.

HARVEY products are designed to deliver *satisfactory communication* under extreme operating conditions.

HARVEY will ask you to pay a little more, for the extra security, the extra long life, the extra usability you receive from its products.

HARVEY equipment in standard models serves users at sea, on land, in the air, on every continent (including Antarctica). A conservative policy of applying ALL necessary safety factors to equipment designed to meet special conditions consistently satisfies Navy and Army buyers in the United States and abroad.

State intended use, desired power, and describe operating conditions when requesting information.

HARVEY Radio Laboratories, Inc.
447 Concord Avenue Cambridge, Mass.



A Better POWER RHEOSTAT



Resistance winding on insulated heat-dissipating core.

Heat-resistant ceramic body. Cold-setting inorganic cement. Ceramic rotor insulator.

Unique tripod-type rotor. Graphite-copper contact shoe rides collector ring and winding.

25-watt rating even at 1/2 resistance setting. A brute for punishment.

★ We honestly believe we have the finest power rheostat yet introduced. But of course we are biased. So it's more convincing to tell you that the Army is ordering large quantities of these Clarostat Power Rheostats for aircraft use. Likewise other critical users. These rheostats have passed the most rigid specs. and tests with flying colors.

★ Write for engineering data on this latest Clarostat achievement. Specs., quotations, samples, to responsible parties.

CLAROSTAT
MANUFACTURING CO.
Incorporated
285 North Sixth St.
Brooklyn, N. Y.

Two-Way Portable Radio

LEAR AVIA, INC., (DAYTON, OHIO), announces the development of a new two-way portable radio. Originally designed for military use, this radio has been adapted and released for commercial and export uses. Compact and rugged, the unit operates in the 3000-6000 kc band, and provides a definite means of communication between a ground station and aircraft in flight. The only installation provisions necessary are an antenna and a 12-volt dc supply. Designated as Model TRM-204, the two-way unit is comprised of a 10-watt transmitter and a companion

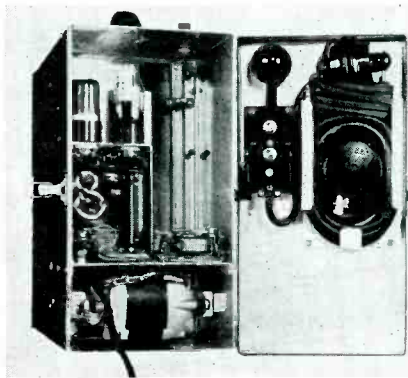

receiver, both housed in a single carrying case. The power supply unit for both the transmitter and the receiver is a special type dynamotor which is housed in the bottom of the carrying

case, measuring 12x6½x12½ inches. The weight of the entire unit, excluding accessories and the storage battery, is 20 lbs 5 oz. The transmitter, master oscillator type, has an output of 10 watts in the 3000-6000 kc bands into an optimum antenna. Any frequency within the transmitter's range may be crystal controlled since the transmitter is provided with an externally attachable crystal.

This unit is designed for use in aircraft or for mobile use on land and sea.

Mobile Amplifier

AN 18-WATT AMPLIFIER for mobile and portable applications is available from Thordarson Electric Mfg. Co., 500 W. Huron St., Chicago. It operates from 6 volts dc or 115 volts ac. The power output is sufficient for sound trucks, picnics, carnivals, and other similar installations. All input, output and power connections are made on the front panel of the amplifier to eliminate cable interference when the unit is placed in the front seat of a car or sound truck. Amplifier controls are mounted at a convenient operating angle and are slightly recessed. The amplifier includes an electric phono motor and pickup. Separate microphone and phono volume controls permit mixing of record and voice. The tone control may be used for reducing scratch and for correcting acoustical conditions. Catalog No. 600-E contains further information about these amplifiers.

Voltage Regulator

UNITED TRANSFORMER CORP., 150 VARI-CK ST., NEW YORK CITY, announces a new product designated as "Steady-Volt". This is a new type of regulator for maintaining constant voltage for laboratory apparatus, production testing and heating equipment, electronic instruments, and other applications where a constant voltage is essential. The input voltage may vary from 95 to 130 volts. The output voltage is main-

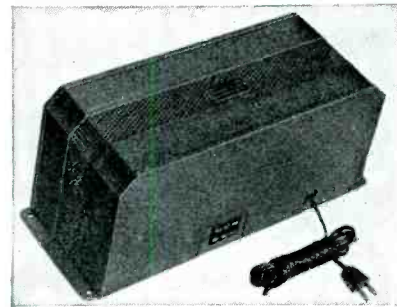

tained within one per cent accuracy. There is a negligible variation in output voltage from no load to full load, permitting the use of the device at any rating up to its maximum value. A triple output receptacle is provided for 110, 115, or 120 volts output. The operation of the regulator involves no moving parts, because it is based on a magnetic principle of instantaneous response, to correct either transient or chronic line voltage fluctuations.

SEARCHLIGHT SECTION

EMPLOYMENT • BUSINESS • OPPORTUNITIES • EQUIPMENT—USED or RESALE

UNDISPLAYED RATE:

10 cents a word, minimum charge \$2.00.
(See 1 on box Numbers.)

Positions Wanted (full or part-time salaried employment only), one-half the above rates.
Proposals, 50 cents a line an insertion.

NEW ADVERTISEMENTS received by 10 A.M. February 26th will appear in the March issue, subject to limitations of space available.

INFORMATION:

Box Numbers in care of our New York, Chicago or San Francisco offices count 10 words additional in undisplayed ads.

Discount of 10% if full payment is made in advance for four consecutive insertions of undisplayed ads (not including proposals).

DISPLAYED—RATE PER INCH:

The advertising rate is \$6.00 per inch for all advertising appearing on other than a contract basis. Contract rates quoted on request. An advertising inch is measured ¾ inch vertically on one column, 3 columns—30 inches—to a page. E.

POSITION VACANT

RADIO or Electrical Engineers wanted for permanent positions on staff of Washington Institute of Technology. Applications held confidential. Address McLachlen Building, Washington, D. C.

POSITIONS WANTED

(See also "Selling Opportunities Wanted")

ENGINEER: Eleven years broadcast experience, studio and transmitter construction and operation. Excellent references. Desire eastern connection. PW-265, Electronics, 520 N. Michigan Ave., Chicago, Ill.

RADIO ENGINEER, BS degrees in Mechanical and Electrical engineering and MS degree in Communication engineering. 2½ years experience in broadcast station. Age 25, single, radio-telephone first license. Some machine shop and electronic development experience. PW-266, Electronics, 520 N. Michigan Ave., Chicago, Ill.

FIRST TELEGRAPH and first telephone licenses. Five years experience including broadcasting. Age 27. Married. No children. Any location or offer considered confidentially. PW-267, Electronics, 68 Post Street, San Francisco, Cal.

WANTED

ANYTHING within reason that is wanted in the field served by Electronics can be quickly located through bringing it to the attention of thousands of men whose interest is assured because this is the business paper they read.

SELLING OPPORTUNITIES OFFERED—WANTED

Selling Agencies—Sales Executives
Salesmen—Additional Lines

OPPORTUNITIES WANTED

For best informed sales representative in Government contract work write Riddell, 300 B-st., S.E., Washington, D.C.

WANTED NEW LINES FOR EXPORT. Exporter with well established record in Electronics and precision instrument field seeks new lines for Export World-wide connections. SA-260, Electronics, 330 W. 42nd Street, N. Y.

Sales Manager of national known Electrical Manufacturer will enter Representative field about April 1st. Fine technical background with excellent clientele from New York to Washington, D. C. Offers manufacturers of quality apparatus complete Jobber and Industrial Sales Engineering coverage. All replies will be held in strictest confidence. RA-264, Electronics, 330 W. 42nd St., New York, N. Y.

HIGH GRADE USED ELECTRON TUBE MACHINERY

Huge Stock of Every Type and Variety

KAHLE ENGINEERING CORPORATION
Specialists in Equipment for the manufacture of Neon Tubes, Radio Tubes, Incandescent Lamps, Photo Cells, X-ray Tubes, etc.

900 DeMott St., North Bergen, N. J.

DEPENDABLE

Used ELECTRONIC TUBE EQUIPMENT

Complete line of used equipment for the manufacture of Radio Tubes, Neon Tubes, Incandescent Lamps, etc. Write for Bulletin showing 25 to 75% savings.

CALLITE TUNGSTEN CORPORATION
formerly Eisler Electric Corp.
534 39th Street, Union City, N. J.

WANTED! LABORATORY AND MEASURING EQUIPMENT

General Radio, Weston, etc. Must be in good condition and the price reasonable. Write

W-263, Electronics
330 W. 42nd St., New York, N. Y.

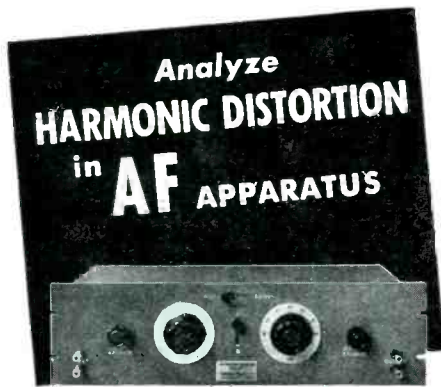

Simple
Efficient
Convenient & Economical

In a direct reading you get the amplitude of the total harmonic distortion in decibels below the fundamental. Observe the character of the distortion while making changes in the circuit ... detect "peak clipping," sharp cut-off, transformer saturation and parasitics. These and many more important observations and analyses can be made quickly and accurately with this new and decidedly better distortion analyzer.

Write today for free literature. Ask for bulletin T-102. Complete specifications and technical data. Instruments available in cabinet models or for relay rack mounting.

Get full information without obligation. Put this instrument to work to save you time and money in development and production.

HEWLETT-PACKARD CO.
Laboratory Instruments
481 Page Mill Road • Palo Alto, California

Engineered to meet
Exacting Specifications
EICOR
DYNAMOTORS



Approved and Selected
for Aircraft, Marine and
Mobile Radio

You can be sure of smooth, trouble-free performance and long life when Eicor-built Dynamotors are on the job! There's a unit for every need—from the smallest in size to the largest in output. Send us your specifications.

Also Eicor Power Plants, Rotary Converters and Small D.C. Motors.

EICOR ★ 1050 Adams St., Chicago, U.S.A.
Export: Ad Auriema, 116 Broad St., New York



Broadcasting "On Location"

(Continued from page 42)

certainty concerning reception or production. This transmitter should be capable of from 50 to 100 watts output. In current use at WFBL is a Temco "50".

Auxiliary Equipment

We also have two pack type transmitters of extremely low power designed for u-h-f work. One of these has been an outstanding performer since its construction three years ago. This is an original, crystal-controlled transmitter especially designed for high quality program work and capable of 100 per cent modulation of a 2-watt carrier from low level microphones. Its weight with batteries is 35 pounds. The antenna is a short vertical rod. The other pack is a conventional, commercial unit used merely for communication purposes.

Several disagreeable factors unite to make this type of transmission far from modern in results. The extremely low power, high ignition noise level, poor performance of receivers at these frequencies and shadow effects of terrain, buildings, etc. are some of the disadvantages.

With the thought in mind that perhaps we might find a compromise between power and portability, time was devoted to the designing of a novel type "combination" u-h-f and intermediate frequency transmitter, one which could easily be transported in almost any vehicle and be made to replace the pack transmitters in most cases. (See ELECTRONICS, October 1939.)

The outfit was constructed in two small suitcase carrying cases. One housed the transmitter and the other the power supply. Power output is between 15 and 20 watts.

The transmitter has interchangeable r-f units with which it is possible to cover both ultrahigh and intermediate frequencies. However, the intermediate frequencies have proved most outstanding even when working mobile into a short

COILS

Electrical Windings



A COMPETENT and experienced organization devoted to the design and manufacture of coil windings. Paper interlayer sections—form wound and bobbin wound coils.

Equipped for prompt production on quantity or small orders.

N. OINION, Pres. & Gen.-Mgr.

REPRESENTATIVES

W. A. JGRDAN 295 Madison Ave., New York, N. Y.	PARAGON SALES CO. (C. H. Fryburg) 402 Cherry St., Philadelphia, Pa.
GILBERT GISLASON 82 St. Paul St., Rochester, N. Y.	A. J. LOEB SALES CO. 1836 Euclid Ave., Cleveland, Ohio

MAGNETIC WINDINGS COMPANY
Sixteenth and Butler Streets EASTON, PENNA.

PROFESSIONAL SERVICES

(Rates on Application)

ELECTRICAL TESTING LABORATORIES

Characteristics of Vacuum Tubes
Tests of photo cells, glow lamps, crater lamps,
Tests of electronics and optical devices
East End Avenue and 79th Street
New York, N. Y.
Phone: Butterfield 8-2600

HAROLD J. McCREARY

Mem. A.I.E.E. & W.S.E.
Consulting Engineer

Laboratory Facilities
Research Electronics
Development Television
Design Radio
Factory Practise Railroad Signaling
Patent Studies Telephony
105 W. Adams St. Phone STate 4003 Chicago, Ill.

JOSEPH RAZEK, PH.D.

Consulting Physicist

Electrical and Mechanical Engineering Problems
Instruments and Control Devices Electronics
Specialist in Colorimetry, Spectrophotometry and
Industrial Color Control
Laboratory and Shop Facilities
430 Greenview Lane Llanerch, Pa.

F. H. SHEPARD, JR.

CONSULTING ENGINEER
ELECTRONIC APPLICATIONS

Specializing In:
Industrial Control Special Amplifier Design
Follow-Up Devices Photoelectric Applications
Radio and Carrier Operated Remote Control
6167 Cedar Ave., Merchantville, N. J.
Telephone Merchantville 1111

vertical antenna. Distances up to 10 miles have been covered with this antenna and a 100 per cent broadcastable signal at the receiving point on frequencies around 2-3 Mc.

Obviously, a loading unit had to be designed as an integral part of the transmitter. Any wire can be matched from 10 feet in length upward. A 12-foot vertical rod which clamps anywhere has been in extensive use with results beyond expectations.

This transmitter is dynamotor-battery operated, uses either high or low impedance microphones, is quiet in operation, and operates stably and dependably anywhere. Signal fading is rare and almost any receiver can be used as a pick-up.

On the Golf Course

Golf course coverage becomes almost a certainty with this outfit, leaving only the problem of transportation. Many courses can be traversed with a car if necessary especially if equipped with low pressure tires. Any light vehicle that can be adapted to golf course work is satisfactory.

However, in view of the necessity for reliability in covering Syracuse's most important golf event, the Eastern Amateur, some other means of transportation was sought out. Although the course used for this tournament is for the most part flat and open, there always exists the possibility of heavy rains softening the course so that a car would be unable (or would not be permitted) to negotiate it.

There are several manufacturers of golf course tractors, all of them likely to display a willingness to exploit their product by loaning it for broadcast purposes. WFBL obtained a suitable tractor from the Toro Company which remodeled it to meet requirements. The small rear deck was cleared to accommodate the equipment. A protective railing of iron pipe was erected which also served as a hand rail for the announcers and commentators who stand on a specially built step-platform in the rear. The antenna rod is clamped to the railing and ground made to the chassis. Motor noise is not objectionable and in fact the little background which prevails only succeeds in lending the proper "atmosphere".

CONTACTS

FOR THE FIELD OF ELECTRONICS

We manufacture a complete line of equipment

SPOT WELDERS, electric, from ¼ to 500 KVA
 TRANSFORMERS, special and standard types
 INCANDESCENT LAMP manufacturing equipment
 RADIO TUBES, ex-ray cathode ray, photo cells
 ELECTRONIC EQUIPMENT, vacuum pumps, etc.
 WET GLASS slicing and cutting machines for laboratory use
 GENERAL GLASS working machines and burners
 COLLEGE GLASS working units for students and laboratory

EISLER ENGINEERING COMPANY, CHAS. EISLER, Pres.
 751 So. 13th St. (near Aven Ave.) Newark, New Jersey



CRYSTALS by HIPOWER

The Hipower Crystal Company, one of America's oldest and largest manufacturers of precision crystal units, is able to offer the broadcaster and manufacturer attractive prices because of their large production and the exclusive Hipower grinding process. Whatever your crystal need may be, Hipower can supply it. Write today for full information.

HIPOWER CRYSTAL CO.
 Sales Division—205 W. Wacker Drive, Chicago
 Factory—2035 Charleston Street, Chicago, Ill.

SIGNICO

SIGNAL & INDICATOR PILOT LIGHTS
 for all electrical devices.

WRITE FOR CATALOGUE showing a complete line of assemblies for all purposes.

SIGNAL INDICATOR Corp.
 140 CEDAR ST. NEW YORK, N. Y.



FINE RIBBONS
 of Tungsten, Molybdenum and Special Alloys
 To your specifications
H. CROSS
 15 BEEKMAN ST. NEW YORK

A C T O N E

CUTTING STYLI

For recording direct on all coated aluminum or paper base discs. Individually lapped for a quiet, high quality cut.

H. W. ACTON CO., Inc., 370 7th Ave., New York



QUALITY ABOVE ALL

SOLAR

CAPACITORS

Write for Catalog
SOLAR MFG. CORP.
 BAYONNE, N. J.

MICROMETER for checking transmitters, from 1.5 to 56 mc., within 0.01 per cent.

METER

LAMPKIN LABORATORIES
 —Bradenton, Fla., U. S. A.—



"WHAT CAN IT DO FOR ME"

Advertising that is read with this thought in mind, may provide the solution to a problem that has kept you awake nights for weeks.

Remember, back of the signature of every Electronic advertiser is another organization, whose members have thought long and hard about your business in the course of introducing and applying their products or services to your industry.

If their offerings can improve the quality of your company's product . . . or save your company's money . . . they can contribute to your company's income.

We all know, "It pays to advertise." It pays just as big to investigate what is advertised!

Each month, Electronics advertisers, old and new, invite you and over 14,000 other subscribers to investigate further the advantages they can provide.

Departmental Staff
ELECTRONICS

NEW ALL-PLASTIC SWITCHBOARD LAMP
 FOR SINGLE HOLE PANEL MOUNTING
 Write for Ten Page Catalog

Type T2 Unit

The shell is molded in the same color as the lens-cap to prevent error in replacement. . . furnished with a 24 volt slide-base lamp, (.038 amp.) . . . used with a series resistor assembly for operation on voltages up to 440 . . . five different colors . . . brilliant 180 degree visibility . . . low in cost.

Distributed nationally by
GRAYBAR ELECTRIC CO.
 H. R. KIRKLAND CO., Morristown, N. J.



FILTERS—EQUALIZERS

Lattice Bridged-T Paralleled-T etc.
 Designed and manufactured
 Submit your filter problem

HOLLYWOOD TRANSFORMER CO.
 7364 Melrose Ave. Hollywood, Calif.

KURMAN

LEACH

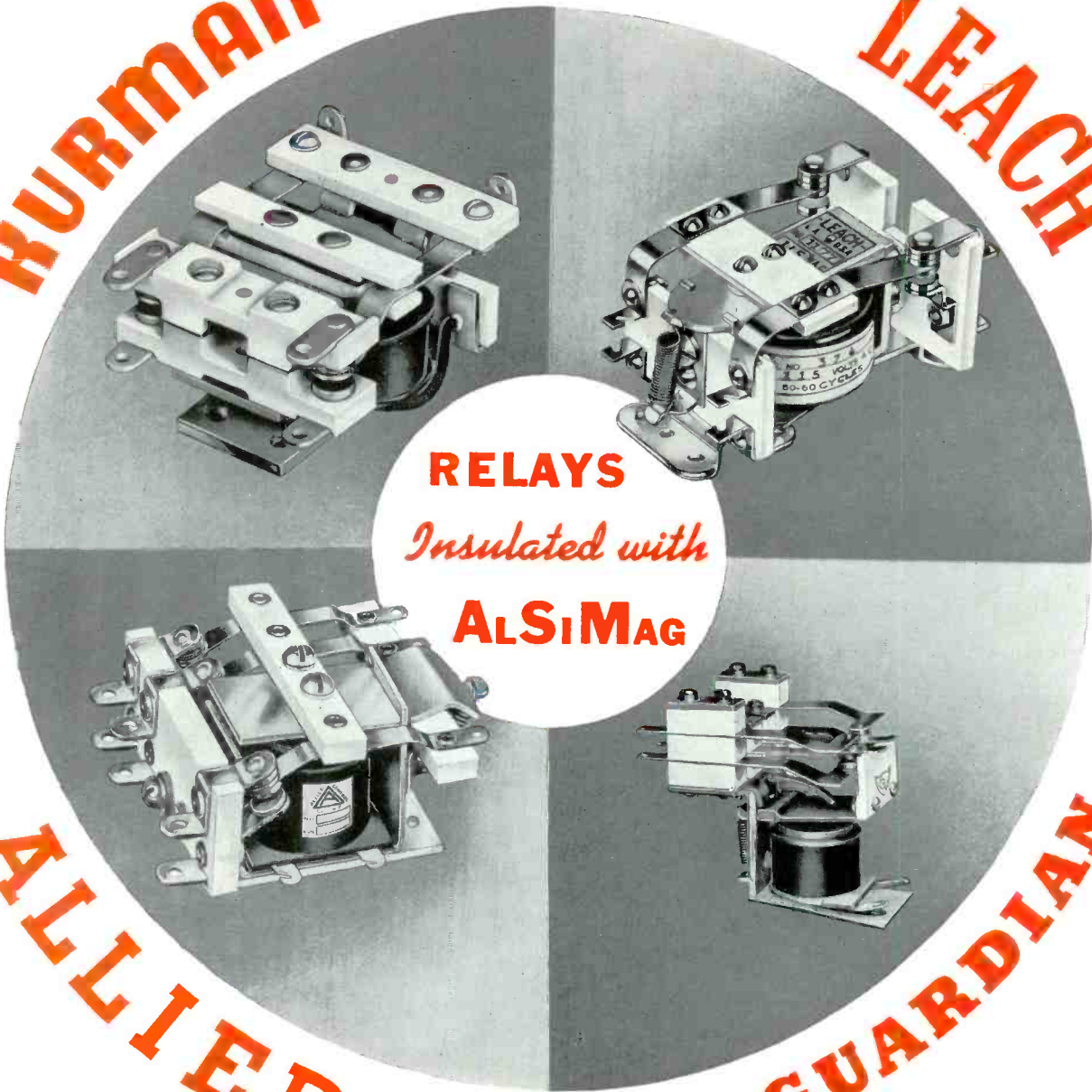

RELAYS
Insulated with
ALSiMAG

ALLIED

GUARDIAN

The Best Relays have the Best Insulation.. **ALSiMAG**

The absolute and permanent rigidity of ALSiMag insulators holds spring assemblies of relays in positive alignment. This enables contacts to "make" and "break" without hesitancy or chattering. High contact pressure is easily handled due to ALSiMag's outstanding mechanical strength. ALSiMag meets the requirements for R. F. insulation. It falls within the specifications of Army and Navy. When you specify ALSiMag, you specify the best in insulation.

ALSiMAG
Trade Mark Reg. U. S. Pat. Off.

FROM CERAMIC HEADQUARTERS

AMERICAN LAVA CORPORATION • CHATTANOOGA • TENNESSEE
 CHICAGO • CLEVELAND • NEW YORK • ST. LOUIS • LOS ANGELES • SAN FRANCISCO • BOSTON • PHILADELPHIA • WASHINGTON, D. C.

Admiral
DEWALD

Andrea

AUTOMATIC

Detrola
Gilfillan

Emerson

FADA

Farnsworth

... **RCA**
PREFERRED TYPE TUBES
PROGRAM ROLLS ON

GAROD

Sentinel

Hallicrafters
Radiola
Sonora



Pilot

PACKARD-BELL

RCA Victor

WURLITZER

Stromberg-Carlson

IN 1940, for the first time in history, over 5,000,000 new radio receivers used *Preferred Type Tubes* . . . 27 million Preferred Type Tubes. These 5,000,000 radio receivers represented nearly half the Industry's total output in 1940.

What are the *results* of this tremendous trend toward standardization? Inventories are simplified: for distributors, dealers and servicemen as well as for the manufacturers who have endorsed and adapted this Program. Deliveries have been speeded up... for the tube manufacturer can ship from *stock*.

Mass-production concentrated on more tubes of fewer types means tubes of better and more uniform quality at the lowest possible cost.

The more widespread the adoption of this Program, the more the Industry gains. The RCA Preferred Type Tubes Program is not only the *best* suggestion ever advanced to solve the problem of "too many tube types"... it is a *really* constructive step! It deserves the support of the entire industry... for it benefits the entire industry.



Feature the radio receivers that are equipped with Preferred Type Tubes!



Preferred Type Tubes

RCA Manufacturing Company, Inc., Camden, N. J. • A Service of the Radio Corporation of America • In Canada, RCA Victor Company, Ltd., Montreal